

For Sales & Service Contact

geotech

2650 E. 40th Ave. • Denver, CO 80205
Phone 303-320-4764 • Fax 303-322-7242

1-800-833-7958

www.geotechenv.com

03 Series: GP-03 Version Operator's Manual

Part Number: 71-0303

Revision: C

Released: 9/26/18

WARNING

Read and understand this instruction manual before operating instrument. Improper use of the gas monitor could result in bodily harm or death.

Periodic calibration and maintenance of the gas monitor is essential for proper operation and correct readings. Please calibrate and maintain this instrument regularly! Frequency of calibration depends upon the type of use you have and the sensor types. Typical calibration frequencies for most applications are between 1 and 3 months, but can be required more often or less often based on your usage.

Warranty

RKI Instruments, Inc. warrants the GP-03 Single Gas Monitor sold by us to be free from defects in materials, workmanship, and performance for a period of two (2) years from the date of shipment from RKI Instruments, Inc. This includes the instrument and the original sensor. Replacement parts are warranted for one (1) year from the date of their shipment from RKI Instruments, Inc. Replacement sensors are warranted for two (2) years from the date of their shipment from RKI Instruments, Inc. Any parts found defective within their warranty period will be repaired or replaced, at our option, free of charge. This warranty does not apply to those items, which by their nature, are subject to deterioration or consumption in normal service, and which must be cleaned, repaired, or replaced on a routine basis. Examples of such items are as follows:

Absorbent cartridges

Filter elements, disks, or sheets

Pump diaphragms and valves

Warranty is voided by abuse including mechanical damage, alteration, rough handling, or repair procedures not in accordance with the instruction manual. This warranty indicates the full extent of our liability, and we are not responsible for removal or replacement costs, local repair costs, transportation costs, or contingent expenses incurred without our prior approval.

THIS WARRANTY IS EXPRESSLY IN LIEU OF ANY AND ALL OTHER WARRANTIES AND REPRESENTATIONS, EXPRESSED OR IMPLIED, AND ALL OTHER OBLIGATIONS OR LIABILITIES ON THE PART OF RKI INSTRUMENTS, INC. INCLUDING BUT NOT LIMITED TO THE WARRANTY OF MERCHANTABILITY OR FITNESS FOR A PARTICULAR PURPOSE. IN NO EVENT SHALL RKI INSTRUMENTS, INC. BE LIABLE FOR INDIRECT, INCIDENTAL, OR CONSEQUENTIAL LOSS OR DAMAGE OF ANY KIND CONNECTED WITH THE USE OF ITS PRODUCTS OR FAILURE OF ITS PRODUCTS TO FUNCTION OR OPERATE PROPERLY.

This warranty covers instruments and parts sold to users only by authorized distributors, dealers, and representatives as appointed by RKI Instruments, Inc.

We do not assume indemnification for any accident or damage caused by the operation of this gas monitor and our warranty is limited to replacement of parts or our complete goods.

Table of Contents

Introduction	6
Specifications	7
Description	9
Case	9
Sensor Gasket, Sensor Membrane, and H ₂ S Filter Disk	10
Combustible Gas Sensor	10
LCD	11
Control Buttons	11
Alarm LED	11
Buzzer	12
Vibrator	12
IrDA Port	12
Printed Circuit Boards	12
Batteries	12
Protective Rubber Boot	13
Alligator & Belt Clips	14
Start Up	15
Start-up Procedure	15
Performing a Fresh Air Adjustment	22
Turning Off the GP-03	23
Operation	23
Measuring Mode	23
Combustible Gas Detection	23
Adjusting the Buzzer Volume	25
Display Mode	26
Alarms	27
Data Logging	32
03 Series User Setup Program	32
Calibration Mode	33
Calibration Frequency	33
Using Calibration Mode	33
Setting the Date and Time	35
Performing a Fresh Air Adjustment	35
Performing an Automatic Span Adjustment in A--CAL	36

Performing an Easy Span Adjustment in E--CAL	41
Performing a Manual Span Adjustment in M--CAL	46
Performing a Bump Test in BUMP	49
Viewing the Instrument's Firmware Version	54
Setup Mode.	56
Using Setup Mode.	56
Setting the Date and Time in DATE	58
Performing a Fresh Air Adjustment in AIR.	58
Performing an Automatic Span Adjustment in A--CAL	58
Performing an Easy Span Adjustment in E--CAL	58
Performing a Manual Span Adjustment in M--CAL	59
Setting the Alarm Points	59
Adjusting the Bump Test Limit Check Setting	60
Setting the Password	61
Maintenance	63
Troubleshooting	63
Replacing or Recharging the Batteries	65
Replacing the Sensor	67
Replacing the Sensor Membrane and H ₂ S Filter Disk	69
Parts List.	71

WARNING: Understand this manual before operating the GP-03. Substitution of components may impair intrinsic safety. To prevent ignition of a hazardous atmosphere, batteries must only be changed in an area known to be nonhazardous. This unit has not been tested in an oxygen enriched atmosphere (above 21%).

Introduction

Using an advanced microprocessor controlled detection system, the GP-03 Single Channel LEL Gas Monitor detects the presence of combustible gas (e.g., methane, CH₄) as a percentage of LEL (lower explosive limit). The GP-03's compact size and easy-to-use design make it ideally suited for a wide range of applications, including sewage treatment plants, tunnels, hazardous waste sites, petrochemical facilities, oil fields, mines, and chemical plants. The GP-03 is even small enough to be placed conveniently in a pocket. The GP-03 offers the following features:

- Compact design
- Fast, accurate response with backlit digital liquid crystal display (LCD)
- Visual, audible, and vibration alarms
- Microprocessor control for reliability, ease of use, and advanced capabilities
- Resistance to RF (radio frequency) interference
- Datalogging including interval trend data and alarm trend data
- Peak indication
- Over range alarm
- Gas, battery, sensor failure, and system failure alarms
- Rotatable alligator clip for “hands free” gas monitoring, belt clip optional
- CSA certification for intrinsic safety in Class I, Division I, Groups A, B, C, and D hazardous atmospheres

WARNING: The GP-03 detects combustible gas, which can be dangerous or life threatening. When using the GP-03, you must follow the instructions and warnings in this manual to assure proper and safe operation of the unit and to minimize the risk of personal injury. Be sure to maintain and calibrate the GP-03 as described in this manual.

Specifications

Table 1: GP-03 Specifications

Target Gas	Combustible Gas, Methane (CH ₄) Calibration Standard*
Detection Range	0 to 100% LEL
Display Increment	1% LEL
Detection Principle	Catalytic Combustion Method
Alarm Points	<ul style="list-style-type: none"> • Low Alarm: 10% LEL • High Alarm: 50% LEL • Over Range: 100% LEL
Sampling Method	Diffusion
Response Time	T90 in 30 seconds
Accuracy	± 5% of reading or ± 2% LEL (whichever is greater)
Indication	Digital LCD
Safety/Regulatory	<div style="text-align: center;">  <p>C US 186718</p> </div> <p>CSA classified, "C/US", as Intrinsically Safe. Exia. Class I, Groups A, B, C, & D. Temperature Code T3C.</p>
Power	<ul style="list-style-type: none"> • Two AAA size alkaline batteries standard, Duracell MN2400 or PC2400 • Two AAA size Ni-MH batteries optional, Panasonic Eneloop BK-4MCC
Continuous Operating Hours	<ul style="list-style-type: none"> • Alkaline batteries: 35 hours at 25 °C, no alarms or backlighting • Ni-MH batteries: 30 hours at 25 °C, no alarms or backlighting
Case	High-impact plastic, dust and weather proof
Standard Accessories	<ul style="list-style-type: none"> • Rubber protective boot • Alligator clip

Table 1: GP-03 Specifications

Optional Accessories	<ul style="list-style-type: none">• Calibration adapter• Calibration kit• Belt clip• Wrist strap• IrDA/USB cable for downloading data to computer• Product CD, includes 03 Series Datalogging Program and 03 Series User Setup Program
Dimensions and Weight	2.2" (54mm) W x 2.6" (67mm) H x 0.9" (24mm) D; 2.8 oz. (80 g)
Operating Temp. & Humidity	-20°C to +50°C, below 90% RH (non condensing)
<p>*The GP-03 is also available set up for general hydrocarbons and calibrated to a combustible gas other than methane, such as isobutane. Consult RKI Instruments, Inc. for further information.</p>	

Description

This section describes the components of the GP-03.

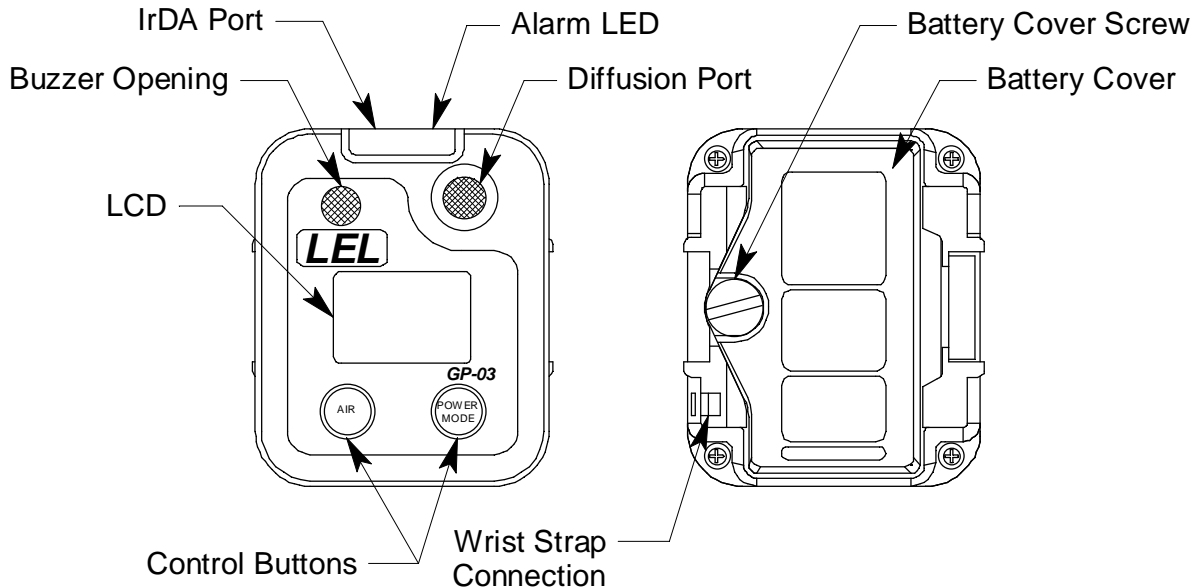

Figure 1: Components of the GP-03

Case

The GP-03's sturdy, high-impact plastic case is blue and consists of a front case and a rear case. The case is suitable for use in many environmental conditions, indoors and out. The unit is dust proof and weather resistant.

The front case has an LCD (liquid crystal display) that shows various indications. Below the LCD are two black control buttons. The left button is labeled "AIR" and the right button is labeled "POWER MODE".

The buzzer opening is located in the top left corner of the front case. To the right of the buzzer is the diffusion port for the sensor.

The alarm LED lens is located at the top of the front case.

The battery compartment is located in the rear case. Access to the compartment is accomplished by turning the captive battery cover screw counterclockwise and by removing the battery cover.

There are two spring bars on the rear case. One is on the left and one is on the right. They are the same type of spring bar that is used to retain a watch band and are used to mount the alligator clip or optional belt clip.

A feature in the lower left corner of the rear case is used to install the optional wrist strap.

Sensor Gasket, Sensor Membrane, and H₂S Filter Disk

The sensor gasket seals against the sensor and retains the sensor membrane and filter disks.

Two types of paper-like filter disks may be installed beneath the sensor gasket. The white disk is the sensor membrane. The dark red disk is the H₂S filter disk.

The sensor membrane is held in place by the sensor gasket and fits into a recessed area on the inside of the front case. The sensor membrane covers the diffusion port and protects the sensor from dirt and moisture. The sensor membrane should be inspected periodically and replaced if contaminated by dirt or moisture. See “Replacing the Sensor Membrane and H₂S Filter Disk” on page 69 for sensor membrane replacement instructions.

The H₂S filter disk is not installed in the GP-03 as shipped from the factory. It can be installed to protect the combustible gas sensor from H₂S exposure if H₂S will be present in the monitoring area. If monitoring for a gas other than methane, consult RKI Instruments, Inc. before installing an H₂S filter disk. Some combustible gases can be absorbed by the H₂S filter disk. One H₂S filter disk fits in between the sensor membrane and the sensor gasket. If installed, it prevents H₂S in the ambient air from reaching the unit's combustible gas sensor. Removing H₂S that is present in the monitored air prolongs the life of the sensor. The H₂S filter disk is dark red in color and although it may darken over time, its color is not indicative of remaining filter life. The H₂S filter disk can absorb H₂S for 33 ppm hours and should be replaced after that much exposure. With this many ppm hours of absorption, the H₂S filter disk should be replaced after 80 minutes of exposure to 25 ppm H₂S. This equates to replacing the H₂S filter disk after 40 2-minute calibrations with a cylinder containing 25 ppm H₂S. If H₂S exists in the monitoring environment, the H₂S filter disk will have to be replaced more frequently.

NOTE: See “Combustible Gas Detection” on page 23 for a discussion of when the H₂S filter disk should be used and how it affects detection of certain gases.

Combustible Gas Sensor

The combustible gas sensor detects combustible gas and vapors in the atmosphere with a catalytic element. The reaction of gas with oxygen on the catalyst causes a change in the resistance of the element, which affects the current flowing through it. The current is amplified by the GP-03's circuitry, converted to a measurement of combustible gas concentration, and displayed on the LCD.

CAUTION: Do not expose the combustible gas sensor to high concentrations of combustible gas such as those found in a butane lighter. Exposure to high concentrations of combustible gas may adversely affect the performance and life of the combustible gas sensor.

LCD

The LCD is visible through the front case. When the GP-03 is in Measuring Mode, the target gas concentration, battery condition, and alarm indications are displayed on the LCD. Various other items are displayed when the LCD is in other modes, such as Calibration Mode. When either of the two control buttons are pressed, the LCD backlight comes on for 20 seconds.

Control Buttons

Below the LCD are two control buttons: POWER MODE and AIR. The POWER MODE button turns the GP-03 on and off. The functions performed by the control buttons are summarized in the following table:

Table 2: GP-03 Control Buttons

Button	Function
POWER MODE	<ul style="list-style-type: none">• Turns the unit on and off.• Turns the LCD back light on.• Resets the alarm circuit (gas alarms).• Enters Display Mode.• Enters Calibration Mode with the AIR button.• Enters Setup Mode with the AIR button.
AIR	<ul style="list-style-type: none">• Turns the LCD back light on.• Adjusts LCD reading when the fresh air adjustment is performed.• Enters Calibration Mode with the POWER MODE button.• Enters Setup Mode with the POWER MODE button.• Increases or decreases settings when the unit is in Calibration Mode or Setup Mode.

Alarm LED

The GP-03 has one red alarm LED. It alerts you to gas, low battery, and sensor failure alarms. The alarm LED is located at the top of the front case beneath a clear lens.

Buzzer

A solid-state electronic buzzer is mounted inside the GP-03. An opening in the top left corner of the front case allows the buzzer's sound to emanate from the case. The buzzer sounds for gas alarms, unit malfunctions, and the dead battery alarm. It also serves as an indicator during normal use of the various LCD display options.

Vibrator

A vibrating motor (vibrator) is mounted inside the GP-03. The vibrator vibrates momentarily during the power-up sequence and for gas alarms.

IrDA Port

An infrared (IR) communications port is located just to the left of the alarm LED at the top of the front case beneath the clear lens. The data transmitted through the port is in standard IrDA protocol. A computer's infrared port or an IrDA/USB cable connected to a computer's USB port can be used to download data saved by the GP-03 to a computer using the 03 Series Data Logger Management Program. See the 03 Series Data Logger Management Program operator's manual for data logging and downloading instructions.

Printed Circuit Board

The primary function of the GP-03's printed circuit board is to amplify the signal sent to it from the sensor, convert the signal to a meaningful measurement of gas concentration, display the gas concentration on the LCD, store peak gas readings, and activate the alarm circuit if an alarm point has been reached. It monitors battery level, battery failure, and sensor failure. It also controls various operating modes of the unit.

NOTE: The printed circuit board contains no user serviceable parts.

Batteries

Two AAA-size alkaline batteries (standard) or two Ni-MH AAA batteries (optional) run the GP-03. At 25°C the alkaline batteries last at least 35 hours and the Ni-MH batteries last at least 30 hours. The battery icon on the LCD shows remaining battery life.

When the GP-03 detects low battery voltage, a low battery warning is activated. When battery voltage is too low for normal operation, the GP-03 sounds a dead battery alarm.

The alkaline and the Ni-MH batteries can be replaced by removing the battery cover on the rear case. Turn the captive battery cover screw counterclockwise to release the door. See "Replacing or Recharging the Batteries" on page 65 for detailed battery changing instructions.

WARNING: *To prevent ignition of a hazardous atmosphere, batteries must only be changed in an area known to be nonhazardous.*

AVERTISSEMENT: *Pour éviter l'inflammation d'une atmosphère dangereuse, les batteries doivent uniquement être modifiés ou facturés dans une zone connue comme non dangereuse.*

NOTE: Use of batteries not specified by RKI Instruments, Inc. will void the CSA classification and may void the warranty. See "Replacing or Recharging the Batteries" on page 65.

Protective Rubber Boot

A protective rubber boot is installed over the GP-03.

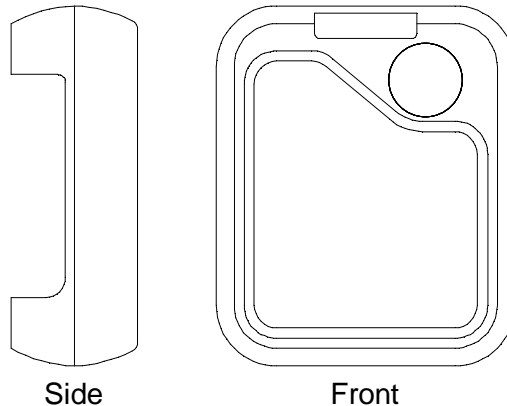

Figure 2: Rubber Boot

Alligator and Belt Clips

The GP-03 is available with two types of clips: the alligator clip (standard) and the belt clip (optional). The alligator clip is shown in Figure 3 below. The alligator clip can be used to attach the GP-03 to clothing or a belt. Teeth in the clip's jaws prevent the unit from slipping off. The clip can be rotated in 45 degree turns if necessary.

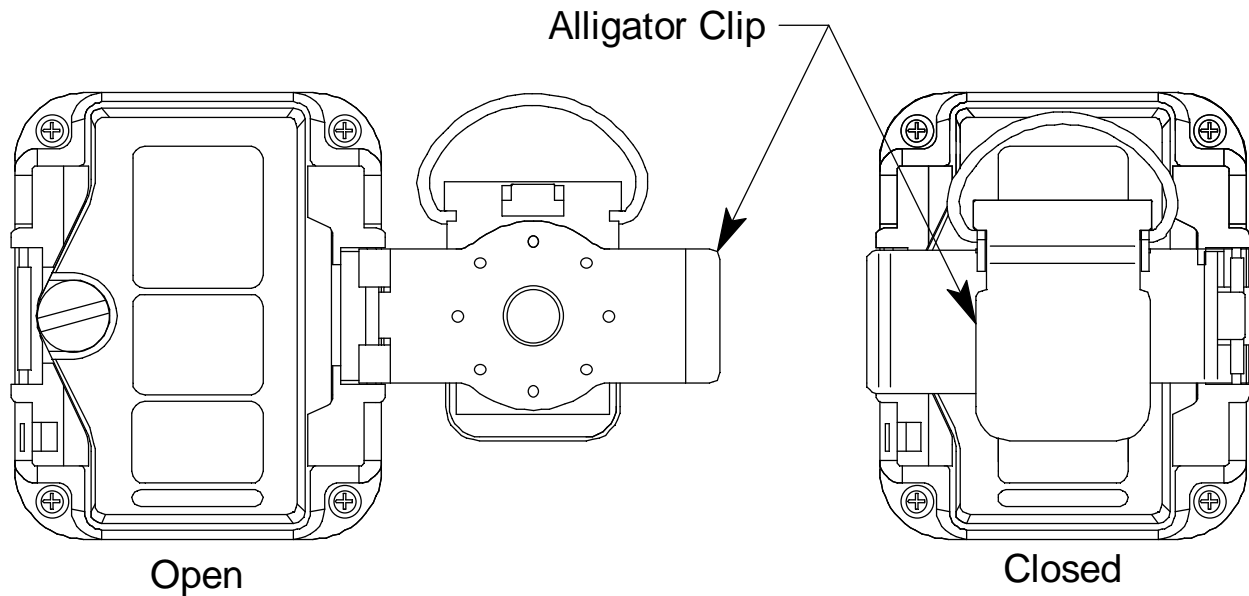

Figure 3: Alligator Clip

The belt clip is shown in Figure 4 below and is used to easily clip the GP-03 on a belt.

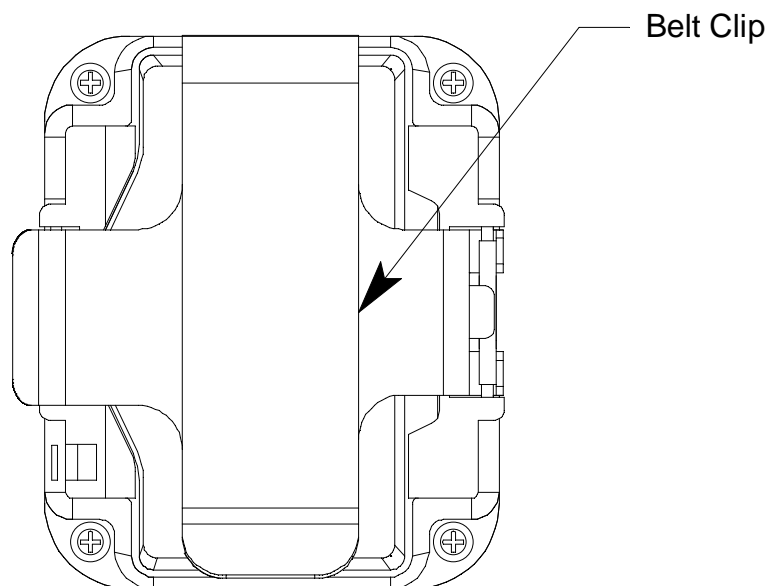

Figure 4: Belt Clip

Start Up

This section explains how to start up the GP-03 and to get it ready for operation.

CAUTION: Before each day's usage sensitivity must be tested on a known concentration of the combustible target gas, typically methane, equivalent to 25 - 50% of full scale. Accuracy must be within -0% to +20% of concentration. Accuracy may be corrected by following the calibration instructions in "Calibration Mode" on page 33.

Start-up Procedure

1. Press and briefly hold down the POWER MODE button. The backlight will turn on and all the display segments will turn on. Release the button when you hear a beep.
2. The vibrator vibrates and the alarm light flashes momentarily.
3. The initial startup screen depends on how **Bump Fail Behavior** is set. This parameter along with the **Cal. Limit Display** and **Cal. Limit Check** parameters mentioned in Step 5 and the **Auto Zero Adjustment** parameter mentioned in Step 12 below cannot be set using the GP-03's instrument menus, but are set using the 03 Series User Setup Program. See the 03 Series User Setup Program Operator's Manual for information regarding changing various instrument parameters that are not available for adjustment in the instrument's operating modes.
 - If **Bump Fail Behavior** is set to *None* (factory setting) or if it is set to *Can Not Use* and the most recently performed bump test passed, proceed to Step 5.
 - If **Bump Fail Behavior** is set to *Can Not Use* using the 03 Series User Setup Program and the most recently performed bump test failed, the following screen will appear.

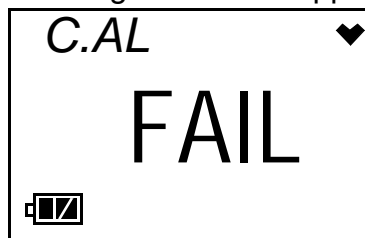

The instrument cannot be used until a successful bump test or calibration is performed. See "Calibration Mode" on page 33 for instructions.

4. If **Cal. Limit Display** is set to *Off*, proceed to Step 6.

5. If **Cal. Limit Display** is set to *On* (factory setting), the screen that appears next depends on how **Cal. Limit Check** is set.
- If the unit is due for calibration and **Cal. Limit Check** is set to *Confirm to use* (factory setting), then the following screen sequence will occur.

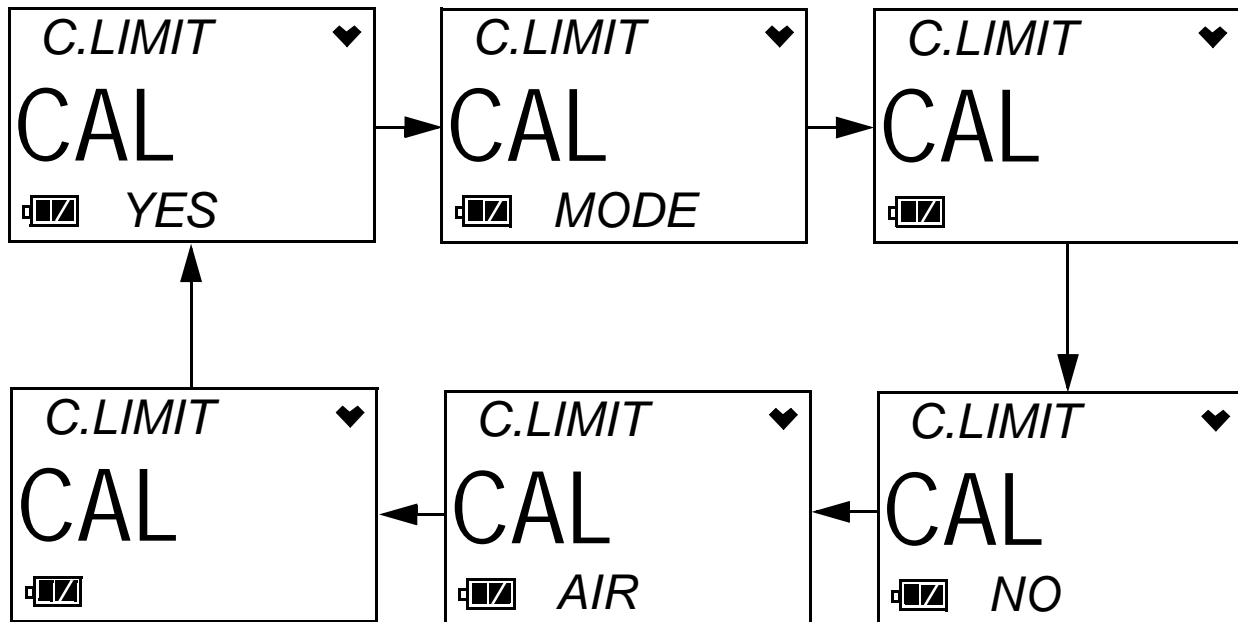

The alarm LED and buzzer will pulse several times.

To continue the startup sequence without performing a calibration, press and release the AIR button. Continue to Step 6.

To perform a calibration, press and release the POWER MODE button. Depending on the value entered into the **One Touch Cal Time** parameter using the 03 Series User Setup Program, the instrument will display either the A--CAL menu item or the E--CAL menu item in Calibration Mode. The instrument will display the A--CAL menu item in Calibration Mode. See "Calibration Mode" on page 33 for instructions.

WARNING: *You must press either the POWER MODE or AIR button to continue. If you do not press a button, the buzzer will continue to beep and the LED will continue to flash for 6 seconds every 5 seconds.*

- If the unit is due for calibration and **Cal. Limit Check** is set to *Can't use*, then the following screen sequence will occur.

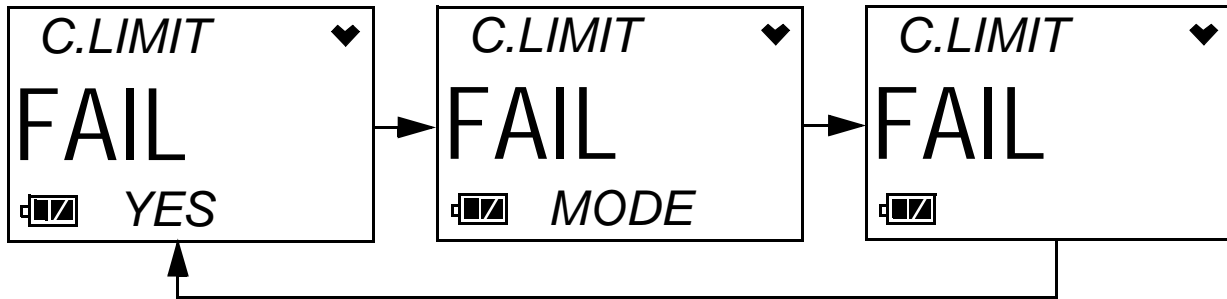

The alarm LED and buzzer will pulse several times. Press and release the POWER MODE button. Depending on the value entered into the **One Touch Cal Time** parameter using the 03 Series User Setup Program, the instrument will display either the A--CAL menu item or the E--CAL menu item in Calibration Mode. The above screen will remain on the display until the unit is either turned off or Calibration Mode is entered. The GP-03 cannot be used until a complete calibration has been performed either by selecting A--CAL, E--CAL, or M--CAL in the Calibration Mode menu. See “Performing an Automatic Span Adjustment in A--CAL” on page 36, “Performing an Easy Span Adjustment in E--CAL” on page 41, or “Performing a Manual Span Adjustment in M--CAL” on page 46 for calibration instructions.

WARNING: *You must perform a successful calibration in order to continue to normal operation. If you do not perform a successful calibration, the screen sequence will continue, the buzzer will continue to beep and the LED will continue to flash for 6 seconds every 5 seconds and the unit will not enter normal operation.*

- If a calibration is due and **Cal. Limit Check** is set to *None*, the sequence below will occur twice.

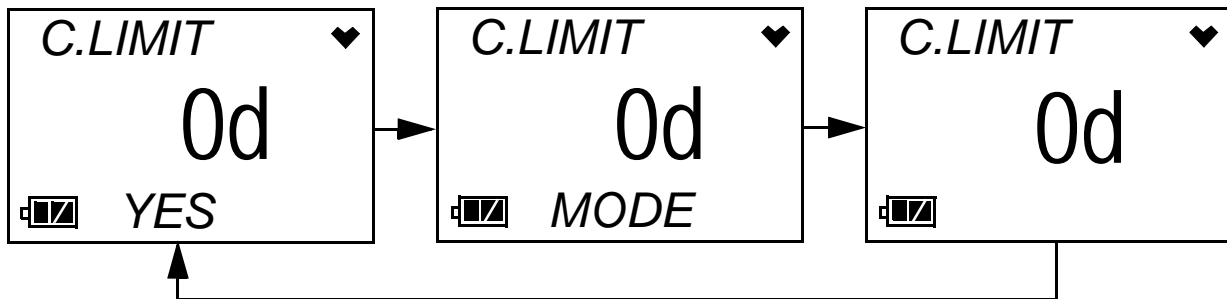

Press and release the POWER MODE button during this time to go

to the A--CAL or E--CAL menu item in Calibration Mode depending on the value entered into the **One Touch Cal Time** parameter of the 03 Series User Setup Program. If no button is pressed, the instrument will continue with the warmup sequence in Step 6 once the sequence shown above has finished.

- If a calibration is not due, then the following screens appears for a few seconds indicating when the next calibration is due. “NEXT” and “CAL” alternate on the bottom of the screen.

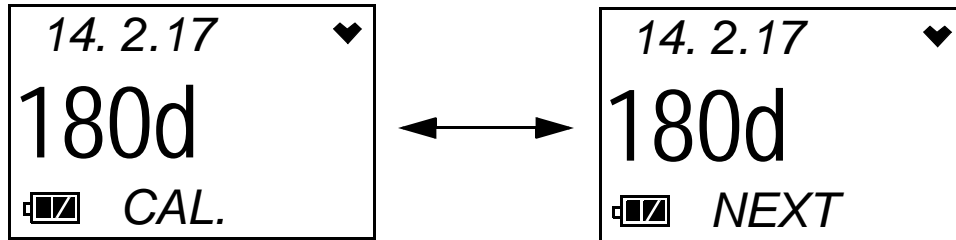

NOTE: The following screens in Step 7 only appear if **Bump Test Limit Display** is set to *On* using the 03 Series User Setup Program. The standard factory setting for this function is *Off*.

6. If **Bump Test Limit Display** is set to *Off* (factory setting), proceed to Step 8.
7. If **Bump Test Limit Display** is set to *On* using the 03 Series User Setup Program, the next screen will depend on how **Bump Test Limit Check** is set in Setup Mode or using the 03 Series User Setup Program.
 - If the unit is due for bump testing and **Bump Test Limit Check** is set to *Confirm to use* (factory setting), then the following screen sequence will occur.

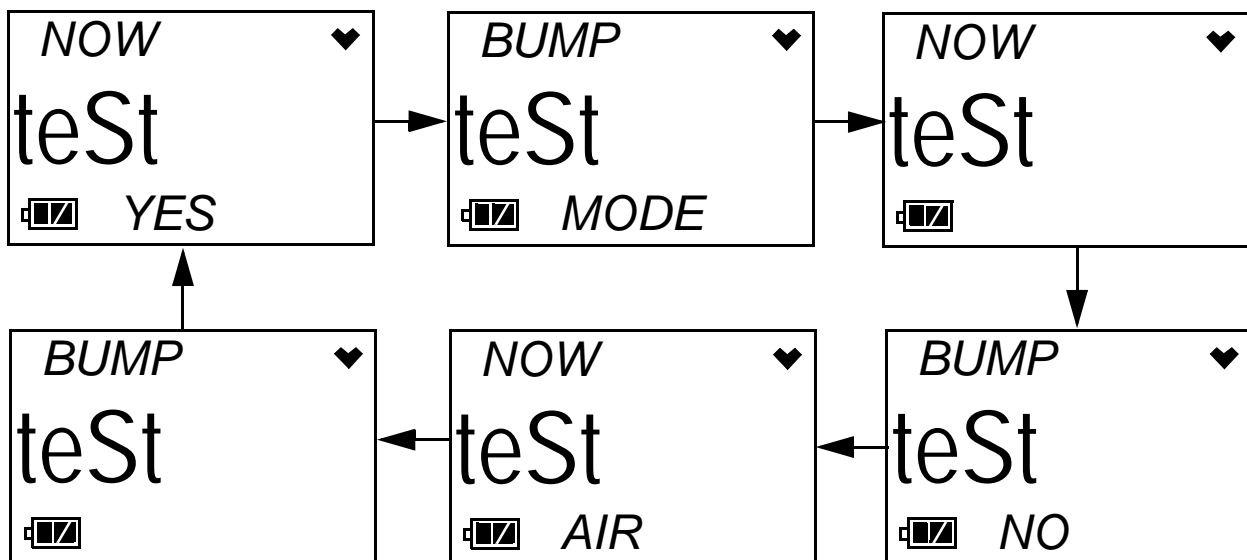

The alarm LED and buzzer will pulse several times.

To continue the startup sequence without performing a bump test, press and release the AIR button. Continue to Step 8.

To perform a bump test, press and release the POWER MODE button. The instrument will display the BUMP menu item in Calibration Mode. See “Performing a Bump Test in BUMP” on page 49 for instructions.

WARNING: You must press either the POWER MODE or AIR button to continue. If you do not press a button, the screen sequence will continue, the buzzer will continue to beep and the LED will continue to flash for 6 seconds every 5 seconds.

- If the unit is due for bump testing and **Bump Test Limit Check** is set to *Can't use*, then the following screen sequence will occur.

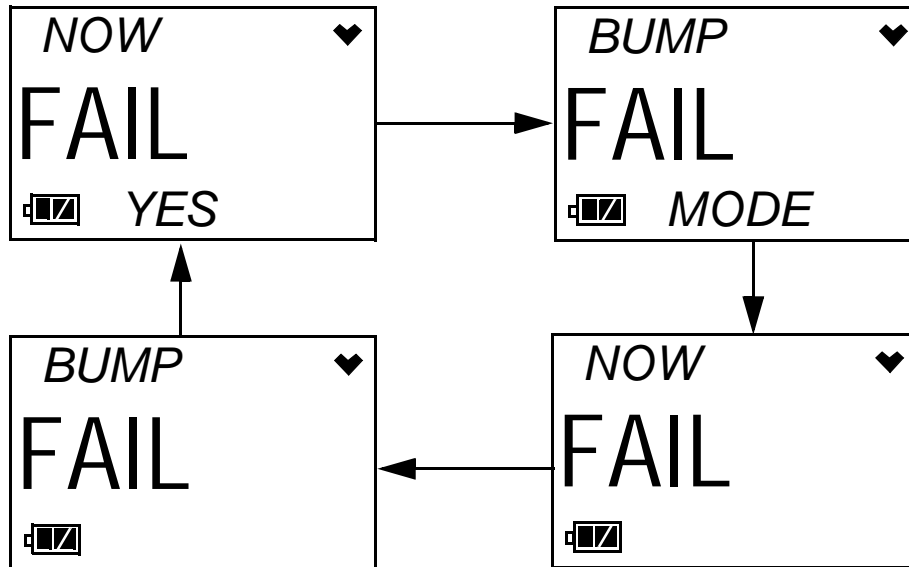

The alarm LED and buzzer will pulse several times. Press and release the POWER MODE button to go to the BUMP menu item in Calibration Mode. The above screens will remain on the display until the unit is either turned off or Calibration Mode is entered. The GP-03 cannot be used until a bump test has been performed. See “Performing a Bump Test in BUMP” on page 49 for bump test instructions.

WARNING: You must perform a successful bump test in order to continue to normal operation. If you do not perform a successful bump test, the buzzer will continue to beep and the LED will continue to flash for 6 seconds every 5 seconds and the unit will not enter normal operation.

- If a bump test is due and **Bump Test Limit Check** is set to *None*, the sequence below will occur twice.

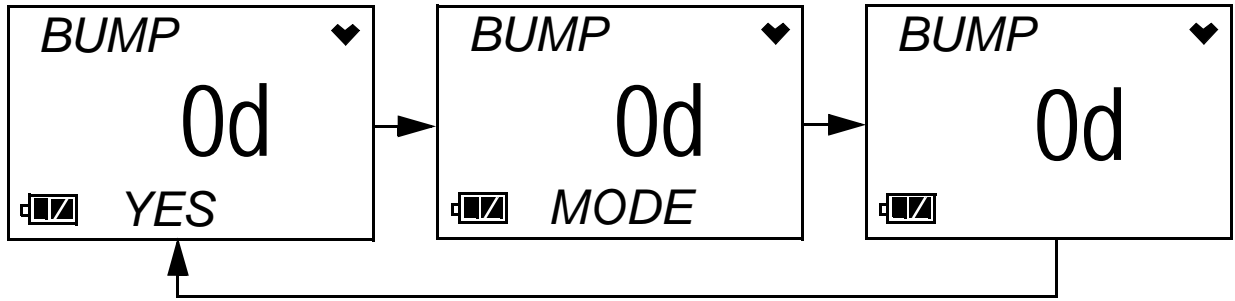

Press and release the POWER MODE button during this time to go to the BUMP menu item in Calibration Mode. If no button is pressed, the instrument will continue with the warmup sequence in Step 8 once the sequence shown above has finished.

NOTE: If a successful calibration is performed, the next bump test date is reset and starts over even though a bump test was not performed.

- If bump testing is not due, then the following screen appears for a few seconds indicating when the next bump test is due. “NEXT” and “BUMP” alternate on the bottom of the screen.

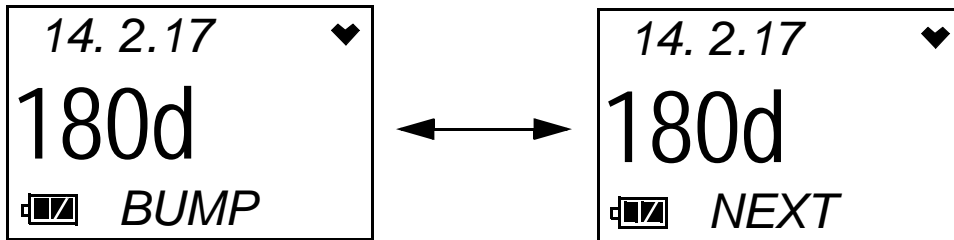

8. The Date/Time Screen appears for a few seconds.

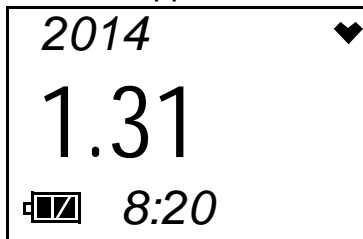

This screen displays the current date and time.

9. The Battery Voltage Screen appears for a few seconds.

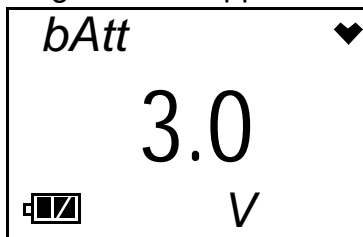

The screen displays the current battery voltage.

CAUTION: *If the unit gives a low battery warning or dead battery alarm, change the batteries before using the unit.*

10. The display then indicates the following items for about a second each:

- Full scale value
- Warning setpoint (low gas alarm)
- Alarm setpoint (high gas alarm)

11. If the GP-03 experiences a sensor failure during start up, the following screen will appear.



The instrument cannot be used if a sensor failure occurs. Replace the failed sensor.

12. If **Auto Zero Adjustment** is set to *On* (factory setting is *Off*), then the GP-03 will perform an automatic fresh air adjustment.

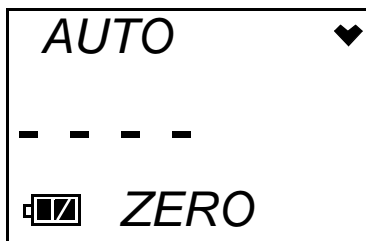

If the fresh air adjustment is successful, the unit will proceed to Normal Mode. If the sensor fails the air adjustment, the screen will indicate the failure. If a failure occurs, press and release the POWER MODE button to proceed to Normal Mode. Replace the failed sensor as soon as possible.

WARNING: *If the Auto Zero Adjustment feature is turned on, make sure that you start-up the GP-03 in a known fresh air environment, an environment free of combustible or toxic gasses and of normal oxygen content, 20.9%. If you do not start-up the unit in a fresh air environment, the fresh air adjustment will not be accurate.*

13. The GP-03 is now operating in Measuring Mode and monitoring for gas. The Normal Operation Screen appears and the instrument beeps once.

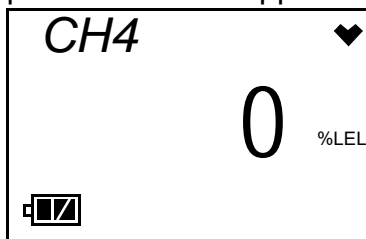

The gas concentration of the target gas is displayed along with the battery charge level in the lower left corner. The heart symbol displayed in the upper right corner flashes while the instrument is functioning properly. If it disappears or is steadily on, the unit is experiencing a microprocessor error. The backlight turns off after 20 seconds.

Performing a Fresh Air Adjustment

Before using the GP-03, set the fresh air reading. Performing this adjustment ensures accurate gas readings in the monitoring environment.

1. Find a fresh air environment of normal oxygen content (20.9%) that is free of toxic or combustible gases.
2. With the unit on and in Measuring Mode, press and hold the AIR button. The LCD displays "hold" prompting you to hold the AIR button.

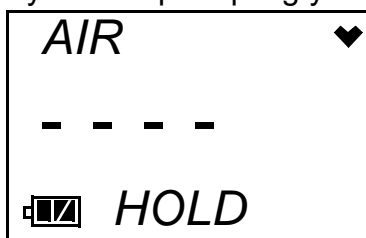

3. Release the AIR button when the following screen appears. The unit will set the reading to 0% LEL and return to Measuring Mode.

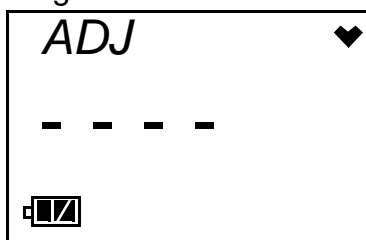

Turning Off the GP-03

1. Press and hold the POWER MODE button for about five seconds to turn off the unit. The buzzer will pulse while the POWER MODE button is being pressed before the unit turns off.
2. Release the button when the LCD is blank. The unit is off.

NOTE: If **Power Off Password Protection** is turned *On* (factory setting is *Off*) using the 03 Series User Setup Program, a password is required to turn the GP-03 off. When the password screen appears, adjust each digit with the AIR button and press and release the POWER MODE button to move on to the next digit. Once the password has been entered, the instrument will shut off and the LCD will be blank.

Operation

This section describes Measuring Mode, setting the buzzer volume, Display Mode, and alarm indications.

Measuring Mode

In Measuring Mode, the battery level and target gas concentration are displayed on the LCD. The battery icon has three bars visible when the batteries have a full charge. As the battery charge decreases, the bars will gradually disappear, one by one. The heart symbol displayed in the upper right corner flashes while the instrument is functioning properly. If it disappears or is steadily on, the unit is experiencing a microprocessor error.

The target gas concentration is displayed in the middle of the LCD in %LEL.

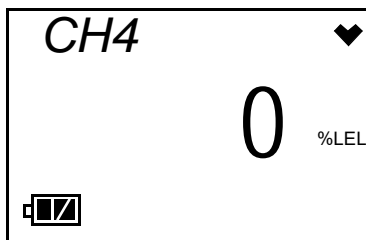

Combustible Gas Detection

There are three issues that must be considered when checking for combustible gas.

- The combustible gas sensor will respond to any combustible gas. The standard calibration for the GP-03 is to methane (CH₄). If the instrument is to be used to monitor for a different combustible gas, such

as hexane or propane, it should be calibrated to that gas.

The table below lists the conversion factors for several hydrocarbon gasses **if the GP-03 is calibrated to methane**. To use this table, multiply the display reading on the GP-03 by the factor in the appropriate row to obtain the actual gas concentration. For example, if you are detecting pentane and the display reads 10% LEL, you actually have $10\% \text{ LEL} \times 1.56 = 15.6\% \text{ LEL}$ pentane present.

Table 3: LEL Hydrocarbon Conversions

Gas	LEL Conversion Factor (Methane Calibration)	Gas	LEL Conversion Factor (Methane Calibration)
Acetone	1.79	Iso Butane	1.47
Acetylene	1.92	MEK	2.27
Benzene	2.00	Methane	1.00
Ethane	1.09	Methanol	1.92
Ethanol	2.50	Pentane	1.56
Ethylene	1.06	Propane	1.35
Heptane	2.50	Propylene	1.32
Hexane	2.08	Toluene	3.13
Hydrogen	1.25	Xylene	4.27
IPA	2.78		

- The GP-03 provides the combustible sensor with some protection against exposure to high levels of combustible gas. It does this by turning off the sensor power temporarily when it determines that an over scale (more than 100% LEL) concentration of combustible gas is present that may damage the sensor. Nevertheless, concentrations of combustible gas of more than 100% LEL can still affect the zero level or calibration of the combustible sensor if the concentration is high enough.

CAUTION: Do not expose the combustible sensor to high concentrations of combustible gas such as that from a butane lighter. Exposure to high concentrations of combustible gas may adversely affect the performance of the sensor.

- The H₂S scrubber disk is not normally installed in the GP-03 as shipped

from the factory. If H₂S is present in the monitoring area, the H₂S scrubber disk should be installed to protect the sensor from H₂S exposure. However, if the H₂S scrubber disk is used, then response to solvent gases such as IPA, toluene, or styrene will be slowed and decreased. If the GP-03 is to be used for solvent gas applications, do not install the H₂S scrubber disk.

Adjusting the Buzzer Volume

The buzzer volume on the GP-03 can be adjusted while in Measuring Mode if **Buzzer Volume Selection** is set to *On* (factory setting is *Off*). The **Buzzer Volume Selection** setting can be adjusted using the 03 Series User Setup Program. The default buzzer volume setting is HI. If it is changed to LO, the setting will revert back to HI the next time the instrument is turned on.

1. Make sure the GP-03 is in the Measuring Mode Normal Operation screen.
2. Press and hold the POWER MODE and AIR buttons simultaneously.

NOTE: To avoid entering Display Mode, press the AIR button slightly sooner than pressing the POWER MODE button.

Release both buttons when the instrument starts simulating an alarm condition after the second beep. The current setting for the buzzer will be displayed and the current volume will be emanating from the buzzer.



3. Use the AIR button to select LO or HI. The buzzer volume during the simulated alarm condition will change as you select a different volume.
4. Press and release the POWER MODE button to save the setting and return to Normal Operation.
5. If LO was selected, "B--LO" will appear at the bottom of the Normal Operation screen.

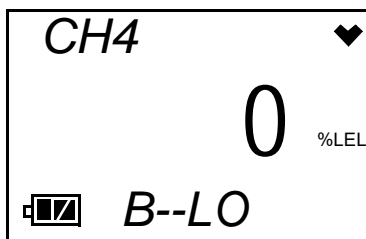

Display Mode

You can access Display Mode while in Measuring Mode by using the POWER MODE button. In Display Mode you can view and reset the peak reading, view the detection range full scale, and view the date and time.

To enter Display Mode, do the following:

1. Make sure the GP-03 is in the Measuring Mode Normal Operation screen. The GP-03 must be in the Normal Operation Screen for you to access Display Mode.
2. Press and release the POWER MODE button to enter Display Mode. The backlight will turn on and the PEAK Screen will appear.

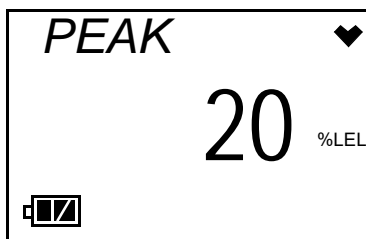

The peak reading since the GP-03 was turned on is displayed.

3. If you do not want to clear the peak reading, continue to the next step.

If you want to clear the peak reading, press and hold the AIR button. After a couple of seconds, the LCD will prompt you to hold the AIR button with the following screen.

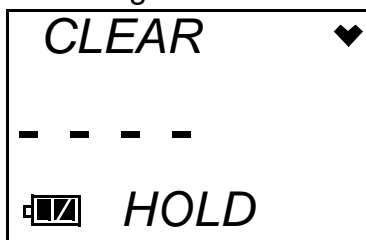

Hold the AIR button until the following screen appears, then release it.

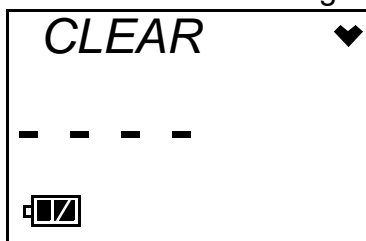

The peak reading will be cleared and the unit will return to the PEAK Screen.

4. Press and release the POWER MODE button again to proceed to the Full Scale Screen. The detection range full scale value is displayed. An "L" or an "A" will appear under the full scale value to indicate whether the alarms are set to latching (L) or auto-resetting (A). This setting can

be adjusted using the 03 Series User Setup Program.

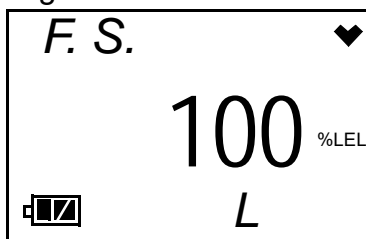

5. Press and release the POWER MODE button again to proceed to the Date/Time Screen. The date and time of the instrument is displayed.

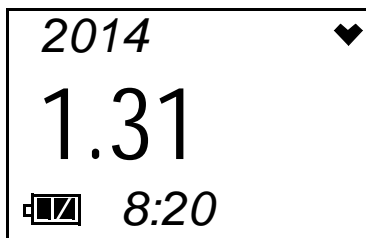

6. Press and release the POWER MODE button once again to return the unit to Measuring Mode.

NOTE: If you do not press a button for 20 seconds while in Display Mode, the unit will return to Measuring Mode automatically and the backlight will turn off.

Alarms

This section covers alarm indications. It also tells you how to reset the GP-03 after an alarm has occurred and how to respond to an alarm condition.

Alarm Indications

The GP-03 will sound the buzzer, flash its alarm light, and vibrate when the target gas concentration rises above the warning level. The GP-03 also sounds the buzzer, flashes its alarm light, and vibrates when the high level is reached. In addition, the GP-03 has a low battery warning, a dead battery alarm, an over range alarm, a sensor failure alarm, a system failure alarm, and a clock failure alarm. See Table 3 below for a description of each alarm indication.

Table 4: Alarm Types and Indications

Alarm Type	LCD Indications	Other Indications
<p>Warning Concentration of gas rises above the warning level.</p>	<ul style="list-style-type: none"> Gas reading flashes. WARN appears below the gas reading. Back light turns on. Alarm LED flashes. 	<ul style="list-style-type: none"> Buzzer sounds alternating between a low and high pitch. Vibrator pulses.
<p>Alarm Concentration of gas rises above the alarm level.</p>	<ul style="list-style-type: none"> Gas reading flashes. ALRM appears below the gas reading. Back light turns on. Alarm LED flashes faster than warning indication. 	<ul style="list-style-type: none"> Buzzer sounds alternating between low and high pitch faster than warning indication. Vibrator pulses faster than warning indication.
<p>Over Range Concentration of gas rises above the measuring limit of the GP-03. (Or there could be a problem with the unit.)</p>	<ul style="list-style-type: none"> Gas reading replaced by blinking brackets. □□□□ Back light turns on. ALRM appears below gas reading. 	<ul style="list-style-type: none"> Buzzer sounds alternating between low and high pitch at the same rate as alarm indication. Vibrator pulses at same rate as alarm indication.
<p>Low Battery Warning</p>	<ul style="list-style-type: none"> Last remaining bar on the right in battery icon flashes. 	<ul style="list-style-type: none"> None
<p>Dead Battery Alarm</p>	<ul style="list-style-type: none"> Gas reading replaced by FAIL. Battery icon flashes. 	<ul style="list-style-type: none"> Double pulsing tone (two pulses in quick succession) occurs once a second.
<p>Sensor Failure</p>	<ul style="list-style-type: none"> Gas name replaced by SENSOR. Gas reading replaced by FAIL. Alarm LED flashes. 	<ul style="list-style-type: none"> Double pulsing tone (two pulses in quick succession) once a second.

Table 4: Alarm Types and Indications

Alarm Type	LCD Indications	Other Indications
System Failure	<ul style="list-style-type: none"> • Gas name replaced by SYSTEM. • Gas reading replaced by FAIL. • Failure code displays below FAIL. 	<ul style="list-style-type: none"> • Double pulsing tone (two pulses in quick succession) once a second.
Clock Failure	<ul style="list-style-type: none"> • Gas name replaced by CLOCK. • Gas reading replaced by FAIL. 	<ul style="list-style-type: none"> • Double pulsing tone (two pulses in quick succession) once a second.

Resetting Gas Alarms

If the alarms are latching (factory setting), then an alarm indication will continue even if the gas reading causing the alarm decreases below the alarm setpoint and will continue until the alarm is reset. The gas reading that caused the alarm must decrease below the alarm setpoint before that alarm can be reset. To reset latching alarms, press and release the POWER MODE button after the gas reading falls below the alarm setpoint.

If the alarms are self-resetting, then an alarm condition will automatically reset when the gas reading that caused the alarm decreases below the alarm setpoint.

Responding to Alarms

This section describes response to gas, over range, battery, sensor failure, and system failure alarms.

Responding to Gas Alarms

1. Follow your established procedure for an increasing combustible gas condition.
2. If your unit is set for latching alarms, reset the alarm using the POWER MODE button once the alarm condition has been cleared.

Responding to an Over Range Alarm

WARNING: *An over range condition may indicate an extreme combustible gas concentration. Confirm the gas concentration with a different GP-03 or with another gas detecting device.*

CAUTION: *High off-scale readings may indicate an explosive concentration.*

PRUDENCE: *Des lectures élevées hors échelle peuvent indiquer une concentration explosive.*

1. Follow your established procedure for an increasing combustible gas condition.
2. Reset the alarm by pressing and releasing the POWER MODE button after the alarm condition has cleared.
3. Calibrate the GP-03 as described in “Calibration Mode” on page 33.
4. If the over range condition continues, replace the sensor as described in “Replacing the Sensor” on page 67.
5. If the over range condition continues after you have replaced the sensor, contact RKI Instruments, Inc. for further instructions.

Responding to Battery Alarms

WARNING: *The GP-03 is not operational as a gas monitoring device during a dead battery alarm. Take the GP-03 to a non-hazardous area and change the batteries as described in “Replacing or Recharging the Batteries” on page 65.*

The GP-03 is fully functional in a low battery warning condition. However, only a limited amount of time remains for operation (approximately 30 minutes when using the Ni-MH batteries or 2 hours when using alkaline batteries). The amount of time depends on how often the LCD backlight is used and how often the unit is responding to alarm conditions.

NOTE: Alarms and the back light feature consume battery power and reduce the amount of operating time remaining.

When a low battery warning occurs, change the batteries as soon as possible. Refer to the instructions in “Replacing or Recharging the Batteries” on page 65 for more information.

Responding to a Sensor Failure Alarm

1. Try calibrating the GP-03 as described in “Calibration Mode” on page 33.
2. If the sensor failure continues, replace the sensor as described in “Replacing the Sensor” on page 67.
3. If the gas sensor failure condition continues after you have replaced the gas sensor, contact RKI Instruments, Inc. for further instructions.

Responding to a System Failure Alarm

1. If a system failure occurs, the system failure screen will display an error code as shown below:

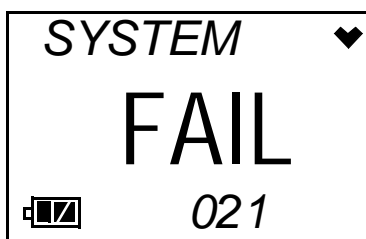

2. The error code meanings are shown below:

Table 5: Error Code Explanation

Error Code	Explanation
000	MPU failure
010	RAM failure
021	EEPROM failure

3. The instrument cannot be used if a system failure occurs. Contact RKI Instruments, Inc. as soon as possible.

Responding to a Clock Failure Alarm

This alarm occurs if the internal unit date has been changed to something unreasonable like 15/34 (month/day).

1. Press and release the POWER MODE button to continue into normal operation.

CAUTION: *There will be no datalogging function if you operate the instrument after a clock failure.*

2. Attempt to change the date using the DATE menu item in Calibration Mode. See “Setting the Date and Time” on page 35.
3. If the date cannot be set correctly, contact RKI Instruments, Inc. as soon as possible.

Data Logging

The GP-03 features the ability to log data to its internal memory and download it to a computer via the IrDA port on the top of the front case. It logs normal operation gas readings, alarm data, calibration data, and bump test data.

To utilize the GP-03's downloading capability, you will need the 03 Series Data Logger Management Program and a computer with an infrared port that conforms to IrDA 1.1 protocol or a USB port that runs one of the following operating systems: Windows 7, Windows 8, or Windows 10. If your computer has an infrared port that conforms to IrDA 1.1 protocol, then no additional accessories are needed to download data from the GP-03. If your computer does not have an infrared port but does have a USB port, a USB/IrDA adapter cable can be used to download data from the GP-03 using the USB port. The 03 Series Data Logger Management Program is available at www.rkiinstruments.com/03series. The USB/IrDA adapter cable is also available from RKI.

See the 03 Series Data Logger Management Program Operator's Manual for a complete description of the 03 Series Data Logger Management Program and procedures for downloading data to a computer.

03 Series User Setup Program

There are some instrument operating parameters that are not accessible in either Calibration Mode or Setup Mode such as the calibration frequency, auto zero function, and the alarm logic (latching or self resetting). Many of these parameters either do not typically need to be accessed once the GP-03 is shipped from the factory or may only need to be accessed once because of operator preferences. These parameters can be accessed and updated if necessary using the 03 Series User Setup Program, a computer with the same requirements described above in "Data Logging", and a USB/IrDA cable if necessary. The 03 Series User Setup Program is available at www.rkiinstruments.com/03series. The USB/IrDA adapter cable is also available from RKI. See the 03 Series User Setup Program Operator's Manual for a complete description of the 03 Series User Setup Program and procedures for accessing and updating instrument operating parameters.

Calibration Mode

This section describes the GP-03 in Calibration Mode. In Calibration Mode, you can move through a menu of screens to do the following:

- Set the date and time
- Perform a fresh air adjustment (part of a calibration)
- Perform an automatic span adjustment (part of a calibration)
- Perform a manual span adjustment (part of a calibration)
- Perform a bump test (if **Bump Test Function** is set to *On* using the 03 Series User Setup Program)
- View the instrument's firmware version and firmware checksum

NOTE: You can set the GP-03 to alert you during the startup sequence when calibration or bump testing is due with the 03 Series User Setup Program. See the 03 Series User Setup Program Operator's Manual for information on setting the **Cal. Limit Display** and **Bump Test Limit Display** parameters.

Calibration Frequency

The optimum frequency of calibration depends heavily on how the GP-03 is used. For example, instruments used daily may need to be calibrated weekly or monthly, while instruments that are used only a few times a year may need to be calibrated before each use. Typical calibration frequencies range from monthly to quarterly. Make sure to develop a calibration schedule tailored to your application.

Using Calibration Mode

WARNING: *The GP-03 is not in operation as a gas detector while in Calibration Mode. Although it will respond to gas in parts of AIR CAL, A--CAL., M--CAL., and BUMP, there are no gas alarm indications.*

1. Take the GP-03 to a non-hazardous area and turn it off if it is on.

2. Press and hold the AIR button, then press and hold the POWER MODE button. When you hear a beep release the buttons. The DATE Screen is displayed.

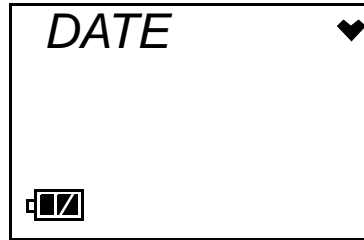

3. Use the AIR button to move forward through Calibration Mode. When you get to the last menu item, the START menu item, continuing will take you back to the beginning of the menu.
4. When you arrive at the item you wish to enter, press and release the POWER MODE button to enter that item.
5. When you need to adjust the numerical value of a parameter, increase it or decrease it, use the AIR button to change the value. When adjusting a numerical parameter value, it is possible to reverse the direction of adjustment. To switch from increasing to decreasing a value or decreasing to increasing a value, do the following:
 - with the parameter flashing on the screen, press and hold the AIR button
 - immediately press the POWER MODE button and then release both buttons
 - the direction of adjustment when you press the AIR button is now reversed
6. When you are done using the menu items in Calibration Mode, use the AIR button to scroll through the menu items to the START item.

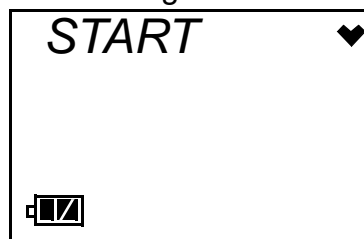

7. At the START screen, press and release the POWER MODE button. The GP-03 will begin its start-up sequence.

The Calibration Mode menu items are described below in the order in which they appear while moving through Calibration Mode.

Setting the Date and Time

Entering the DATE menu item allows you to set the date and time.

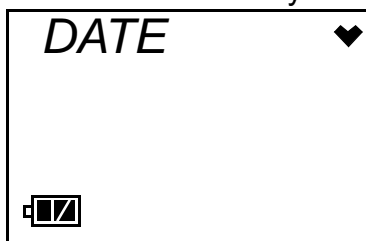

1. When the DATE Screen is displayed, press and release the POWER MODE button. A screen appears with the year flashing in the upper left, the month and day in the middle, and the time in the lower right.

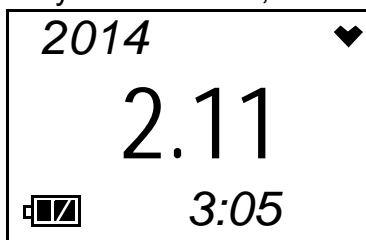

2. Use the AIR button to display the desired year.
3. Press and release the POWER MODE button to save the setting. The month setting flashes.
4. Repeat steps 2 and 3 to enter the month, day, hour and minute setting. When you save the minute setting, END is displayed before the instrument returns to the DATE Screen.

Performing a Fresh Air Adjustment

Entering the AIR menu item allows you to perform a fresh air adjustment.

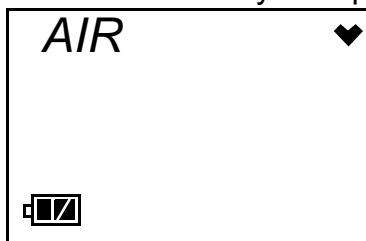

Perform a fresh air adjustment in Calibration Mode when you are performing a calibration before proceeding either to the A--CAL or M--CAL menu item to perform a span adjustment. A fresh air adjustment performed in Calibration Mode is the same as a fresh air adjustment in Normal Mode. The AIR menu item is available in Calibration Mode for convenience when performing a complete calibration.

WARNING: Calibrate the GP-03 in a non-hazardous environment.

1. Find a fresh air environment, an environment of normal oxygen content (20.9%) that is free of toxic and combustible gasses.
2. When the AIR screen is displayed, press and release the POWER MODE button. A screen appears that displays the current gas reading.

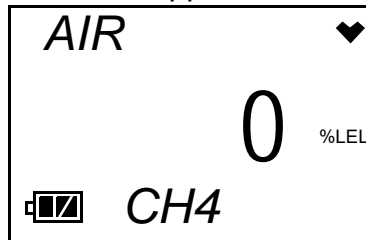

If you want to cancel the fresh air adjustment, press and release the AIR button to return to the AIR screen. To continue with the fresh air adjustment, proceed to Step 3.

3. Press and hold the AIR button. The LCD prompts you to continue to hold the AIR button.

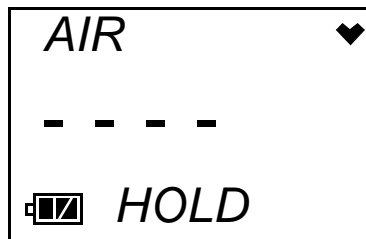

4. Release the AIR button when the following screen appears.

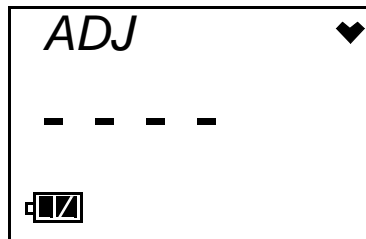

5. The unit will take a few seconds to adjust the fresh air reading, then indicate "END" in the upper left corner and return to the AIR Screen.

Performing an Automatic Span Adjustment in A--CAL

Entering the A--CAL menu item allows you to perform an automatic span adjustment.

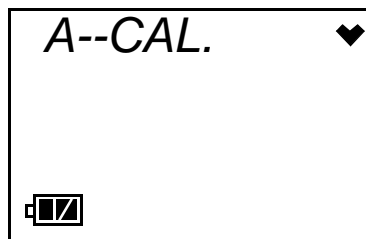

Perform a span adjustment as part of a calibration after performing a fresh

air adjustment. Performing a span adjustment requires the use of a calibration kit. A calibration kit is available from RKI Instruments, Inc. for the GP-03 (see “Parts List” on page 71). You will need:

- A gas cylinder with an appropriate concentration of the target gas

CAUTION: Do not use a gas mix that includes H_2S to calibrate the GP-03.

- a fixed-flow regulator with a flow rate of 0.5 LPM (liters per minute)

WARNING: Use a 0.5 LPM (liters per minute) fixed flow regulator when calibrating. Using a different flow rate may adversely affect the accuracy of the calibration.

- non-absorbent tubing
- calibration adapter that will fit over the GP-03’s sensor

WARNING: Calibrate the GP-03 in a non-hazardous environment.

1. Before performing a span adjustment, perform a fresh air adjustment as described in “Performing a Fresh Air Adjustment” on page 35.
2. At the A--CAL screen, press and release the POWER MODE button. A screen appears that displays the calibration gas concentration that the GP-03 expects you to use.

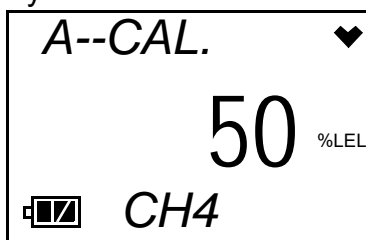

If the displayed concentration matches the calibration cylinder concentration, continue with Step 4.

If the displayed concentration does not match the calibration cylinder concentration, do the following:

- Press and hold the AIR button, then press and momentarily hold the POWER MODE button.

- Release both buttons as soon as you hear the buzzer sound a beep. The following screen will display and the gas concentration will be flashing.

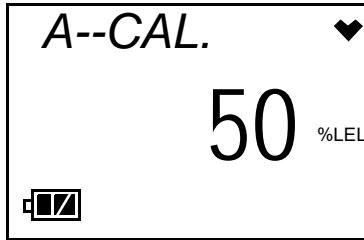

- Use the AIR button to adjust the calibration gas value to the desired value. See Step 5 on page 34 for instructions to increase or decrease the value.
- Press and release the POWER MODE button to accept the displayed value. The previous screen will return.

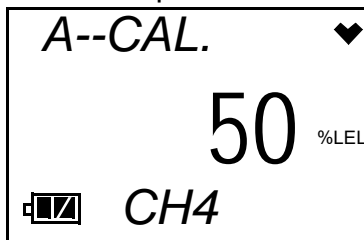

3. Press and release the POWER MODE button. The LCD will display the current gas readings and "A--CAL." will flash.

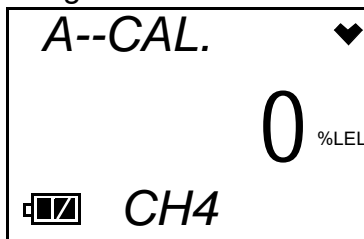

If you want to cancel the calibration, press and hold the AIR key for 2 seconds. The instrument will return to the A--CAL. Screen. If you hold the AIR key down longer than 2 seconds, the instrument will start scrolling through the Calibration Mode items.

4. Use the sample tubing to connect the calibration adapter to the regulator. Attach the tubing to the calibration adapter on the inlet side as shown below in Figure 5.

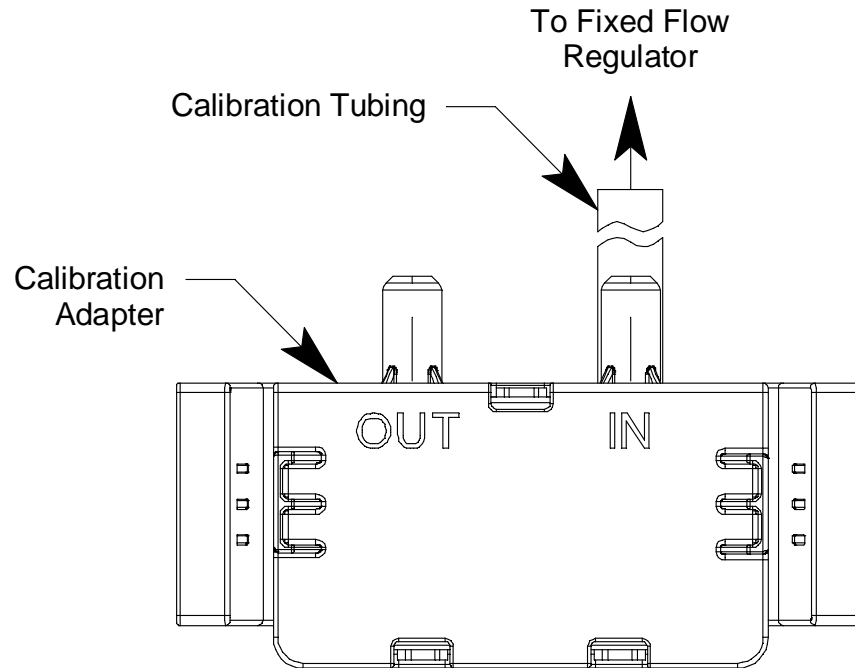

Figure 5: Calibration Kit Assembly

5. Confirm that the regulator on/off knob is turned all the way clockwise (closed) and screw the calibration gas cylinder onto the regulator.
6. Push the calibration adapter onto the GP-03's sensor face as shown in Figure 6. The calibration adapter secures itself to the instrument by latching on to two recesses in the instrument's rear case. The rubber boot (if installed) does not need to be removed to install the adapter.

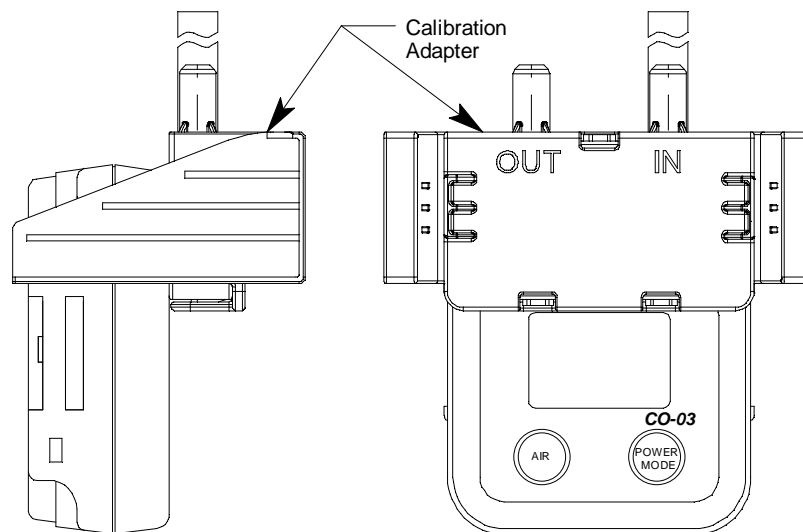
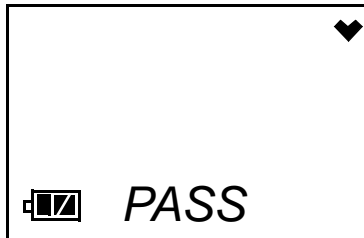
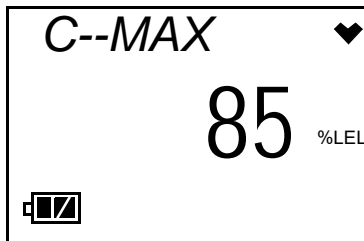

Figure 6: Installing the Calibration Adapter

7. Turn the regulator on/off knob counterclockwise to open it. Calibration gas will begin to flow.
8. Allow the gas to flow for two minutes.
9. Press and release the POWER MODE button.
10. The GP-03 will attempt to make a span adjustment.
11. If the span adjustment is successful, the LCD will show the following screen before returning to the A--CAL screen.



If the **Maximum Span** setting is turned *On* (factory setting is *Off*) using the 03 Series User Setup Program, the LCD will show the maximum reading the sensor could have been calibrated to before returning to the A--CAL screen.



12. If the span adjustment fails, the LCD will show the following screen, the alarm LED will flash, and the buzzer will sound a double pulsing tone.

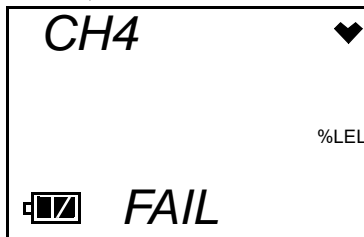

Press and release the POWER MODE button to clear the failure indication and return to the A--CAL. screen.

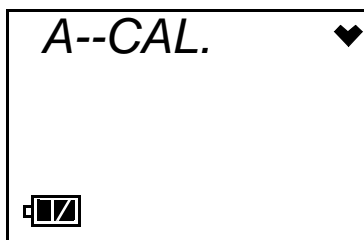

See "Troubleshooting" on page 63 to investigate the cause of the failure and replace the failed sensor if necessary.

13. Turn the regulator on/off knob clockwise to close it.
14. Remove the calibration adapter from the instrument.
15. Remove the regulator from the calibration gas cylinder.
16. Leave the regulator connected to the calibration adapter for convenience.
17. Store the components of the calibration kit in a safe and convenient place.

Performing an Easy Span Adjustment in E--CAL

The E--CAL menu item only appears in Calibration Mode if the **One Touch Cal Time** parameter in the 03 Series User Setup Program is set to anything other than 0 (factory setting). When **One Touch Cal Time** is set to 0, A--CAL will replace E--CAL. The value entered into the **One Touch Cal Time** field is the amount of time that the instrument will allow gas to be applied before attempting to perform a span adjustment.

Entering the E--CAL menu item allows you to perform an easy span adjustment. In an easy span adjustment, the instrument will automatically count down in the E--CAL gas exposure screen when gas is applied and perform a span adjustment when the countdown is over.

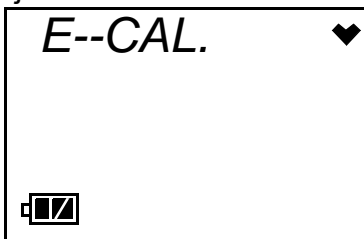

Perform a span adjustment as part of a calibration after performing a fresh air adjustment. Performing a span adjustment requires the use of a calibration kit. A calibration kit is available from RKI Instruments, Inc. (see “Parts List” on page 71). You will need:

- A gas cylinder with an appropriate concentration of the target gas

CAUTION: Do not use a gas mix that includes H_2S to calibrate the GP-03.

- a fixed-flow regulator with a flow rate of 0.5 LPM (liters per minute)

WARNING: Use a 0.5 LPM (liters per minute) fixed flow regulator when calibrating. Using a different flow rate may adversely affect the accuracy of the calibration.

- non-absorbent tubing
- calibration adapter that will fit over the GP-03's sensor

WARNING: Calibrate the GP-03 in a non-hazardous environment.

1. Before performing a span adjustment, perform a fresh air adjustment as described in “Performing a Fresh Air Adjustment” on page 35.
2. At the E--CAL screen, press and release the POWER MODE button. A screen appears that displays the calibration gas concentration that the GP-03 expects you to use.

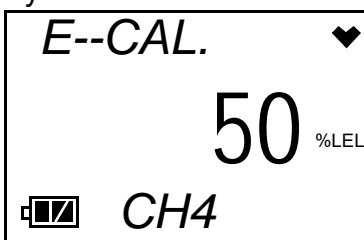

If the displayed concentration matches the calibration cylinder concentration, continue with Step 3.

If the displayed concentration does not match the calibration cylinder concentration, do the following:

- Press and hold the AIR button, then press and momentarily hold the POWER MODE button.
- Release both buttons as soon as you hear the buzzer sound a beep. The following screen will display and the gas concentration will be flashing.

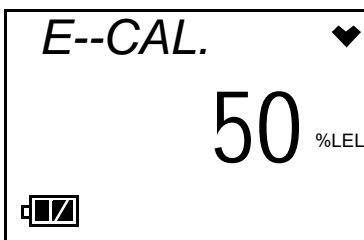

- Use the AIR button to adjust the calibration gas value to the desired value. See Step 5 on page 34 for instructions to increase or decrease the value.
- Press and release the POWER MODE button to accept the displayed value. The previous screen will return.

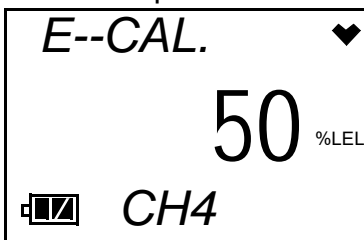

3. Press and release the POWER MODE button. The LCD will display the current gas readings and “E--CAL.” will flash.

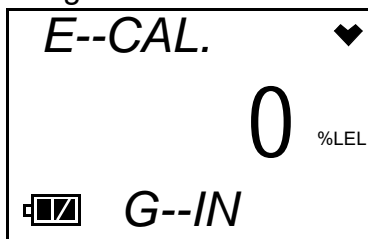

If you want to cancel the calibration, press and hold the AIR key for 2 seconds. The instrument will return to the E--CAL. Screen. If you hold the AIR key down longer than 2 seconds, the instrument will start scrolling through the Calibration Mode items.

4. Use the sample tubing to connect the calibration adapter to the regulator. Attach the tubing to the calibration adapter on the inlet side as shown below in Figure 7.

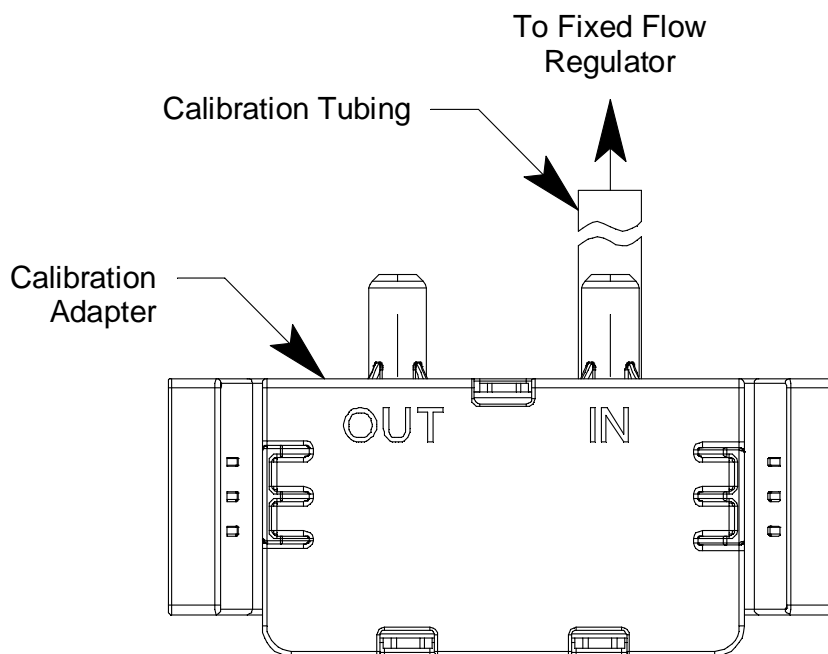

Figure 7: Calibration Kit Assembly

5. Confirm that the regulator on/off knob is turned all the way clockwise (closed) and screw the calibration gas cylinder onto the regulator.

6. Push the calibration adapter onto the GP-03's sensor face as shown in Figure 8. The calibration adapter secures itself to the instrument by latching on to two recesses in the instrument's rear case. The rubber boot (if installed) does not need to be removed to install the adapter.

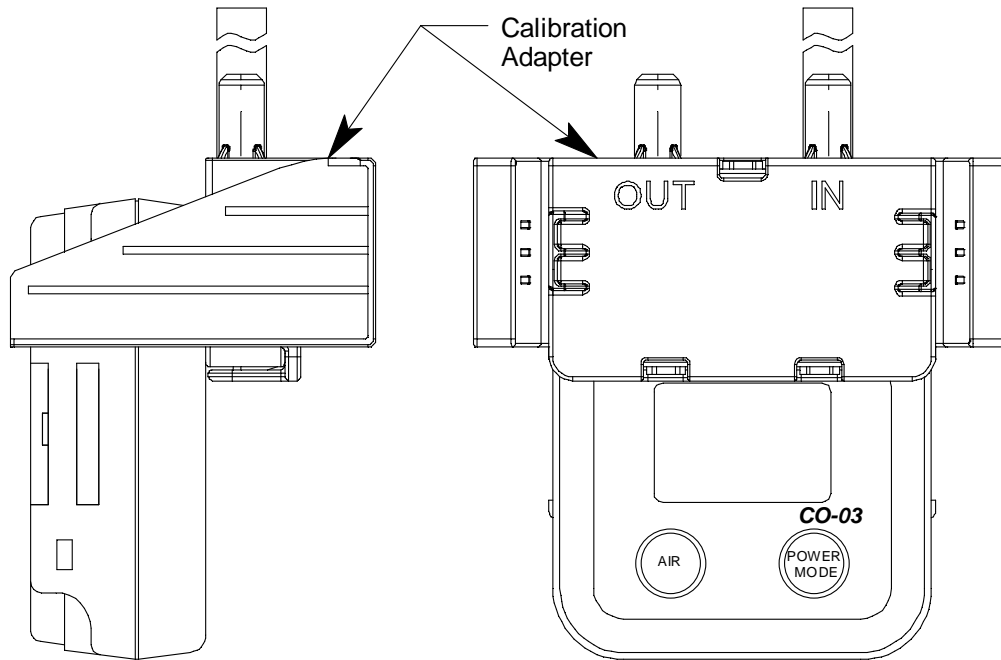
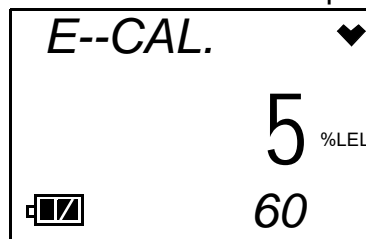

Figure 8: Installing the Calibration Adapter

7. Turn the regulator on/off knob counterclockwise to open it. Calibration gas will begin to flow.
8. Once the gas reading reaches 10% of the calibration gas value, "E--CAL" will begin to flash and a countdown will begin. The countdown's duration is defined by the value of the **One Touch Cal Time** parameter accessed in the 03 Series User Setup Program.



If the gas reading never reaches 10% of the calibration gas value, the countdown will never start and the instrument will remain in the G--IN screen shown in Step 3. Press and hold the AIR button for 2 seconds to cancel the calibration then continue with Step 12. See "Troubleshooting" on page 63 to investigate the cause of the issue.

9. At the end of the countdown, the GP-03 will attempt to make a span adjustment.

10. If the span adjustment is successful, the LCD will show the following screen before returning to the E--CAL screen.

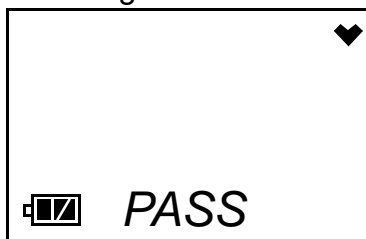

If the **Maximum Span** setting is turned *On* (factory setting is *Off*) using the 03 Series User Setup Program, the LCD will show the maximum reading the sensor could have been calibrated to before returning to the E--CAL screen.

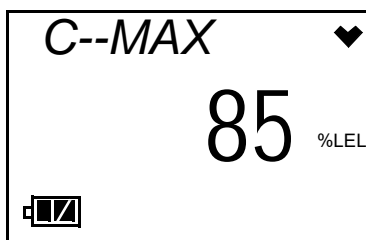

11. If the span adjustment fails, the LCD will show the following screen, the alarm LED will flash, and the buzzer will sound a double pulsing tone.

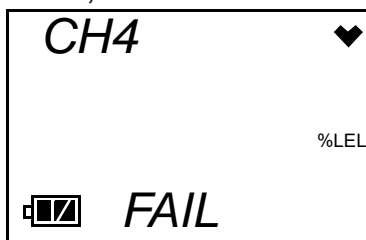

Press and release the POWER MODE button to clear the failure indication and return to the E--CAL. screen.

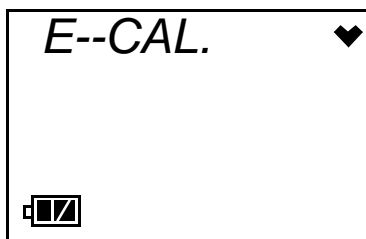

See "Troubleshooting" on page 63 to investigate the cause of the failure and replace the failed sensor if necessary.

12. Turn the regulator on/off knob clockwise to close it.
13. Remove the calibration adapter from the instrument.
14. Remove the regulator from the calibration gas cylinder.
15. Leave the regulator connected to the calibration adapter for convenience.

16. Store the components of the calibration kit in a safe and convenient place.

Performing a Manual Span Adjustment in M--CAL

Entering the M--CAL menu item allows you to perform a manual span adjustment.

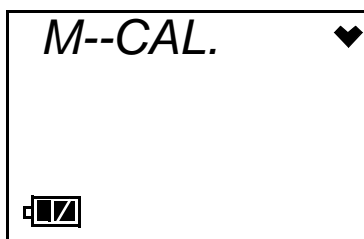

Perform a span adjustment as part of a calibration after performing a fresh air adjustment. Performing a span adjustment requires the use of a calibration kit. A calibration kit is available from RKI Instruments, Inc. for the GP-03 (see “Parts List” on page 71). The procedure below describes a span adjustment. You will need:

- A gas cylinder with an appropriate concentration of the target gas

CAUTION: Do not use a gas mix that includes H_2S to calibrate the GP-03.

- a fixed-flow regulator with a flow rate of 0.5 LPM (liters per minute)

WARNING: Use a 0.5 LPM (liters per minute) fixed flow regulator when calibrating. Using a different flow rate may adversely affect the accuracy of the calibration.

- non-absorbent tubing
- calibration adapter that will fit over the GP-03's sensor

WARNING: Calibrate the GP-03 in a non-hazardous environment.

1. Before performing a span adjustment, perform a fresh air adjustment as described in “Performing a Fresh Air Adjustment” on page 35.

- At the M--CAL screen, press and release the POWER MODE button. The current gas reading will be shown and it will be flashing. The arrows shown at the bottom of the screen indicate the direction of adjustment for the AIR button.

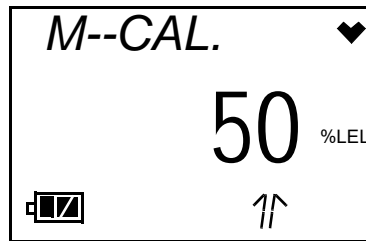

- Use the sample tubing to connect the calibration adapter to the regulator. Attach the tubing to the calibration adapter on the inlet side as shown below in Figure 9.

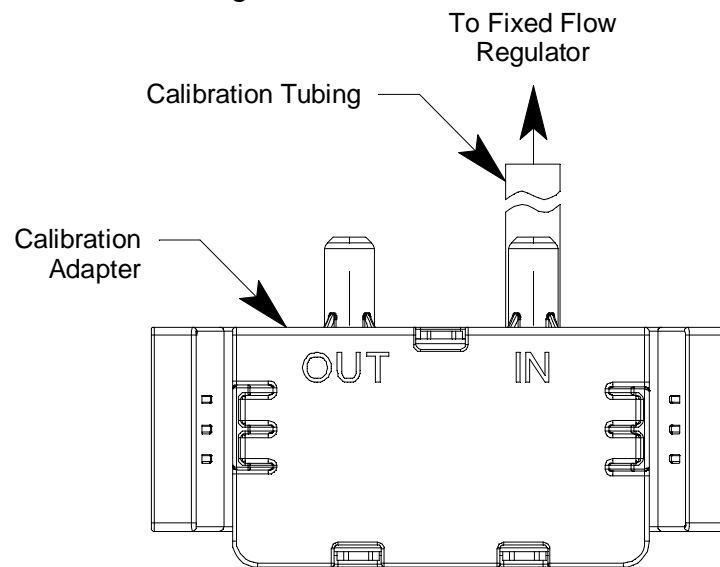

Figure 9: Calibration Kit Assembly

- Confirm that the regulator on/off knob is turned all the way clockwise (closed) and screw the calibration gas cylinder onto the regulator.

5. Push the calibration adapter onto the GP-03's sensor face as shown in Figure 10. The calibration adapter secures itself to the instrument by latching on to two recesses in the instrument's rear case. The rubber boot (if installed) does not need to be removed to install the adapter.

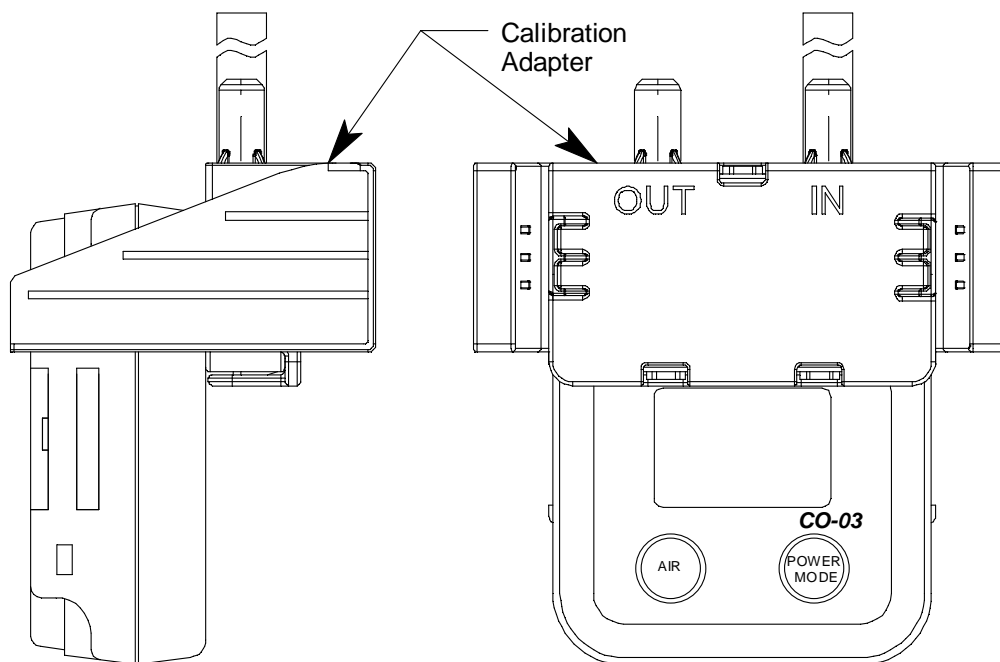
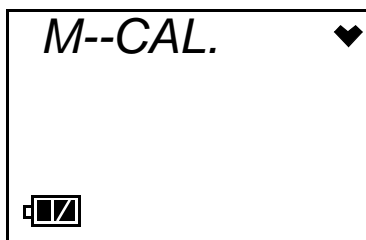

Figure 10: Installing the Calibration Adapter

6. Turn the regulator on/off knob counterclockwise to open it. Calibration gas will begin to flow.
7. Allow the gas to flow for two minutes.
8. Adjust the display gas reading using the AIR button to match the calibration cylinder's target gas concentration. See Step 5 on page 34 for instructions to adjust a parameter using the AIR button. If the direction of adjustment is changed, the arrows at the bottom of the screen will change direction.
9. Press and release the POWER MODE button.
10. The GP-03 will make the span adjustment and will return to the M--CAL. Screen.



11. Turn the regulator on/off knob clockwise to close it.

12. Remove the calibration adapter from the instrument.
13. Remove the regulator from the calibration gas cylinder.
14. Leave the regulator connected to the calibration adapter for convenience.
15. Store the components of the calibration kit in a safe and convenient place.

Performing a Bump Test in BUMP

NOTE: **Bump Test Function** must be set to *On* using the 03 Series User Setup Program in order for BUMP to appear in Calibration Mode. If **Bump Test Function** is set to *Off*, BUMP will not appear. See the 03 Series User Setup Program Operator's Manual for instructions. The factory setting for **Bump Test Function** is *Off*.

Entering the BUMP menu item allows you to perform a bump test to determine if the instrument is responding properly to gas.

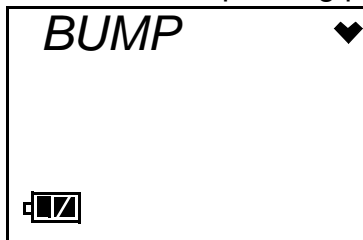

Performing a bump test requires the use of a calibration kit. A calibration kit is available from RKI Instruments, Inc. for the GP-03 (see "Parts List"). You will need:

- A gas cylinder with an appropriate concentration of the target gas

CAUTION: *Do not use a gas mix that includes H₂S to bump test the GP-03.*

- a fixed-flow regulator with a flow rate of 0.5 LPM (liters per minute)

WARNING: *Use a 0.5 LPM (liters per minute) fixed flow regulator when bump testing. Using a different flow rate may adversely affect the accuracy of the bump test.*

- non-absorbent tubing
- calibration adapter that will fit over the GP-03's sensor

WARNING: *Bump test the GP-03 in a non-hazardous environment.*

1. Before performing a bump test, perform a fresh air adjustment as described in “Performing a Fresh Air Adjustment” on page 35.
2. At the BUMP screen, press and release the POWER MODE button. A screen appears that displays the gas concentration that the GP-03 expects you to use.

NOTE: The bump test gas concentration is the same as the A--CAL gas concentration.

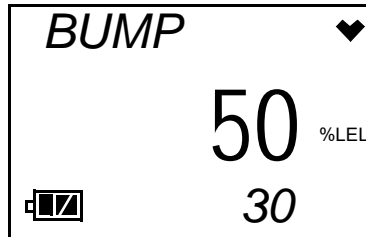

If the value is not correct, you can change it by changing the A--CAL gas value in Calibration Mode or Setup Mode or by using the 03 Series Data Logger Management Program or the 03 Series User Setup Program.

3. Use the sample tubing to connect the calibration adapter to the regulator. Attach the tubing to the calibration adapter on the inlet side as shown below in Figure 11.

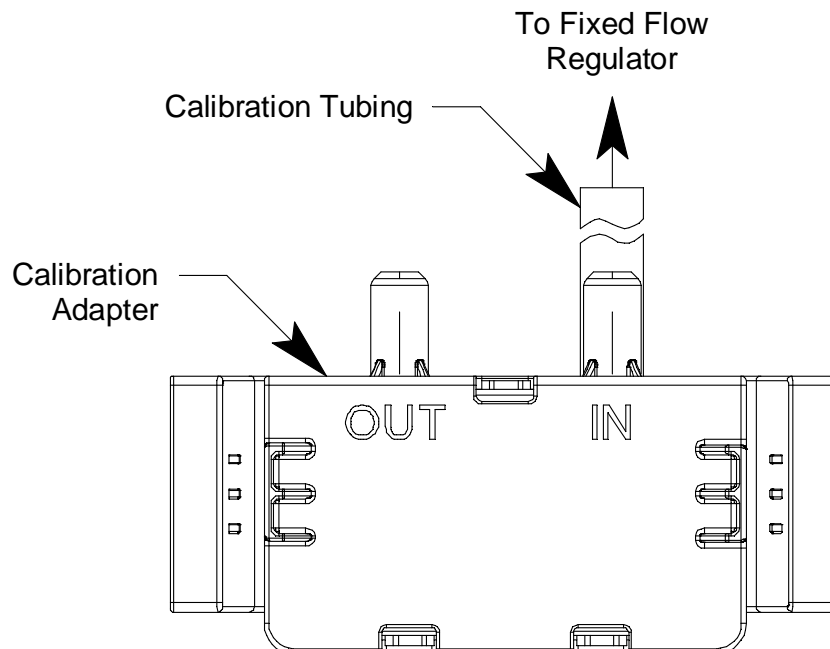

Figure 11: Calibration Kit Assembly

4. Confirm that the regulator on/off knob is turned all the way clockwise (closed) and screw the calibration gas cylinder onto the regulator.

5. Push the calibration adapter onto the GP-03's sensor face as shown in Figure 12. The calibration adapter secures itself to the instrument by latching on to two recesses in the instrument's rear case. The rubber boot (if installed) does not need to be removed to install the adapter.

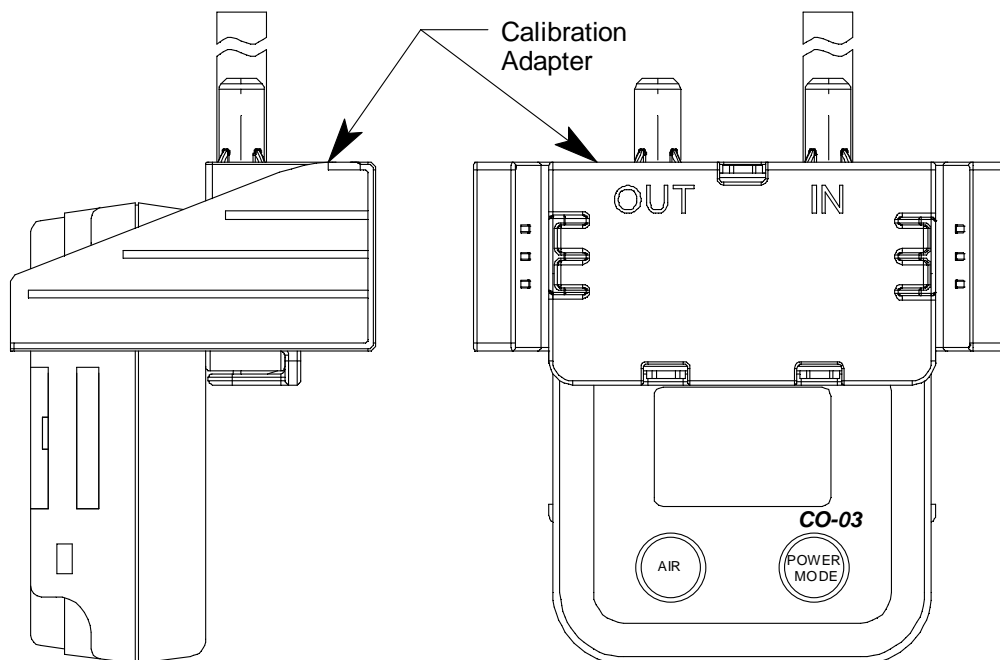
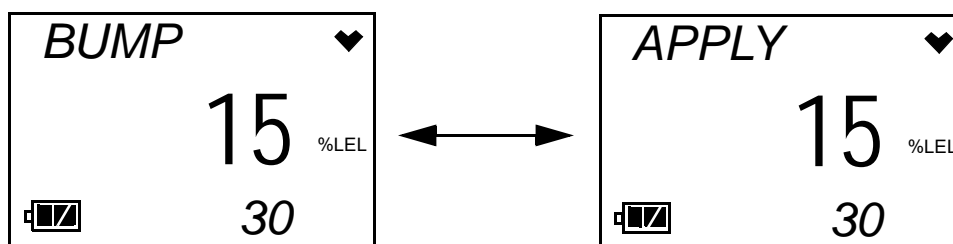

Figure 12: Installing the Calibration Adapter

6. Press and release the POWER MODE button. The LCD will display the current gas reading, "BUMP" and "APPLY" will alternate at the top of the screen, and the instrument will begin a count down whose length depends on how the **Bump Test Time(sec)** parameter in the 03 Series User Setup Program is set. The factory setting is 30 seconds.



7. Turn the regulator on/off knob counterclockwise to open it. Calibration gas will begin to flow. Do not delay opening the regulator.
8. When the bump test countdown reaches 0, the unit will determine the bump test results and proceed as described in either Step 9 or Step 10 depending on the setting of **Calibration After Bump Test Failed**. See the 03 Series User Setup Program Operator's Manual for a complete description of this parameter.

9. When **Calibration After Bump Test Failed** is set to Off:

- The instrument will display a “P” for pass or an “F” for fail.

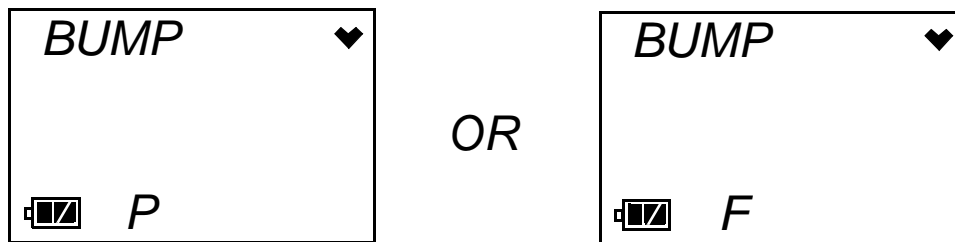

- To view the bump test gas reading, press the AIR button.

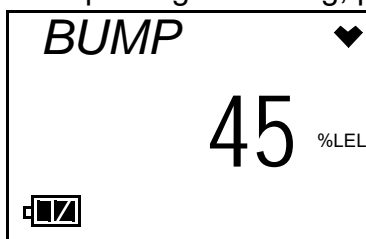

- To return to the BUMP screen in Calibration Mode, press POWER MODE at any time.

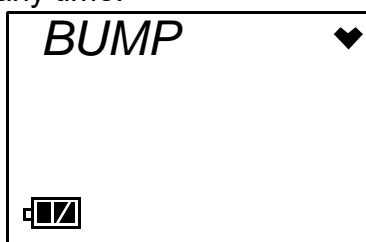

See “Troubleshooting” on page 63 to investigate the cause of the failure and replace the failed sensor if necessary.

- Turn the regulator on/off knob clockwise to close it.

10. When **Calibration After Bump Test Failed** is set to On:

If the instrument passes the bump test,

- The following screen appears:

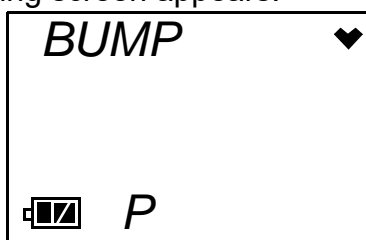

- To view the bump test gas reading, press the AIR button.

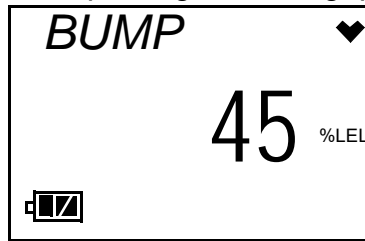

- To return to the BUMP screen in Calibration Mode, press POWER MODE at any time.

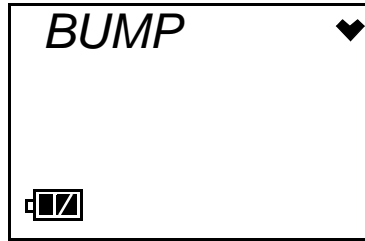

If the instrument fails the bump test,

- A calibration is immediately and automatically started. The instrument will begin a countdown whose length depends on the **Bump Test Time(sec)** and **Calibration Time(sec) After Bump Test Failed** parameters' values. These parameters can be changed using the 03 Series User Setup Program. The countdown time for the calibration is the **Calibration Time(sec) After Bump Test Failed** value (factory setting is 90 seconds) minus the **Bump Test Time(sec)** value (factory setting is 30 seconds). Continue to apply the calibration gas.

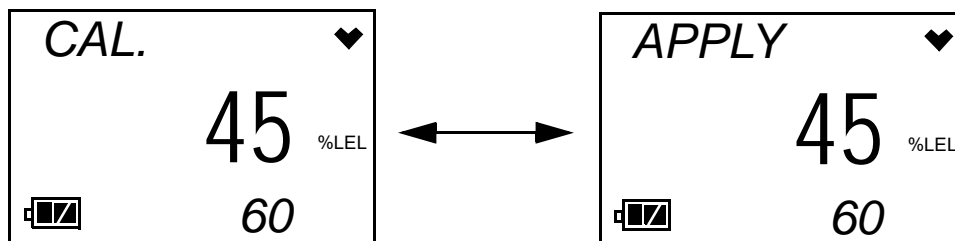

- At the end of the calibration, the instrument displays the results from both the bump test and the calibration. The bump test's result is the first letter and the calibration's result is the second letter. An "F" represents a failed test and a "P" represents a passed test.

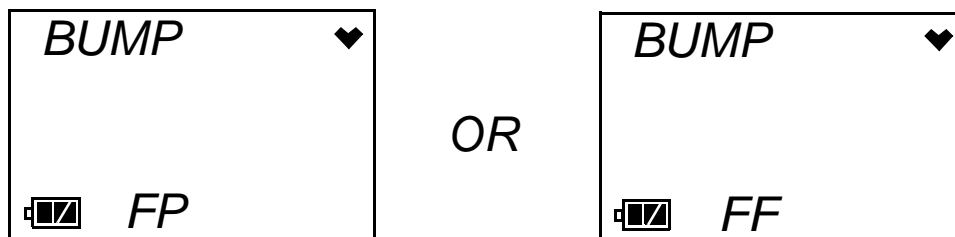

- To view the bump test gas readings, press the AIR button.

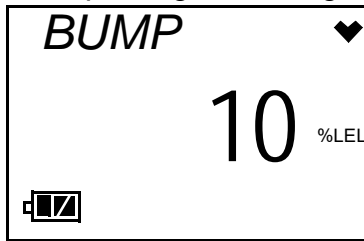

- To view the calibration gas reading, press the AIR button again.

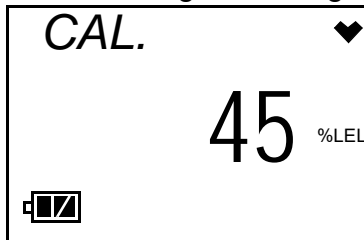

- To return to the BUMP screen in Calibration Mode, press POWER MODE at any time.

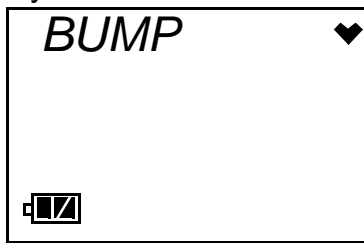

- Turn the regulator on/off knob clockwise to close it.

11. Remove the calibration adapter from the instrument.
12. Remove the regulator from the calibration gas cylinder.
13. Leave the regulator connected to the calibration adapter for convenience.
14. Store the components of the calibration kit in a safe and convenient place.

Viewing the Instrument's Firmware Version

The ROM screen shows the firmware version that is loaded in the instrument and the firmware checksum.

1. At the ROM screen, press and release the POWER MODE button.

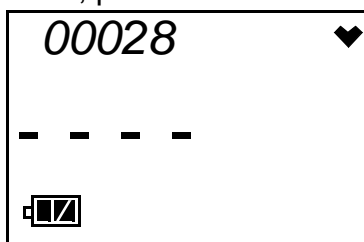

2. After a few seconds, the following screen will be displayed. The top line is the firmware version (00028 in this example) and the bottom line is the firmware checksum (FE7F in this example).



3. Press and release the POWER MODE button to return to the ROM screen.

Setup Mode

This section describes the GP-03 in Setup Mode. Setup Mode has the same menu items as Calibration Mode with the addition of the ALM--P menu item which allows you to set the alarm points, the BP--EXP. menu item which allows you to select how the instrument's warmup will proceed when a bump test is due, and the PASS--W menu item which allows you to turn the password feature on or off and set the password. The common menu items are included in Setup Mode as a convenience to avoid turning off the unit and entering Calibration Mode if you are updating alarm points and also want to use one of the other menu items. In Setup Mode, you can move through a menu of screens to do the following:

- Set the date and time (same as in Calibration Mode)
- Perform a fresh air adjustment (same as in Calibration Mode)
- Perform an automatic span adjustment (same as in Calibration Mode)
- Perform a manual span adjustment (same as in Calibration Mode)
- Set the alarm points
- Set the Bump Test Limit Check setting
- Turn the password feature on or off and define the password

NOTE: You can set the GP-03 to alert you during the startup sequence when calibration or bump testing is due with the 03 Series User Setup Program. See the 03 Series User Setup Program Operator's Manual for information on setting the **Cal. Limit Display** and **Bump Test Limit Display** parameter.

The description of the menu items that are common to Calibration Mode and Setup Mode will refer you to the appropriate pages in the Calibration Mode section.

Using Setup Mode

WARNING: *The GP-03 is not in operation as a gas detector while in Setup Mode. Although it will respond to gas in parts of AIR CAL, A--CAL, and M--CAL, there are no gas alarm indications.*

1. Take the GP-03 to a non-hazardous area and turn it off if it is on.
2. Press and hold the AIR button, then press and hold the POWER MODE button. You will hear a beep after one second. Continue to hold both the AIR and the POWER MODE buttons.

3. After three seconds you will hear a second beep. Release both buttons when you hear the second beep.
4. If the PASS--W menu item is set to *On*, the following screen will appear with the first digit flashing prompting you to enter the password.

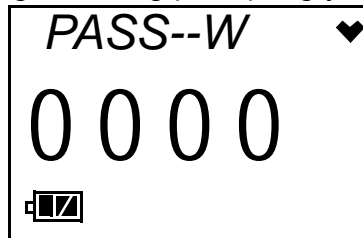

- Use the AIR button to scroll through the numbers 0-9 until you arrive at the desired value, then press and release the POWER MODE button to accept the value.
- Repeat the above procedure for each digit.
- When you have set and accepted the last digit of the password, the first menu item in Setup Mode will appear, the DATE Screen.

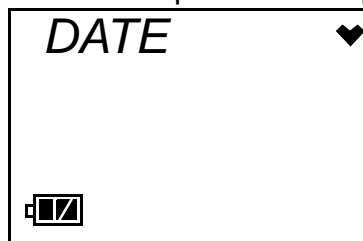

- If you entered the incorrect password, an error screen will appear. You must use the POWER MODE button to turn the unit off and try again if you wish to enter Setup Mode or turn on the unit and proceed to Measuring Mode.

NOTE: If you have forgotten your password, contact RKI Instruments, Inc.

5. If the PASS--W menu item is set to *OFF*, the DATE Screen is displayed.

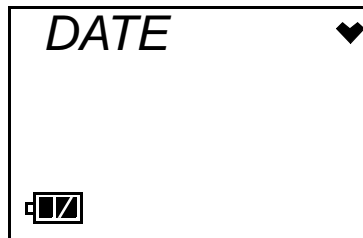

6. Use the AIR button to move forward through Setup Mode. When you get to the last menu item, the START menu item, continuing will take you to the beginning of the menu.
7. When you arrive at the item you wish to enter, press and release the POWER MODE button to enter that item.

8. When you need to adjust the numerical value of a parameter, increase it or decrease it, use the AIR button to change the value. When adjusting a numerical parameter value, it is possible to reverse the direction of adjustment. To switch from increasing to decreasing a value or decreasing to increasing a value, do the following:
 - with the parameter flashing on the screen, press and hold the AIR button
 - immediately press the POWER MODE button and then release both buttons
 - the direction of adjustment when you press the AIR button is now reversed
9. When you are done using the menu items in Calibration Mode, use the AIR button to scroll through the menu items to the START item.



10. At the START screen, press and release the POWER MODE button. The GP-03 will begin its start-up sequence.

The Setup Mode menu items are described below in the order in which they appear while moving through Setup Mode.

Setting the Date and Time in DATE

See “Setting the Date and Time” on page 35 for instructions to set the date and time.

Performing a Fresh Air Adjustment in AIR

See “Performing a Fresh Air Adjustment” on page 35 for instructions to perform a fresh air adjustment.

Performing an Automatic Span Adjustment in A--CAL

See “Performing an Automatic Span Adjustment in A--CAL” on page 36 for instructions to perform a span adjustment in A--CAL.

Performing an Easy Span Adjustment in E--CAL

See “Performing an Easy Span Adjustment in E--CAL” on page 41 for instructions to perform an easy calibration in E--CAL.

Performing a Manual Span Adjustment in M--CAL

See “Performing a Manual Span Adjustment in M--CAL” on page 46 for instructions to perform a span adjustment in M--CAL.

Setting the Alarm Points

Entering the ALM--P menu item allows you to set the alarm points.

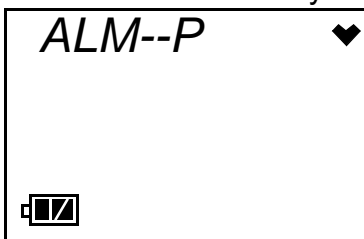

Table 6 below lists the factory set alarm points for the GP-03.

Table 6: Factory Set Alarm Points

Warning	Alarm
10% LEL	50% LEL

The alarms are increasing alarms, meaning the alarm condition actuates when the gas level increases above the alarm point.

The Warning setting cannot be adjusted higher than the Alarm setting.

1. At the ALM--P screen, press and release the POWER MODE button. The following screen will display and the Warning alarm point will be flashing.

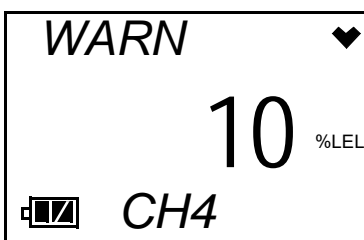

2. Use the AIR button to adjust the Warning setpoint to the desired value.
3. Press and release the POWER MODE button to save the new Warning setpoint. A screen with the Alarm setpoint flashing is displayed.

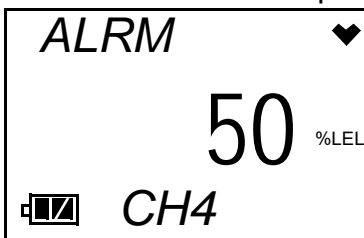

4. Use the AIR button to adjust the Alarm setpoint to the desired value.

- Press and release the POWER MODE button to save the new Alarm setpoint. The display will return to the following screen.

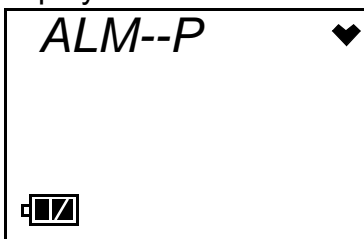

Adjusting the Bump Test Limit Check Setting

You can select how the instrument's warmup sequence will handle a bump test being due using the BP--CHK. menu item. This menu item will always appear in Setup Mode even if **Bump Test Function** and/or **Bump Limit Display** are set to *Off* in the 03 Series User Setup Program.

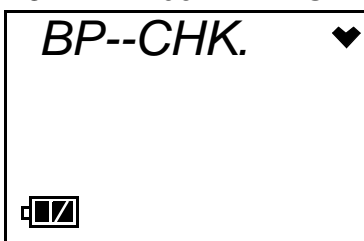

- At the BP--CHK. screen, press and release the POWER MODE button. The following screen will display and the current setting will be displayed.

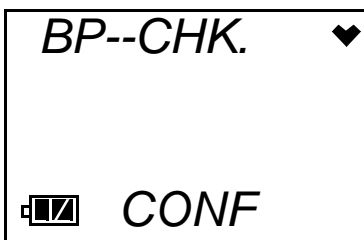

- Use the AIR button to scroll through the options. CONF is the factory setting.

Table 7: Bump Test Limit Check Options

Operation Selection	Description
CANT	Instrument cannot be used until a successful bump test is performed.
CONF (factory setting)	The user must press and release the AIR button to acknowledge that a bump test is due or press and release the POWER MODE button to perform a bump test before continuing with the warmup sequence.

Table 7: Bump Test Limit Check Options

Operation Selection	Description
NONE	The instrument screen indicates a bump test is due upon startup but continues with the warmup sequence.

- When the desired operation is displayed, press and release the POWER MODE button to select it. The display will return to the BP--CHK. menu item.

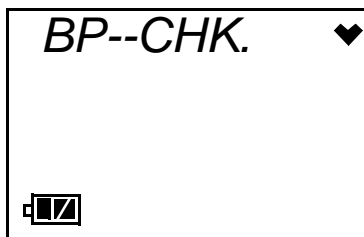

Setting the Password

You can password protect entry into the Setup Mode with the password feature. Entering the PASS--W menu item allows you to turn this feature on or off and enter a password if you turn it on.

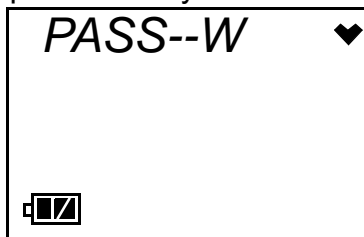

The factory setting for the password feature is OFF.

- At the PASSWORD screen, press and release the POWER MODE button. A screen will appear that shows the current password feature setting.

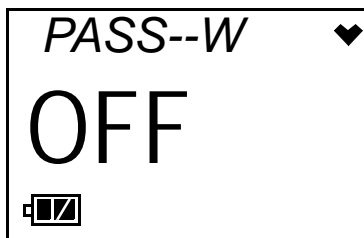

- Press and release the AIR button to change the displayed setting. When the desired setting is displayed, press and release the POWER MODE button to save the setting.

3. If the password feature was set to *OFF*, the unit will exit the *PASS--W* menu item and return to the *PASS--W* screen.

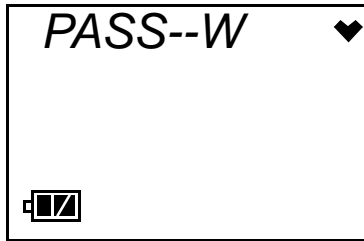

With the password feature set to *OFF*, you will be able to enter Setup Mode without entering a password.

4. If the password feature was set to *On*, the following screen will appear with the first digit flashing prompting you to enter the password you want to use. The factory set password is 0300 but it can be changed.

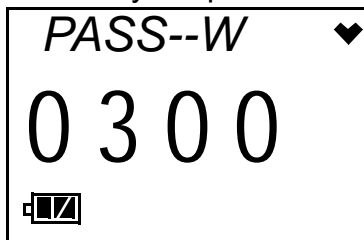

5. Use the AIR button to scroll through the numbers 0 - 9.
6. When the desired number is displayed for the first digit, press and release the POWER MODE button to save the number.
7. The next digit will begin flashing.
8. Repeat Step 5 through Step 7 until you have set all four of the digits.
9. When you save the last digit, the unit will return to the PASSWORD screen.

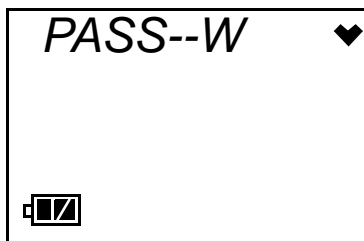

Maintenance

This section describes troubleshooting procedures for the GP-03. It also describes how to change the GP-03's batteries, replace the sensor, replace the H₂S filter disk (if used), and replace the sensor membrane.

WARNING: *RKI Instruments, Inc. recommends that service, calibration, and repair of RKI instruments be performed by personnel properly trained for this work. Replacing sensors and other parts with original equipment does not affect the intrinsic safety of the instrument but replacing sensors and other parts with substitution equipment may impair the intrinsic safety.*

AVERTISSEMENT: *RKI Instruments, Inc. recommande que le service, l'étalonnage et la réparation des instruments RKI être effectuées par du personnel qualifié pour ce travail. Remplacement des capteurs et des autres parties avec l'équipement d'origine ne affecte pas la sécurité intrinsèque de l'instrument, mais en remplaçant les capteurs et autres pièces avec des équipements de substitution peut compromettre la sécurité intrinsèque.*

Troubleshooting

The troubleshooting table describes error messages, symptoms, probable causes, and recommended actions for problems you may encounter with the GP-03.

Table 8: Troubleshooting the GP-03

Symptoms	Probable Causes	Recommended Action
The LCD is blank.	<ul style="list-style-type: none">• The unit may have been turned off.• The batteries may need to be replaced.	<ol style="list-style-type: none">1. To turn on the unit, press and hold the POWER MODE button.2. If the unit does not turn on, replace the batteries.3. If the difficulties continue, contact RKI Instruments, Inc. for further instruction.

Table 8: Troubleshooting the GP-03

Symptoms	Probable Causes	Recommended Action
The LCD shows abnormally high readings but other gas detection instruments do not.	<ul style="list-style-type: none"> • The unit may need to be recalibrated. • The sensor may need replacement. 	<ol style="list-style-type: none"> 1. Recalibrate the unit. 2. Replace the sensor and calibrate the unit. 3. If the difficulties continue, contact RKI Instruments, Inc. for further instruction.
No or low response to a known concentration of combustible gas.	<ul style="list-style-type: none"> • If installed, the H₂S filter disk may be absorbing the gas. • The unit may need to be recalibrated. • The sensor may need replacement. 	<ol style="list-style-type: none"> 1. If installed, remove the H₂S filter disk and see if the response improves. 2. Recalibrate the unit. 3. Replace the sensor and calibrate the unit. 4. If the difficulties continue, contact RKI Instruments, Inc. for further instruction.
"FAIL" displays during span adjustment.	<ul style="list-style-type: none"> • The calibration value may not match the cylinder gas concentration. • The sample gas is not reaching the sensor because of a bad connection. • The calibration cylinder may be out of gas or is outdated. • The sensor may need replacement. 	<ol style="list-style-type: none"> 1. Check all calibration tubing for leaks or for any bad connections. 2. Make sure the GP-03 has been properly set up for calibration. 3. Verify that the calibration cylinder contains an adequate supply of fresh test sample. 4. If the fail condition continues, replace the sensor. 5. If the difficulties continue, contact RKI Instruments, Inc. for further instruction.
"SYSTEM FAIL" is displayed on the LCD	<ul style="list-style-type: none"> • A microprocessor failure has occurred. 	<ol style="list-style-type: none"> 1. Turn off the unit and turn it on again. 2. If difficulties continue, contact RKI Instruments, Inc.

Replacing or Recharging the Batteries

WARNING: *To prevent ignition of a hazardous atmosphere, batteries must only be changed in an area known to be nonhazardous.*

AVERTISSEMENT: *Pour éviter l'inflammation d'une atmosphère dangereuse, les batteries doivent uniquement être modifiés ou facturés dans une zone connue comme non dangereuse.*

NOTE: Use Duracell MN2400 or PC2400 or Eneloop BK-4MCC to maintain the CSA classification of the GP-03. Use of other batteries will void the CSA classification and may void the warranty. Do not mix old/new or different types of batteries.

NOTE: Utiliser Duracell MN 2400 ou PC 2400 ou Eneloop BK-4MCC de maintenir la classification CSA de la GP-03. L'utilisation d'autres piles annule la classification CSA et peut annuler la garantie. Ne mélangez pas les anciennes/nouvelles ou différents types de piles.

Replace the batteries when the battery icon indicates that the unit is in low battery warning. When in low battery warning, only one battery level indication bar is displayed in the battery icon on the LCD, and this icon will be flashing.



To Replace the Batteries

1. Verify that the GP-03 is off.
2. Release the left side of the alligator clip or belt clip (if installed).

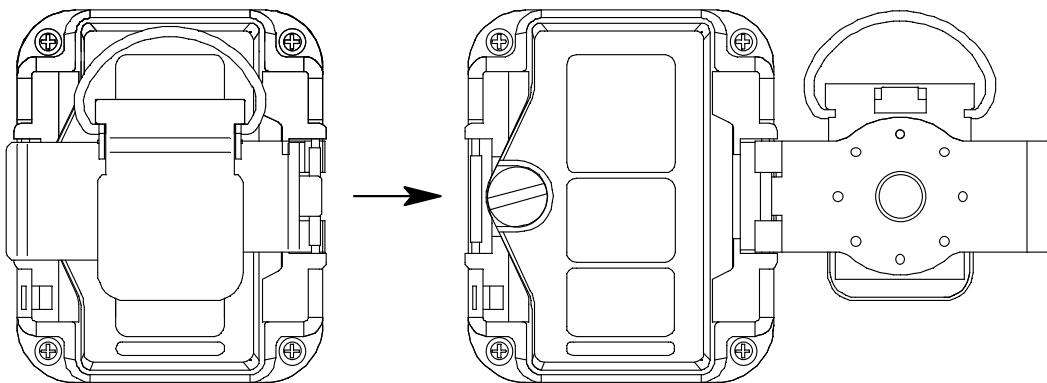

Figure 13: Clip Release

3. Rotate the captive battery cover screw counterclockwise to remove the battery cover.

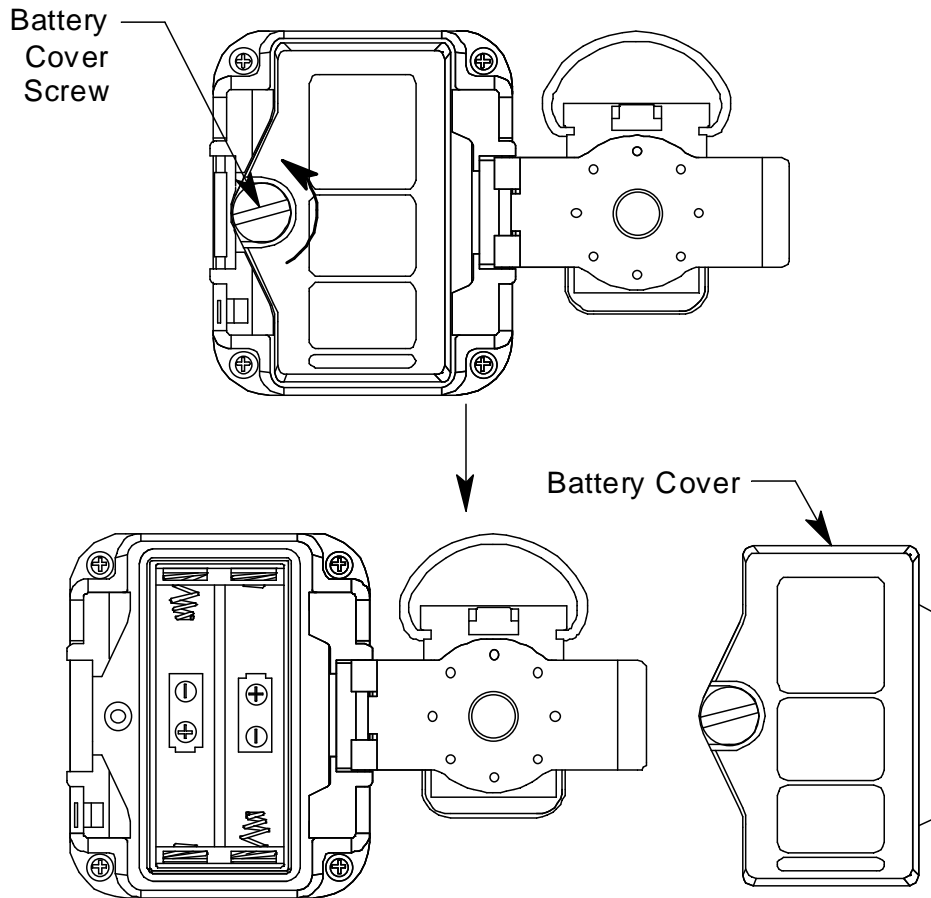

Figure 14: Removing the Battery Cover

4. Carefully remove the old alkaline or Ni-MH batteries.

NOTE: To avoid having to reset the date and time, new batteries must be installed within 5 minutes.

5. Carefully install the new AAA alkaline or Ni-MH batteries. Follow the battery diagram inside the battery compartment.
6. Reinstall the battery cover.
7. If the instrument has been without batteries for more than 5 minutes, the date and time are reset and need to be set again. When the new batteries are installed, the instrument will turn on automatically and will display the Date/Time Screen. Set the date and time as described in "Setting the Date and Time" on page 35. Once the date and time have been set, the instrument will begin its warmup sequence. If you do not set the date and time within 30 seconds, the instrument will automatically begin its warmup sequence.

To Recharge Ni-MH Batteries

Any battery charger capable of charging AAA Ni-MH batteries can be used to recharge the GP-03's Ni-MH batteries. RKI Instruments, Inc. recommends using one of the chargers specified in the "Parts List" on page 71.

WARNING: *To prevent ignition of a hazardous atmosphere, batteries must only be charged in an area known to be nonhazardous.*

1. Remove the batteries from the GP-03 as described in Step 1 - Step 4 on page 65.
2. Install the Ni-MH batteries in the charger. See the battery charger's operator's manual for charging instructions.
3. Put the batteries back in the GP-03 and reinstall the battery cover.

Replacing the Sensor

WARNING: *Replace the sensor in a non-hazardous environment.*

NOTE: An alligator or belt clip may be installed on the instrument but is not shown in the figures in this section.

1. Verify that the GP-03 is off.
2. Remove the rubber boot, if installed.
3. With a small Phillips screwdriver, carefully unscrew the four screws that attach the rear case to the front case.
4. Turn the instrument right side up. The screws are not captive and will fall out. Be sure not to lose them.

5. Remove the front case from the rear case.

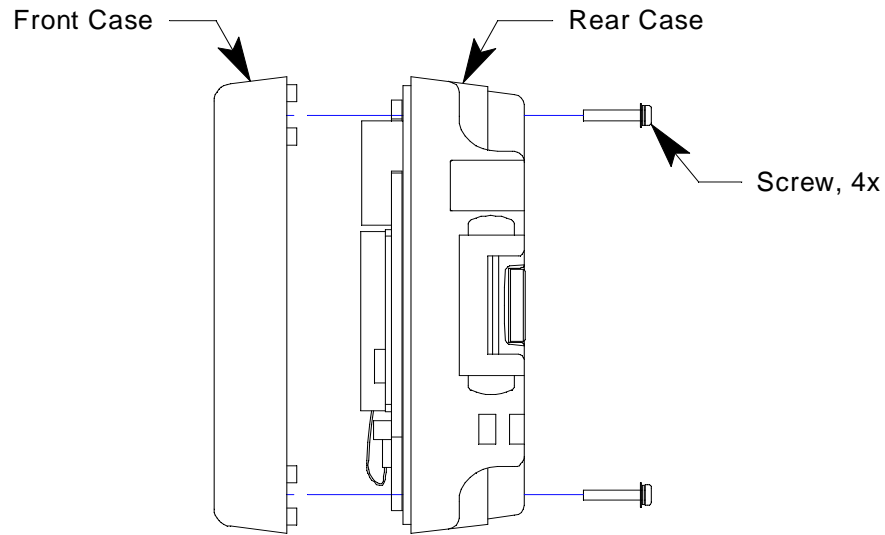

Figure 15: Case Separation

6. Carefully remove the old sensor from the sensor socket.

7. Carefully insert the replacement sensor in the socket. Make sure the sensor face with the yellow colored ring is facing up and that the sensor contacts line up with the contacts in the sensor socket.

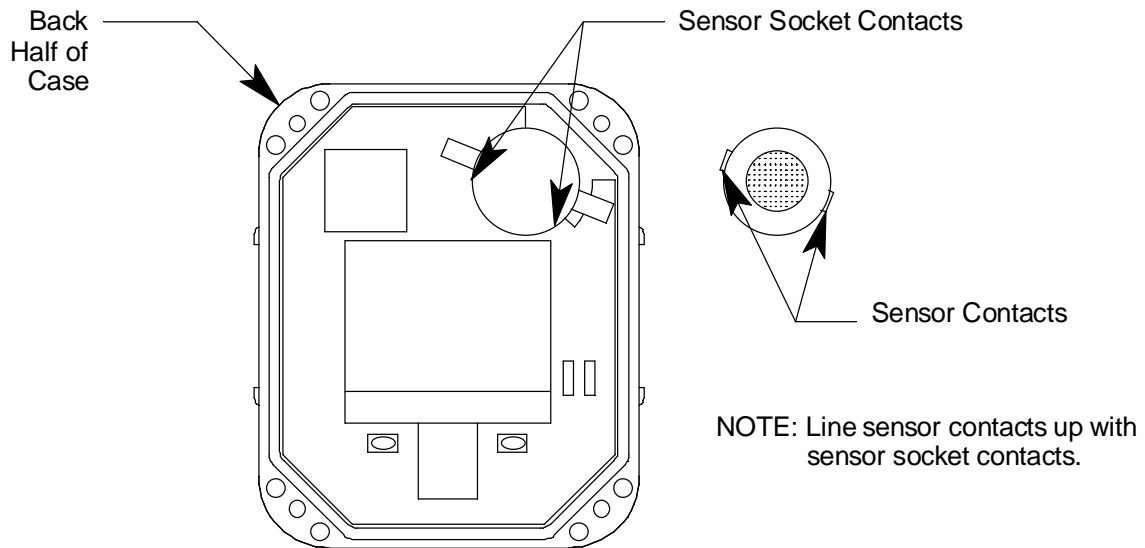

Figure 16: Replacing the Sensor

CAUTION: *When replacing the sensor, verify that the sensor is properly aligned with its socket before inserting it into the socket. Forcing a sensor into its socket may damage the sensor or the socket.*

8. Reinstall the front case to the rear case.
9. Screw in the 4 screws that were removed in Step 3.
10. Reinstall the rubber boot if it is being used.
11. Calibrate the new sensor as described in “Calibration Mode” on page 33.

Replacing the Sensor Membrane and H₂S Filter Disk

When replacing the sensor filters, it is recommended that you replace both filters at the same time.

The H₂S filter disk is dark red in color and although it may darken over time, its color is not indicative of remaining filter life. The H₂S filter disk can absorb H₂S for 33 ppm hours and should be replaced after that much exposure. With this many ppm hours of absorption, the H₂S filter disk should be replaced after 80 minutes of exposure to 25 ppm H₂S. This equates to replacing the H₂S filter disk after 40 2-minute calibrations with a cylinder containing 25 ppm H₂S. If H₂S exists in the monitoring environment, the H₂S filter disk will have to be replaced more frequently.

NOTE: The H₂S filter disk is not installed as shipped from the factory. See “Combustible Gas Detection” on page 23 for a discussion of when it should be installed.

WARNING: *Replace the sensor membrane and H₂S filter disk in a non-hazardous environment.*

NOTE: An alligator or belt clip may be installed on the instrument but is not shown in the figures in this section.

1. Verify that the GP-03 is off.
2. Remove the rubber boot, if installed.
3. With a small Phillips screwdriver, carefully unscrew the four screws that attach the rear case to the front case.
4. Turn the instrument right side up. The screws are not captive and will

fall out. Be sure not to lose them.

5. Remove the front case from the rear case.

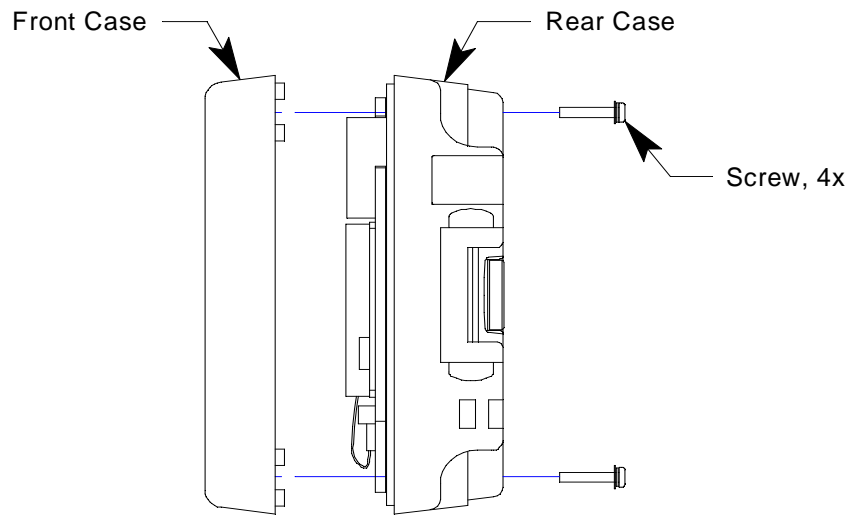

Figure 17: Case Separation

6. Turn the front case upside down so that the sensor gasket is visible.

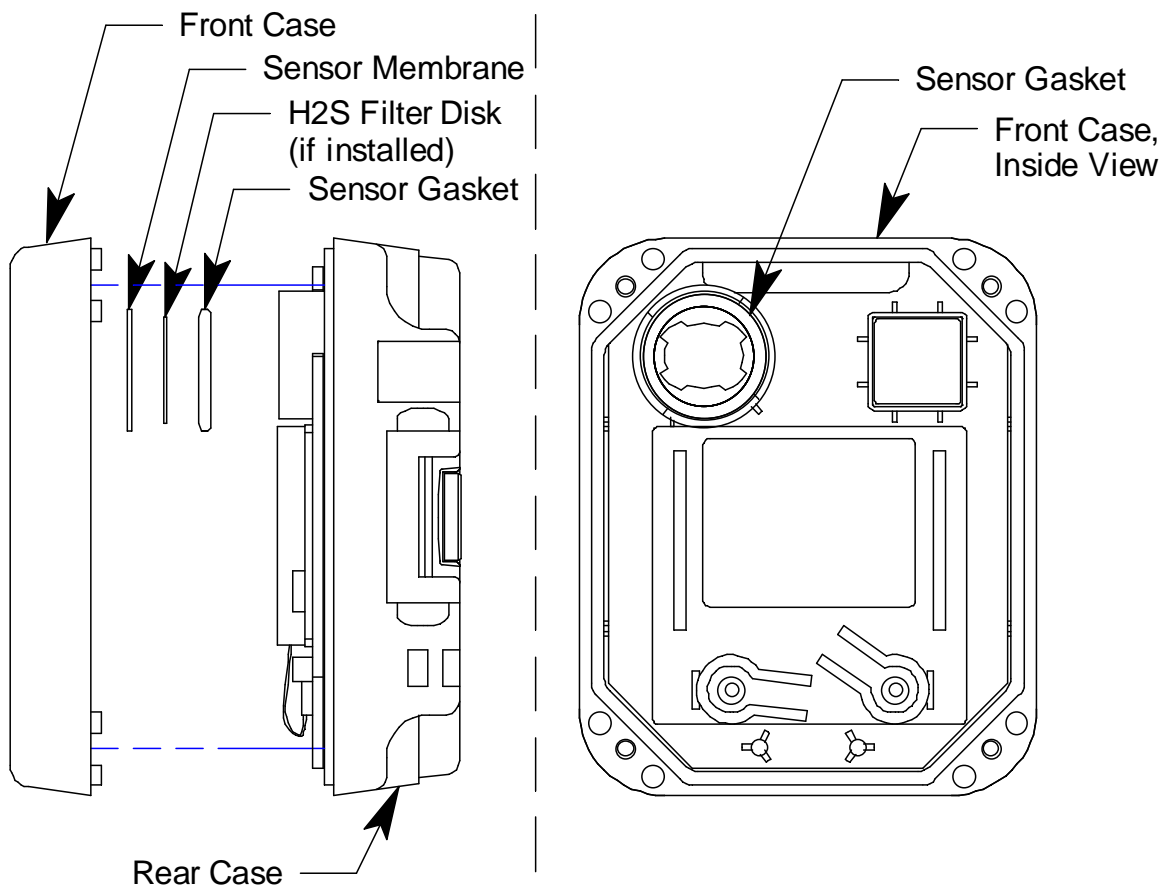

Figure 18: Replacing the Sensor Membrane and H2S Filter Disk

7. Carefully remove the sensor gasket. The dark red H₂S filter disk (if installed) will be installed in the sensor gasket. Carefully remove the H₂S filter disk from the sensor gasket. The white sensor membrane will be accessible once the sensor gasket has been removed. Carefully remove the sensor membrane.
8. Insert a new sensor membrane in the sensor membrane recess.
9. Install a new H₂S filter disk (if installed) into the recess in the sensor gasket. There are tabs on either side of the recess that will hold the H₂S filter disk in place.

NOTE: The H₂S filter disk is not installed as shipped from the factory. See “Combustible Gas Detection” on page 23 for a discussion of when it should be installed.

10. Reinstall the sensor gasket with the flat side down.
11. Turn the front case right side up and carefully secure it to the rear case using the screws you removed in Step 3.
12. Reinstall the rubber boot if it is being used.

Parts List

Table 6 lists replacement parts and accessories for the GP-03.

Table 9: Parts List

Part Number	Description
06-1248RK	Calibration kit tubing (specify length in feet)
07-6031	Gasket for battery cover
07-6032	Gasket between front and rear cases
07-6033	Sensor gasket
10-1105-01	Screw, M2X 8mm pan head Phillips with washer, SUSXM7, for connecting front and rear cases
13-0112RK	Wrist strap
13-0121	Alligator clip
13-0122	Belt clip
13-0204RK	Spring bars for alligator and belt clips
13-1116	Captive battery cover screw

Table 9: Parts List

Part Number	Description
20-0325	Rubber boot
33-0175	Sensor membrane
33-7114RK	H ₂ S filter disk, 5 pack
47-5084RK	USB/IrDA adapter module, Legasic, for use with all premier portables (without USB cable)
47-5084RK-01	USB/IrDA adapter assembly, Legasic, for use with all premier portables (with module and USB cable)
47-5085RK	Cable, USB A to USB mini, 6 feet, for 47-5084RK USB/IrDA adapter module
47-5093	USB/IrDA adapter with cable and CD (not for use with Eagle 2)
49-1110RK	AAA size alkaline battery
49-1312	AAA size Ni-MH battery
49-3105RK	4-battery AA/AAA charger with AC adapter and DC vehicle adapter
49-3106RK	12-battery AA/AAA charger with AC adapter
81-0007RK-01	Calibration cylinder, 15% LEL hexane in air, 34 liter steel
81-0012RK-01	Calibration cylinder, 50% LEL methane in air, 34 liter steel
81-0012RK-03	Calibration cylinder, 50% LEL methane in air, 103 liter
81-0078RK-01	Calibration cylinder, 100% nitrogen, 34 liter steel
81-1050RK	Regulator, with gauge and knob, 0.5 liter/minute continuous flow, for 17 liter and 34 liter steel calibration cylinders (cylinders with external threads)
81-1051RK	Regulator, with gauge and knob, 0.5 liter/minute continuous flow, for 34 liter aluminum/58 liter/103 liter calibration cylinders (cylinders with internal threads)
81-1146	Calibration adapter for GP-03
81-GP03	Calibration kit for GP-03 containing: one 103-liter steel gas cylinder (50 %LEL methane in air), regulator, calibration adapter, case, tubing

Table 9: Parts List

Part Number	Description
81-GP03-LV	Calibration kit for GP-03 containing: one 34-liter steel gas cylinder (50 %LEL methane in air), regulator, calibration adapter, case, tubing
81-GP03H-LV	Calibration kit for GP-03 containing: one 34-liter steel gas cylinder (15 %LEL hexane in air), regulator, calibration adapter, case, tubing
NC-6264A	Combustible LEL sensor

CALL GEOTECH TODAY

(800) 833-7958

Geotech Environmental Equipment, Inc.

2650 East 40th Avenue • Denver, Colorado 80205

(303) 320-4764 • FAX (303) 322-7242

email: sales@geotechenv.com • website: www.geotechenv.com