

For Sales & Service Contact

geotech

2650 E. 40th Ave. • Denver, CO 80205
Phone 303-320-4764 • Fax 303-322-7242

1-800-833-7958

www.geotechenv.com

CO-04

Operator's Manual

Part Number: 71-0600

Revision: 0

Released: 12/8/22

RKI Instruments, Inc.
www.rkiinstruments.com

WARNING

Read and understand this instruction manual before operating instrument. Improper use of the gas monitor could result in bodily harm or death.

Maintenance of the gas monitor is essential for proper operation and correct readings.

Bump test the instrument before each day's use with a known concentration of the target gas. A bump test can be done in User Mode's BUMP item or by applying gas in Measuring Mode. The instrument does not need to be calibrated unless it does not pass the User Mode bump test or does not respond appropriately, as defined by the user, in Measuring Mode. For more information about bump test and calibration requirements, see IEC 60079-29-2.

Table of Contents

| | |
|---|-----------|
| Chapter 1: Introduction | 7 |
| Overview | 7 |
| About the CO-04 | 7 |
| Specifications | 8 |
| About this Manual | 10 |
| | |
| Chapter 2: Description | 10 |
| Overview | 10 |
| Instrument Description | 10 |
| <i>Case</i> | 10 |
| <i>LCD</i> | 10 |
| <i>Control Buttons</i> | 11 |
| <i>Alarm LED</i> | 11 |
| <i>Buzzer</i> | 11 |
| <i>Vibrator</i> | 11 |
| <i>Sensor</i> | 12 |
| <i>Filters</i> | 12 |
| <i>Infrared Communications Port</i> | 12 |
| <i>Batteries</i> | 12 |
| Standard Accessories | 13 |
| <i>Alligator Clip</i> | 13 |
| Optional Accessories | 14 |
| <i>Watch Band</i> | 14 |
| <i>Calibration Cup</i> | 15 |
| <i>IrDA/USB Cable</i> | 15 |
| | |
| Chapter 3: Measuring Mode | 16 |
| Overview | 16 |
| Start Up | 16 |
| <i>Turning On the CO-04</i> | 16 |
| <i>Performing a Demand Zero</i> | 21 |
| <i>Turning Off the CO-04</i> | 21 |

| | |
|-----------------------------------|----|
| Measuring Mode Operation | 22 |
| <i>Monitoring an Area</i> | 22 |
| Alarms | 23 |
| <i>Alarm Indications</i> | 23 |
| <i>Responding to Alarms</i> | 25 |
| Data Logging | 28 |

Chapter 4: Display Mode29

| | |
|--|----|
| Tips for Using Display Mode | 29 |
| Peak Screen (PEAK)..... | 30 |
| STEL Screen (STEL) | 30 |
| TWA Screen (TWA) | 31 |
| User ID Screen (USER ID)..... | 31 |
| Station ID Screen (STN ID) | 32 |
| Last Successful Calibration Date (CAL.DATA)..... | 32 |
| Last Successful Bump Test Screen (BP.DATA) | 33 |
| Date/Time Screen (DATE) | 33 |
| Temperature Screen (TEMP) | 34 |
| Alarm Points Screen (ALARM--P) | 34 |
| Adjusting the Buzzer Volume (BUZZ.VOL) | 35 |

Chapter 5: User Mode and Calibration.....36

| | |
|--|----|
| Overview..... | 36 |
| Entering User Mode | 39 |
| Tips for Using User Mode | 40 |
| Performing a Bump Test (BUMP) | 41 |
| Performing a Calibration (GAS CAL) | 43 |
| Setting Calibration Parameters (CAL SET) | 53 |
| Setting Bump Test Parameters (BUMP.SET)..... | 55 |
| Alarm Settings (ALARM--P)..... | 60 |
| Updating the Lunch Break Setting (LUNCH) | 62 |
| Setting the Confirmation Beep and Non-Compliance Indicator (BEEP)..... | 62 |
| Updating the Backlight Time (BL TIME)..... | 64 |
| Turning the Key Tone On/Off (KEY.TONE) | 64 |

| | |
|--|-----------|
| Display Mode Items (DISP.SET) | 65 |
| Zero Suppression (ZERO.SUP) | 65 |
| Zero Follower (ZERO.FLW) | 65 |
| Turning Easy Calibration On/Off (E-CAL) | 66 |
| Setting the Date/Time (DATE) | 66 |
| Turning the Password On/Off (PASS-W) | 67 |
| Viewing the ROM/SUM (ROM/SUM) | 68 |
| Entering Measuring Mode (START) | 68 |
| Chapter 6: Maintenance | 69 |
| Overview | 69 |
| Troubleshooting | 69 |
| Replacing the Batteries | 70 |
| Replacing the Charcoal Filter | 73 |
| Replacing the Hydrophobic Filter | 75 |
| Replacing the Sensor | 77 |
| Chapter 7: General Parts List | 79 |
| Appendix A: Maintenance Mode | 81 |
| Overview | 81 |
| Entering Maintenance Mode | 82 |
| Tips for Using Maintenance Mode | 83 |
| Performing a Calibration (GAS CAL) | 84 |
| Performing a Gas Test (GAS.TEST) | 84 |
| Sensor/Battery Replacement Date (SEN.DATE) | 85 |
| Performing a Bump Test (BUMP) | 86 |
| Setting Alarms to Latching or Self-Resetting (LATCH) | 86 |
| Turning the Demand Zero Function On/Off (D.ZERO) | 87 |
| Turning the Auto Zero Function On/Off (A.ZERO) | 87 |
| Turning the ID Display Function On/Off (ID DISP) | 88 |
| Turning the Zero Suppression On/Off (ZERO.SUP) | 88 |
| Turning the Zero Follower On/Off (ZERO.FLW) | 88 |
| User Mode Zero Suppression (ZSUP.DSP) | 88 |

| | |
|---|----|
| User Mode Zero Follower (ZFLW.DSP) | 89 |
| Cylinder Setting (CYL.DISP)..... | 89 |
| Setting the Date/Time (DATE) | 89 |
| Turning the Password On/Off (PASS-W)..... | 90 |
| Viewing the ROM/SUM (ROM/SUM)..... | 91 |
| Performing a Default (M.DEF)..... | 91 |
| Entering Measuring Mode (START) | 92 |

Appendix B: Gas Select Mode93

| | |
|---|----|
| Overview..... | 93 |
| Entering Gas Select Mode | 93 |
| Tips for Using Gas Select Mode..... | 94 |
| Saving the Alarm Points (SAVE-AP) | 94 |
| Turning the Calibration Max Span On/Off (MAX.SPAN)..... | 95 |
| Stealth and Vibrator Settings (STEALTH)..... | 96 |
| Exiting Gas Select Mode (START)..... | 96 |

Warranty97

WARNING: Understand manual before operating. This is an intrinsically safe product. Substitution of components may impair intrinsic safety. To prevent ignition of a hazardous atmosphere, batteries must only be changed or charged in an area known to be nonhazardous. Not tested in oxygen enriched atmospheres (above 21%).

AVERTISSEMENT: Comprendre le manuel avant de l'utiliser. Ceci est un produit intrinsèquement sûr. La substitution de composants peut nuire à la sécurité intrinsèque. Pour éviter l'inflammation d'une atmosphère dangereuse, les batteries ne doivent être remplacées ou chargées que dans une zone non dangereuse. Non testé dans des atmosphères enrichies en oxygène (plus de 21%).

Chapter 1: Introduction

Overview

This chapter briefly describes the CO-04 gas monitor. This chapter also describes the *CO-04 Operator's Manual* (this document). Table at the end of this chapter lists the specifications for the CO-04.

About the CO-04

Using an advanced detection system, the CO-04 personal gas monitor detects the presence of carbon monoxide (CO). The CO-04's compact size and easy-to-use design make it ideally suited for a wide range of applications, including sewage treatment plants, utility manholes, tunnels, hazardous waste sites, power stations, petrochemical refineries, mines, paper mills, drilling rigs, and fire fighting stations. The CO-04 offers a full range of features, including:

- Liquid crystal display (LCD) for complete and understandable information at a glance
- Ultrabright alarm LED
- Distinctive audible/vibrating alarms for dangerous gas conditions and audible alarms for unit malfunction
- Microprocessor control for reliability, ease of use, and advanced capabilities
- Data logging functions
- Alarm trend data
- STEL, TWA, and over range alarms
- Peak reading
- Built-in time function
- Lunch break feature
- QPS "C/US" classification for Class I, Division I, Groups A, B, C, and D hazardous atmospheres

WARNING: The Model CO-04 detects elevated levels of carbon monoxide which can be dangerous or life threatening. When using the CO-04, you must follow the instructions and warnings in this manual to assure proper and safe operation of the unit and to minimize the risk of personal injury. Be sure to maintain and periodically calibrate the CO-04 as described in this manual.

AVERTISSEMENT: *Le modèle CO-04 détecte les niveaux élevés de monoxyde de carbone qui peuvent être dangereux ou mettre la vie en danger. Lorsque vous utilisez le CO-04, vous devez suivre les instructions et les avertissements de ce manuel pour assurer un fonctionnement correct et en toute sécurité de l'appareil et pour réduire les risques de blessures. Assurez-vous de maintenir et d'étalonner périodiquement le CO-04 comme décrit dans ce manuel.*

Specifications

Table 1: Standard Sensor Specifications/Alarm Points

| | |
|--------------------------------------|---|
| Detection Range | 0 - 2,000 ppm |
| Lowest Detectable Limit (LDL) | 3 ppm |
| Reading Increment | 0 - 300 ppm: 1 ppm 310 - 2,000 ppm: 10 ppm |
| Warning Factory Setting | 25 ppm |
| Alarm Factory Setting | 50 ppm |
| Alarm H Factory Setting | 1,200 ppm |
| STEL Alarm | 200 ppm |
| TWA Alarm | 25 ppm |

Table 2: CO-04 Specifications

| | |
|---|---|
| Sampling Method | Diffusion |
| Response Time | T90 Within 10 Seconds |
| Display | Graphics LCD Display |
| Operating Temperature & Humidity | Continuous environment: -20°C to 50°C/10 to 90% RH Temporary environment (up to 15 minutes): -40°C to 60°C/0 to 95% RH |
| Safety/Regulatory | <ul style="list-style-type: none"> • ATEX: Certificate Number DEKRA 19ATEX0097 II 1G Ex ia IIC T4 Ga (with alkaline batteries) II 1G Ex ia IIC T3, Ga (with Ni-MH batteries) • IECEx: Certificate Number IECEx DEK 19.0059 Ex ia IIC T4 Ga (with alkaline batteries) Ex ia IIC T3 Ga (with Ni-MH batteries) • QPS classified, "C/US", as Intrinsically Safe. Exia. Class I, Groups A, B, C, & D. |

Table 2: CO-04 Specifications

| | |
|---|---|
| Instrument Power Information | <ul style="list-style-type: none">• Operating Voltage: 3.0V• Operating Current: 1.0 mA• Operating Power: 3.0 mW |
| Power Supply | 2 AAA alkaline batteries; 1.5V, 1.175 AH (Duracell MN2400 or PC2400) <u>OR</u> 2 AAA Ni-MH batteries; 1.2V, 800 mAH (Panasonic Eneloop BK-4MCC) |
| Continuous Operating Hours @ 25 °C | Alkaline Batteries: 9,000 hours in Measuring Mode (Non Alarm Operation, Fully Charged) Ni-MH Batteries: 6,000 hours in Measuring Mode (Non Alarm Operation, Fully Charged) |
| Case | High-impact Plastic, RF Shielded, Dust and Weather Proof (IP67) |
| Standard Accessories | <ul style="list-style-type: none">• Alligator clip• Rubber boot |
| Optional Accessories | <ul style="list-style-type: none">• Belt clip• Calibration cup• Datalogging and Setup Programs (Windows® 7, 8, 10, and 11), available at www.rkiinstruments.com/04series• IrDA/USB Cable for connecting to a computer when using the Datalogging and Setup Programs (not needed if computer has an infrared port) |
| Dimensions and Weight | Approximately 67(H) x 54(W) x 24(D) mm (2.6”H x 2.1”W x 0.9”D) Approximately 93 g (3.3 oz.) |

About this Manual

The *CO-04 Operator’s Manual* uses the following conventions for notes, cautions, and warnings.

NOTE: Describes additional or critical information.

CAUTION: Describes potential damage to equipment.

WARNING: Describes potential danger that can result in injury or death.

Chapter 2: Description

Overview

This chapter describes the CO-04 instrument and its accessories.

Instrument Description

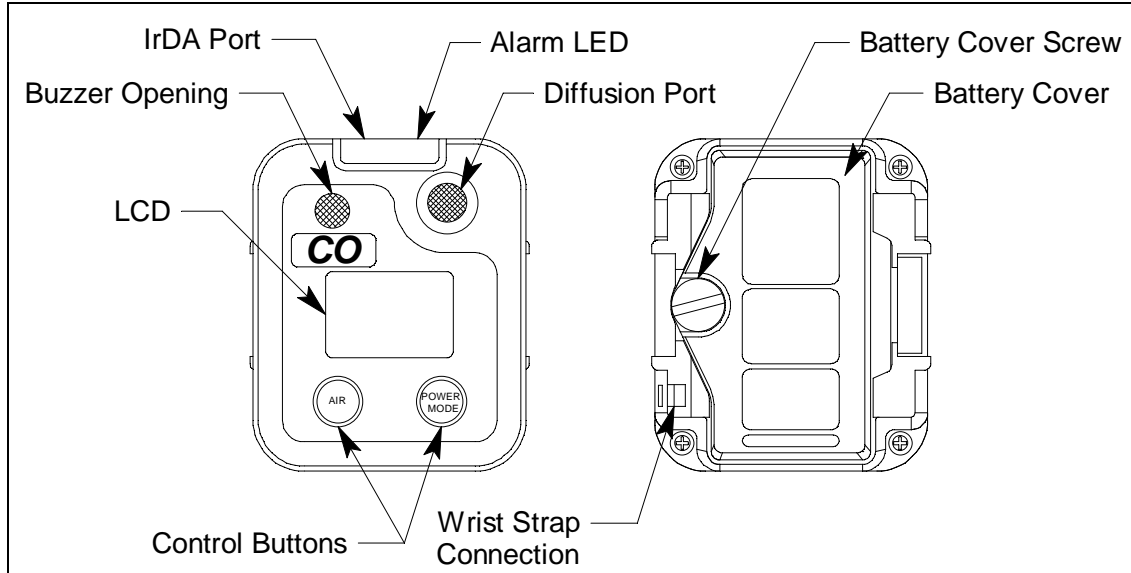

Figure 1: Component Location

Case

The CO-04's sturdy, high-impact plastic case is radio frequency (RF) resistant and is suitable for use in many environmental conditions, indoors and out. The case is dust proof and water resistant. A clear plastic window is located on the front of the case for viewing the LCD. The sensor retainer is located on the right side of the case and allows access to the filters and sensor. A feature in the lower left corner of the rear case is used to install the optional wrist strap.

LCD

A digital LCD (liquid crystal display) is visible through a clear plastic window in the top case. The LCD shows the gas reading. The LCD also shows information for each of the CO-04's operating modes.

Control Buttons

Two control buttons, AIR and POWER MODE, are located below the LCD.

Table 3: CO-04 Control Button Functions

| Button | Function(s) |
|------------|--|
| AIR | <ul style="list-style-type: none">• turns on LCD backlight• resets alarm condition if LATCH is set to ON in Maintenance Mode• enters User Mode, Maintenance Mode, and Gas Select Mode when used with POWER MODE• activates the demand zero function (adjusts the CO-04's fresh air reading)• changes the value of a parameter available for adjustment• scrolls through parameter options |
| POWER MODE | <ul style="list-style-type: none">• turns the CO-04 on and off• turns on LCD backlight• enters and scrolls through Display Mode• enters instructions into the CO-04's microprocessor• resets alarm condition if LATCH is set to ON in Maintenance Mode• enters User Mode, Maintenance Mode, and Gas Select Mode when used with AIR |

Alarm LED

The alarm LED above the sensor and buzzer openings alerts you to gas, low battery, and failure alarms.

Buzzer

One solid-state electronic buzzer is located inside the case. Sound exits the case through a hole in the upper left corner of the front case. The buzzer sounds for gas alarms, malfunctions, and low battery voltage. It also provides feedback for button presses and while in Display, User, Maintenance, or Gas Select Mode.

Vibrator

A vibrating motor inside the CO-04 case vibrates for gas alarms and unit malfunctions.

NOTE: If **STEALTH** is set to **ON**, the vibrator only functions when **VIB** in the **STEALTH** Gas Select Mode item is set to **ON** (see page 96).

Sensor

The CO sensor is an electrochemical cell that consists of two precious metal electrodes in a dilute acid electrolyte. A gas permeable membrane covers the sensor face and allows gas to diffuse into the electrolyte. The gas reacts in the sensor and produces a current proportional to the concentration of the target gas. The CO-04's circuitry amplifies the current, converts the current to a gas concentration, and displays the concentration on the LCD.

Filters

Charcoal Filter (Black)

A black charcoal filter is placed into a recess in the sensor gasket over the CO sensor. The charcoal filter disk scrubs H₂S and certain hydrocarbons out of the sample to avoid false CO readings. If false or elevated CO readings are noticed, especially in the presence of H₂S, change the charcoal filter.

Hydrophobic Filter

The white, circular hydrophobic filter fits into a recessed area in the front case and is held in place by the sensor gasket. It prevents water and particulates from entering the instrument.

Infrared Communications Port

An infrared (IR) communications port is located at the top of the instrument, near the LED. Logged data transmits through the port in standard IrDA protocol. A computer's infrared port or an IrDA/USB cable connected to a USB port can be used to download data to the 04 Series Datalogging Program. See the 04 Series Datalogging Program operator's manual for data logging and downloading instructions.

Batteries

2 AAA batteries (alkaline or Ni-MH) power the CO-04. At 25°C alkaline batteries will last at least 9,000 hours (375 days) and Ni-MH batteries will last at least 6,000 hours (250 days). The battery icon in the upper right of the LCD shows remaining battery life.

A low battery warning activates when the CO-04 detects a low battery voltage. The CO-04 sounds a dead battery alarm when battery voltage is too low for Measuring Mode.

WARNING: *Use only Duracell MN2400 or PC2400 or Eneloop BK-4MCC batteries to maintain the QPS classification of the CO-04. Use of other batteries will void the QPS classification and may void the warranty. Do not mix old/new or different types of batteries.*

AVERTISSEMENT: *Utiliser uniquement des piles Duracell MN 2400 ou PC 2400 ou Eneloop BK-4MCC de maintenir la classification QPS de la CO-04. L'utilisation d'autres piles annule la classification QPS et peut annuler la garantie. Ne mélangez pas les anciennes/nouvelles ou différents types de piles.*

WARNING: *To prevent ignition of a hazardous atmosphere, the batteries must only be changed in an area known to be nonhazardous.*

AVERTISSEMENT: *Pour éviter l'inflammation d'une atmosphère dangereuse, la batterie ne doit être remplacée que dans une zone non dangereuse.*

Standard Accessories

Alligator Clip

An alligator clip installs to 2 spring bars on the rear case. Use the alligator clip to attach the CO-04 to clothing or a belt. Teeth in the alligator clip's jaws prevent slipping. The alligator clip can be rotated to change the instrument's orientation.

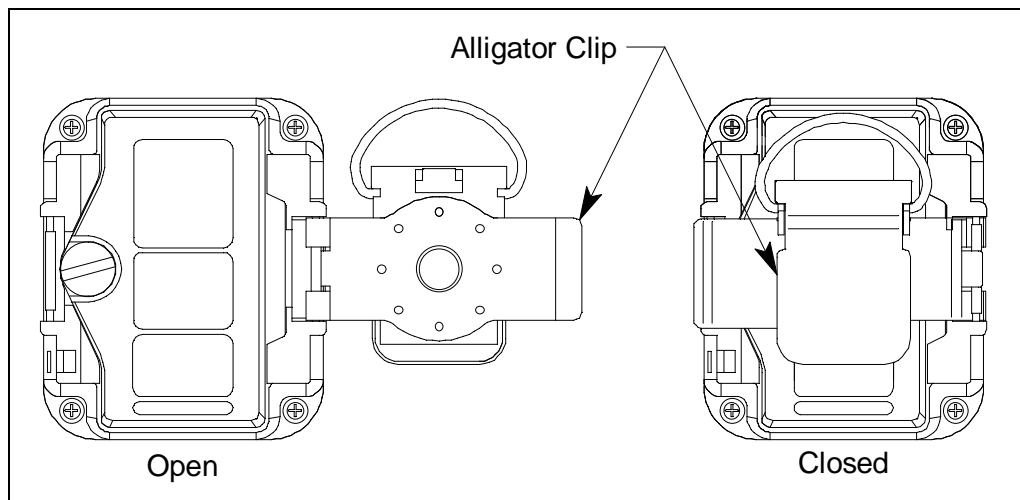

Figure 2: Alligator Clip

Protective Rubber Boot

A protective rubber boot is installed over the CO-04.

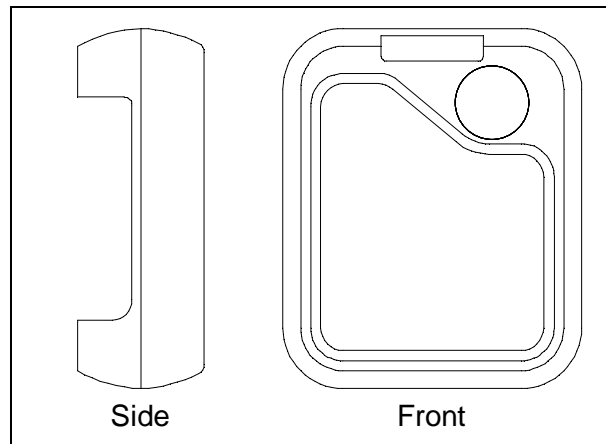

Figure 3: Rubber Boot

Optional Accessories

Belt Clip

The belt clip installs to 2 spring bars on the rear case and is used to easily clip the CO-04 onto a belt.

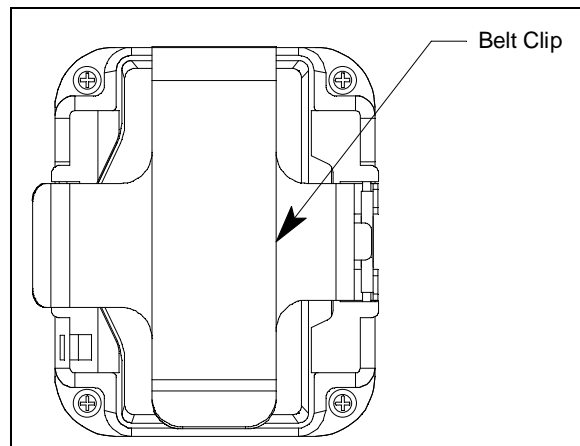

Figure 4: Belt Clip

Wrist Strap

The wrist strap connects to a feature on the back case.

Calibration Cup

The calibration cup installs over the sensor. You must use the calibration cup when performing a bump test, calibration, or gas test.

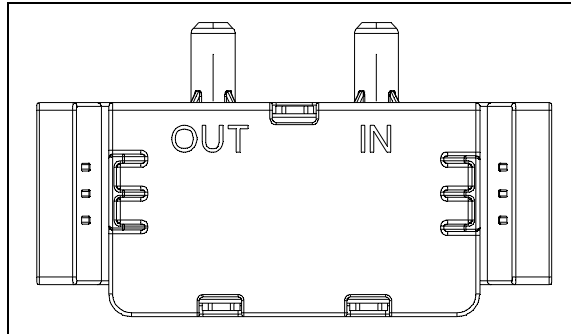

Figure 5: Calibration Cup

IrDA/USB Cable

Unless your computer has a built-in IrDA port, a IrDA/USB cable is needed to establish communication between the CO-04 and the Datalogging Program or the Setup Program.

Chapter 3: Measuring Mode

Overview

This chapter explains how to use the CO-04 to perform confined space entry monitoring or general area monitoring in Measuring Mode.

Start Up

This section explains how to start up the CO-04, get it ready for operation, and turn it off.

Turning On the CO-04

To illustrate certain functions, the following description of the CO-04 start up sequence assumes that the following items in User Mode are turned on: **LUNCH**, **CAL.RMDR**, and **BP.RMDR** in User Mode, and **ID DISP** and **A.ZERO** in Maintenance Mode. If any of these items are turned off, then the corresponding screens do not appear.

1. Press and briefly hold down POWER MODE. Release the button when you hear a beep.
2. If **LUNCH** is set to **ON** (factory setting if **OFF**, see page 62), the Lunch Break Screen appears. The unit counts down from 5 seconds.

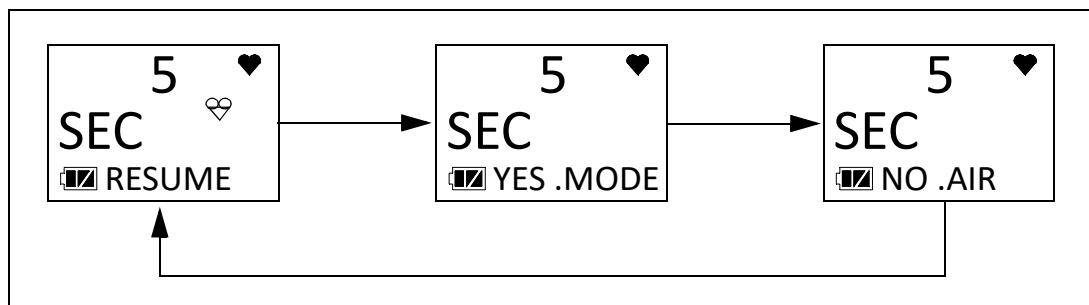

- a. Continue Accumulating: To continue accumulating peak and time-weighted average (TWA) readings from the last time the CO-04 was used, press and release POWER MODE or allow the countdown to reach 0. The short-term exposure limit (STEL) reading is reset each time the CO-04 is turned on.
- b. Reset Accumulation: To reset the accumulation of peak and time-weighted average (TWA) readings, press and release AIR before the countdown reaches 0.

3. If **CAL.RMDR** is set to **ON** (factory setting) and a calibration is due, the screen that appears next depends on how **CAL.EXPD** is set in User Mode (see page 54). The three possible screens are described below. If calibration is not due, the instrument displays the number of days left until a calibration is due.

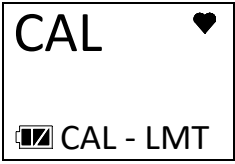
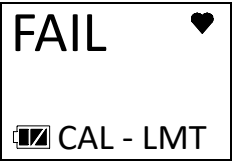
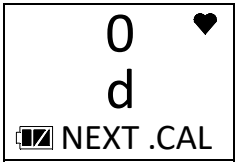
| | CAL.EXPD set to CONFIRM (factory setting) | CAL.EXPD set to CANT.USE | CAL.EXPD set to NONE |
|--------|--|---|--|
| LCD |  |  |  |
| Sound | Buzzer sounds double pulsing tone | Buzzer sounds double pulsing tone | None |
| Action | <ul style="list-style-type: none"> • <u>Option A, Perform calibration</u>: Press and release POWER MODE to enter User Mode and perform a calibration. The instrument takes you straight to the calibration start screen in User Mode's GAS CAL/A-CAL(E-CAL) item (if Password Protection is set to On using the 04 Series Setup Program, you must enter a password first). See page 43 for calibration instructions. If the calibration is successful, the screen above will not appear again until the unit is due for calibration. If the calibration is not successful, the screen above will again appear in the startup sequence. • <u>Option B, Bypass message</u>: To continue without performing a calibration, press and release AIR. | <p>The CO-04 cannot be used until a successful calibration is performed. Press and release POWER MODE to enter User Mode and perform a calibration. The instrument takes you straight to the calibration start screen in User Mode's GAS CAL/A-CAL (E-CAL) item (if Password Protection is set to On using the 04 Series Setup Program, you must enter a password first). If you don't press POWER MODE, the instrument automatically goes to the calibration start screen after 6 seconds (if Password Protection is set to On using the 04 Series Setup Program, you must enter a password first). See page 43 for calibration instructions.</p> <p>If the calibration is successful, the screen above will not appear again until the unit is due for calibration. If the calibration is not successful, the screen above will again appear in the startup sequence.</p> | <ul style="list-style-type: none"> • <u>Option A, Perform calibration</u>: If you want to enter User Mode and perform a calibration, press and release POWER MODE. The instrument takes you straight to the calibration start screen in User Mode's GAS CAL/A-CAL (E-CAL) item (if Password Protection is set to On using the 04 Series Setup Program, you must enter a password first). • <u>Option B, Bypass message</u>: To continue without performing a calibration, wait a few seconds for the instrument to continue with its startup sequence. |

4. If **BP.RMDR** is set to **ON** (factory setting is **OFF**) and a bump test is due, the screen that appears next depends on how **BP.EXPD** is set in User Mode (see page 59). The three possible screens are described below. If a bump test is not due, the instrument displays the number of days left until a bump test is due.

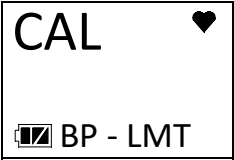
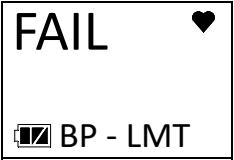
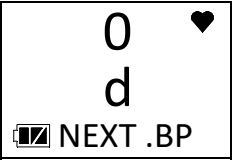
| | BP.EXPD set to CONFIRM (factory setting) | BP.EXPD set to CANT.USE | BP.EXPD set to NONE |
|--------|--|--|---|
| LCD |  |  |  |
| Sound | Buzzer sounds double pulsing tone | Buzzer sounds double pulsing tone | None |
| Action | <ul style="list-style-type: none"> • <u>Option A, Perform bump test:</u> Press and release POWER MODE to enter User Mode and perform a bump test. The instrument takes you straight to the bump test start screen in User Mode's BUMP item (if Password Protection is set to On using the 04 Series Setup Program, you must enter a password first). See page 41 for bump test instructions. If the bump test is successful, the screen above will not appear again until the unit is due for bump testing. If the bump test is not successful, the screen above will again appear in the startup sequence. • <u>Option B, Bypass message:</u> To continue without performing a bump test, press and release AIR. | <p>The CO-04 cannot be used until a successful bump test is performed. Press and release POWER MODE to enter User Mode and perform a bump test. The instrument takes you straight to the bump test start screen in User Mode's BUMP item (if Password Protection is set to On using the 04 Series Setup Program, you must enter a password first). If you don't press POWER MODE, the instrument automatically goes to the bump test start screen after 6 seconds (if Password Protection is set to On using the 04 Series Setup Program, you must enter a password first). See page 41 for bump test instructions.</p> <p>If the bump test is successful, the screen above will not appear again until the unit is due for bump testing. If the bump test is not successful, the screen above will again appear in the startup sequence.</p> | <ul style="list-style-type: none"> • <u>Option A, Perform bump test:</u> If you want to enter User Mode and perform a bump test, press and release POWER MODE. The instrument takes you straight to the bump test start screen in User Mode's BUMP item (if Password Protection is set to On using the 04 Series Setup Program, you must enter a password first). • <u>Option B, Bypass message:</u> To continue without performing a bump test, wait a few seconds for the instrument to continue with its startup sequence. |

- The Date/Time Screen appears for a few seconds.

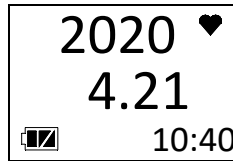

- The Battery Voltage Screen appears for a few seconds. An “AL-L” at the bottom of the screen indicates that the alarms are set to latching. An “AL-A” at the bottom of the screen indicates that the alarms are set to auto reset. See page 86 for a description of how to change this parameter.

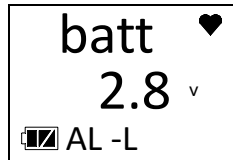

- The following screens display for 1 second each: Gas Name, Full Scale, Warning Setpoint, Alarm Setpoint, Alarm H Setpoint, STEL Setpoint, and TWA Setpoint.

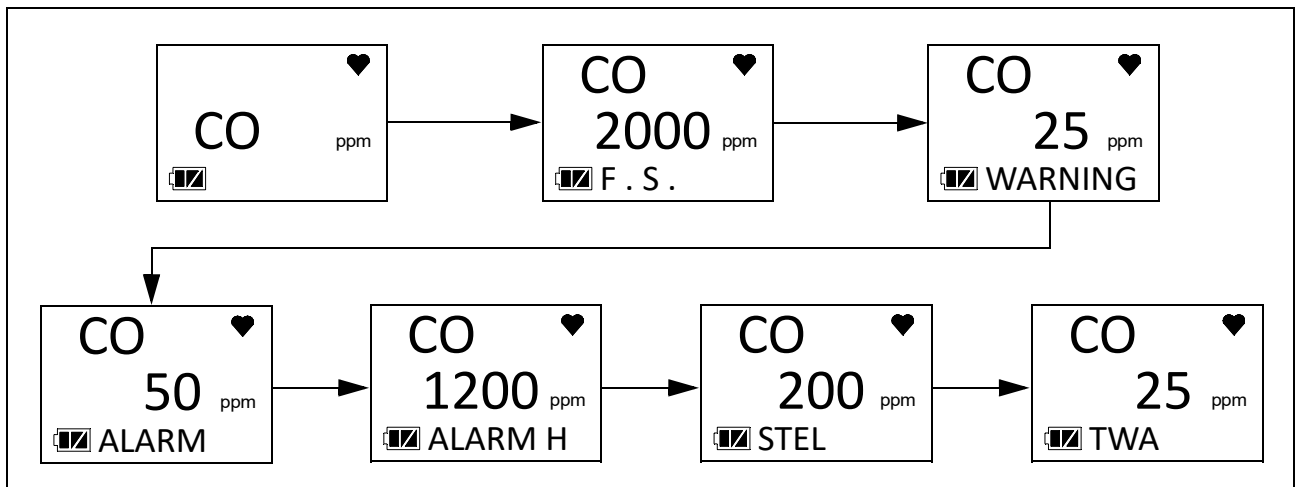

- If **ID DISP** is set to **ON** (factory setting is **OFF**, see page 88), the User ID Screen appears for a few seconds, followed by the Station ID Screen.

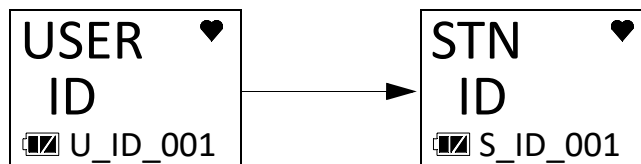

- If the CO-04 experiences a sensor failure during start up, a screen indicating that the sensor failed appears and the buzzer sounds a double pulsing tone once per second.

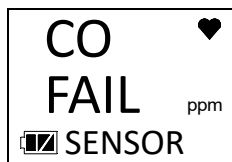

You cannot acknowledge the failure and continue to Measuring Mode. Replace the failed sensor as soon as possible.

10. If **A.ZERO** is set to **ON** (factory setting is **OFF**, see page 87), the instrument prompts you to do an auto zero. An auto zero operation sets the reading to 0 ppm.

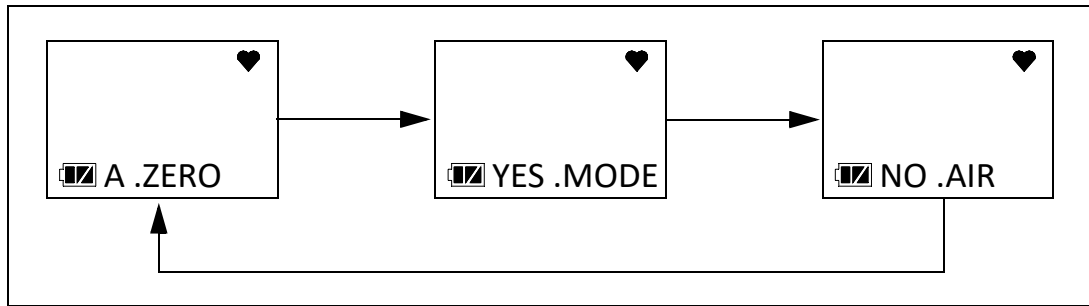

WARNING: *Make sure that the instrument is in a known fresh air environment (an environment free of combustible or toxic gases and of normal oxygen content, 20.9%) before performing an auto zero operation. If you perform an auto zero operation in an area with gases present, the adjustment will not be accurate.*

You must press and release the POWER MODE button to perform an auto zero function. If you do not press any key, after 15 seconds, the instrument enters Measuring Mode without performing an auto zero.

If **Password Protection** is turned **On** (factory setting is **Off**) using the 04 Series Setup Program, a user-set password is required to perform an auto zero. When the password screen appears, adjust each digit with the AIR button and press and release the POWER MODE button to move on to the next digit. Once the password is entered, the instrument performs the auto zero.

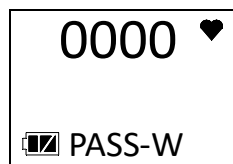

11. The CO-04 is now monitoring for gas in Measuring Mode. The Measuring Mode Screen displays the current gas reading.

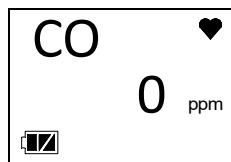

Performing a Demand Zero

Perform a demand zero before using the CO-04. This sets the reading to 0 ppm.

1. Find a fresh-air environment. This is an environment free of toxic or combustible gases and of normal oxygen content (20.9%).
2. Turn on the unit as described above in Turning On the CO-04.
3. Press and hold AIR. The buzzer pulses and the LCD prompts you to continue holding AIR (if **KEY.TONE** is set to **ON** in User Mode).
4. Continue to hold AIR until the LCD prompts you to release it. The CO-04 sets the fresh air reading. Start up is complete and the unit is now ready for monitoring.
5. If **Password Protection** is turned **On** (factory setting is **Off**) using the 04 Series Setup Program, a user-set password is required to perform a demand zero. When the password screen appears, adjust each digit with the AIR button and press and release the POWER MODE button to move on to the next digit. Once the password is entered, the instrument sets the fresh air reading.

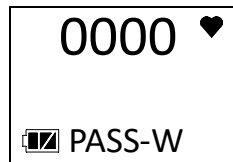

Turning Off the CO-04

1. Press and hold POWER MODE.
2. OFF appears on the display and the buzzer pulses for about five seconds (if **KEY.TONE** is set to **ON** in User Mode).
3. Release the button when OFF disappears from the display.
4. If **Password Protection** is turned **On** (factory setting is **Off**) using the 04 Series Setup Program, a user-set password is required to turn off the CO-04. When the password screen appears, adjust each digit with the AIR button and press and release the POWER MODE button to move on to the next digit. Once the password is entered, the instrument shuts off.

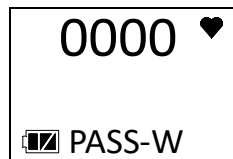

Measuring Mode Operation

When the CO-04 completes its startup sequence, it is in Measuring Mode. In Measuring Mode the CO-04 continuously monitors the sampled atmosphere and displays the gas concentration. The CO-04 is in Normal Operation if there are no alarm indications.

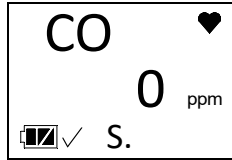

Heart Symbol: The heart symbol in the top right corner of the LCD indicates the operation status and flashes when normal. A microprocessor error causes the heart symbol to stop flashing or to disappear.

Check Mark: If **BP.RMDR** is set to **ON** and if a bump test is not due, a check mark appears in the lower left corner of the LCD.

“S”: If the instrument is operating in Stealth Mode, an “S.” appears at the bottom of the LCD.

Backlight: In a low-light environment, press and release either button to turn on the display backlight. See page 64 to program backlight duration.

Confirmation/Non-Compliance Indicator: If the **BEEP** item in User Mode is set to anything other than **OFF**, the CO-04 gives periodic indications to confirm that it’s operating or to indicate a non-compliance (see page 62).

Monitoring an Area

1. Start up the CO-04 as described above in “Start Up” on page 16. It is now in Measuring Mode.

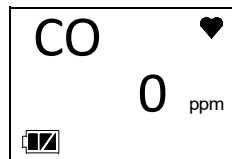

2. The instrument displays the CO reading.
3. Take the CO-04 to the monitoring area.
4. Wait at least 15 seconds.
5. If a reading is observed, allow the reading to stabilize to determine the gas concentration present.
6. If a gas alarm occurs, take appropriate action. See page 25.

Alarms

This section covers alarm indications in Measuring Mode. It also describes how to reset the CO-04 after an alarm occurs and how to respond to an alarm condition.

NOTE: False alarms may be caused by radio frequency (RF) or electromagnetic (EMI) interference. Keep the CO-04 away from RF and EMI sources such as radio transmitters or large motors.

Alarm Indications

The CO-04 buzzer sounds an alarm, the LED flashes, and the vibrator pulses when any sort of alarm condition or failure occurs. If the CO-04 is operating in Stealth Mode, the buzzer does not sound and the vibrator's operation depends on the **VIB** setting in Gas Select Mode's **STEALTH** item. See page 96 for more information.

NOTE: If an alarm condition occurs while you are in Display Mode, the CO-04 automatically returns to the Measuring Mode screen.

The table below summarizes the types of alarms produced by the CO-04 and their indications.

Table 4: Alarm Types and Indications

| Alarm Type | Visual Indications | Other Indications |
|---|---|--|
| <u>Warning</u> Concentration of gas rises above the Warning setting. | <ul style="list-style-type: none">• Gas reading flashes• WARNING appears at the bottom of the LCD• Alarm LED flashes once per second• Backlight turns on | <ul style="list-style-type: none">• High-low tone sounds once per second• Vibrator pulses once per second |
| <u>Alarm</u> Concentration of gas rises above the Alarm setting. | <ul style="list-style-type: none">• Gas reading flashes• ALARM appears at the bottom of the LCD• Alarm LED flashes twice per second• Backlight turns on | <ul style="list-style-type: none">• High-low tone sounds twice per second• Vibrator pulses twice per second |
| <u>Alarm H</u> Concentration of gas rises above the Alarm H setting. | <ul style="list-style-type: none">• Gas reading flashes• ALARM H appears at the bottom of the LCD• Alarm LED flashes twice per second• Backlight turns on | <ul style="list-style-type: none">• High-low tone sounds twice per second• Vibrator pulses twice per second |

Table 4: Alarm Types and Indications

| Alarm Type | Visual Indications | Other Indications |
|--|---|---|
| <u>TWA or STEL</u> Concentration rises above the TWA or STEL alarm setting. | <ul style="list-style-type: none"> Gas reading flashes TWA or STEL appears at the bottom of the LCD Alarm LED flashes once per second Backlight turns on | <ul style="list-style-type: none"> High-low tone sounds once per second Vibrator pulses once per second |
| <u>Over Range</u> | <ul style="list-style-type: none"> Gas reading is replaced with a flashing □□□ Gas name and units flash OVER appears at the bottom of the LCD Alarm LED flashes twice per second Backlight turns on | <ul style="list-style-type: none"> High-low tone sounds twice per second Vibrator pulses twice per second |
| <u>Minus Over Range</u> | <ul style="list-style-type: none"> Affected channel's gas reading is replaced with a flashing "- - -" Gas name and units flash MOVER appears at the bottom of the LCD Alarm LED flashes twice per second Backlight turns on | <ul style="list-style-type: none"> High-low tone sounds twice per second Vibrator pulses twice per second |
| <u>Low Battery Warning</u> | <ul style="list-style-type: none"> The last bar in the battery icon starts flashing | None |
| <u>Dead Battery Alarm</u> | <ul style="list-style-type: none"> Gas reading disappears. FAIL BATTERY appears on the LCD. Alarm LED flashes once per second | Double pulsing tone sounds once per second |
| <u>Sensor Failure</u> | <ul style="list-style-type: none"> FAIL SENSOR appears on the LCD. Alarm LED flashes once per second | Double pulsing tone sounds once per second |
| <u>Clock Failure</u> | <ul style="list-style-type: none"> FAIL 050 CLOCK appears on the LCD Alarm LED flashes once per second | Double pulsing tone sounds once per second |
| <u>System Failure</u> | <ul style="list-style-type: none"> FAIL SYSTEM and an error code appear on the LCD Alarm LED flashes once per second | Double pulsing tone sounds once per second |

Responding to Alarms

This section describes response to gas, over range, battery, sensor failure, clock failure, and system failure alarms.

Responding to Gas Alarms

1. Follow your established procedure for an increasing gas condition.
2. Reset the alarm as necessary or allowed.
 - a. If **LATCH** is set to **ON** (factory setting) in Maintenance Mode, the gas reading must fall below an alarm setting before you can reset the alarm condition using **POWER MODE** or **AIR**.

If **Password Protection** is turned **On** (factory setting is **Off**) using the 04 Series Setup Program, you must press **POWER MODE** and **AIR** at the same time and then enter a user-set password to reset an alarm condition. When the password screen appears, adjust each digit with the **AIR** button and press and release the **POWER MODE** button to move on to the next digit. Once the password is entered, the alarm condition resets.

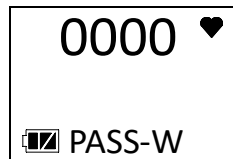

- b. If **LATCH** is set to **OFF** in Maintenance Mode, the alarm condition automatically resets when gas reading falls below an alarm setpoint.

Responding to Over Range Alarms

WARNING: *An over range condition may indicate an extreme carbon monoxide concentration or an explosive concentration. Confirm the gas concentration with a different CO-04 or with another gas detecting device.*

AVERTISSEMENT: *Un dépassement de la plage peut indiquer une concentration extrême en monoxyde de carbone ou une concentration en explosif. Confirmez la concentration de gaz avec un CO-04 différent ou avec un autre dispositif de détection de gaz.*

1. Follow your established procedure for an extreme gas condition.
2. Reset the alarm using **POWER MODE** or **AIR** once the alarm condition clears if **LATCH** is set to **ON** (factory setting) in Maintenance Mode.

If **Password Protection** is turned **On** (factory setting is **Off**) using the 04 Series Setup Program, you must press POWER MODE and AIR at the same time and then enter a user-set password to reset an alarm condition. When the password screen appears, adjust each digit with the AIR button and press and release the POWER MODE button to move on to the next digit. Once the password is entered, the alarm condition resets.

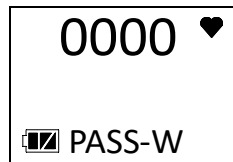

3. Calibrate the CO-04 as described on page 43.
4. If the over range condition continues or if you are not able to successfully calibrate the unit, you may need to replace the sensor.
5. If the over range condition continues after you replace the sensor, contact RKI Instruments, Inc. for further instructions.

Responding to Battery Alarms

WARNING: The CO-04 is not operational as a gas monitoring device during a dead battery alarm. Take the CO-04 to a non-hazardous area and replace the batteries as described in “Replacing the Batteries (Alkaline or Ni-MH)” on page 70.

The CO-04 is fully functional during a low battery warning. However, only a couple of days of operating time remain. The amount of time depends on LCD backlight use and alarm frequency. Replace the batteries as described on page 70 as soon as possible.

NOTE: Alarms and the LCD backlight consume battery power and reduce the amount of operating time remaining.

Responding to Sensor Failure Alarms

1. Calibrate the sensor as described on page 43.
2. If the sensor failure continues, replace the sensor as described on page 77.
3. If the sensor failure condition continues after replacing the sensor, contact RKI Instruments, Inc. for further instructions.

Responding to Clock Failure Alarms

A clock failure alarm occurs if the unit's internal clock malfunctions.



1. Press and release POWER MODE to continue into Measuring Mode.

CAUTION: *There is no datalogging function if you operate the instrument after a clock failure.*

2. Attempt to set the date using the **DATE** item in User Mode (see page 66).
3. If the date cannot be set correctly, contact RKI Instruments, Inc. as soon as possible.

Responding to System Failure Alarms

1. If a system failure occurs, the system failure screen displays an error code as shown below:



2. The error code meanings are shown in the table below:

Table 5: Error Code Explanation

| Error Code | Explanation |
|-------------------|----------------------------|
| 000 | ROM failure |
| 010 | RAM failure |
| 020 | FRAM failure |
| 031 | FLASH memory failure |
| 082 | Temperature sensor failure |

3. If the error code is anything but 031, the instrument cannot be used. Contact RKI Instruments, Inc. as soon as possible.

If the error code is 031, press and release POWER MODE to continue into Measuring Mode if the instrument must be used temporarily.

CAUTION: *There is no datalogging function if you operate the instrument after a 031 system failure. Contact RKI Instruments, Inc. as soon as possible.*

Data Logging

The CO-04 logs Measuring Mode gas readings, alarm data, and calibration data to its internal memory. Logged data can be download it to a computer via the infrared communications port on the front of the unit.

The data logging capacity depends on how often the CO-04 stores data and how often the CO-04 is turned on and off. The table below illustrates how much data logging time is available for the various interval times. It assumes that the unit is only turned on once and there are no alarms. The data logging interval time must be set using the 04 Series Datalogging Program.

Table 6: Data Logging Capacity

| Interval Time | Data Logging Capacity |
|----------------------|------------------------------|
| 10 seconds | 10 hours |
| 20 seconds | 20 hours |
| 30 seconds | 30 hours |
| 1 minute | 60 hours |
| 3 minutes | 180 hours |
| 5 minutes | 300 hours |
| 10 minutes | 600 hours |

To utilize the CO-04's downloading capability, you need:

- PC with Windows 7, Windows 8, Windows 10, or Windows 11
- IrDA port or IrDA/USB cable (cable available from RKI Instruments, Inc.)
- 04 Series Datalogging Program (available at www.rkiinstruments.com/04series).

For a complete description of the Datalogging Program and procedures for downloading data to a computer, see the 04 Series Datalogging Program Operator's Manual.

Chapter 4: Display Mode

This section describes Display Mode which is accessible from Measuring Mode. See Table 7 below for a list of Display Mode's menu items, a short description of each item, and the page number for further description.

Table 7: Display Mode Menu Items

| Display Mode Menu Item | Description |
|---|--|
| PEAK (page 30) | Displays the Peak reading. |
| STEL (page 30) | Displays the STEL reading. |
| TWA (page 31) | Displays the TWA reading. |
| USER ID (page 31) ^A | View and/or change the User ID. |
| STN ID (page 32) ^A | View and/or change the Station ID. |
| CAL.DATA (page 32) ^B | Displays the last calibration date. |
| BP.DATA (page 33) ^C | Displays the last bump test date. |
| DATE (page 33) | Displays the current date and time. |
| TEMP (page 34) | Displays the current temperature. |
| ALARM--P (page 34) | View alarm points. |
| BUZZ.VOL (page 35) ^D | Set the buzzer volume to LO or HI (factory setting). |
| <p>^A Only appears if DISP.SET is set to ON in User Mode (factory setting) <u>and</u> if ID DISP is set to ON in Maintenance Mode (factory setting is OFF).</p> <p>^B Only appears if CAL.RMDR is set to ON in User Mode (factory setting).</p> <p>^C Only appears if BP.RMDR is set to ON in User Mode (factory setting is OFF).</p> <p>^D Only appears if DISP.SET is set to ON in User Mode (factory setting).</p> | |

Tips for Using Display Mode

- To enter Display Mode and scroll from one item to the next or skip an item when a question is asked, press and release POWER MODE.
- To enter an item, press and release AIR.
- To change a flashing parameter, press and release AIR. To reverse the movement in a list (ie. from down to up or vice versa):
 - a. Press and hold AIR.
 - b. Immediately press POWER MODE and then release both buttons.

- To exit from an entered-information screen and go back to Measuring Mode, press and release POWER MODE until you get to the Measuring Mode screen.

NOTE: Each screen displays for 20 seconds. If you do not press a button within 20 seconds, the CO-04 automatically returns to Measuring Mode.

Peak Screen (PEAK)

The peak screen displays the highest concentration detected since the CO-04 was turned on. The peak reading is stored until a higher level is detected, the peak reading is cleared, or the CO-04 is turned off.

The lunch break feature enables the CO-04 to save the peak reading when it is turned off so it can continue with the same peak when it is turned on again (see page 16).

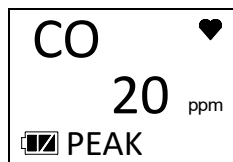

To clear the peak reading, do the following:

NOTE: If **Password Protection** is set to **On** using the 04 Series Setup Program, the peak reading cannot be cleared.

1. After entering Display Mode, press and release POWER MODE until **PEAK** appears.
2. Press and hold AIR until the screen prompts you to release it.

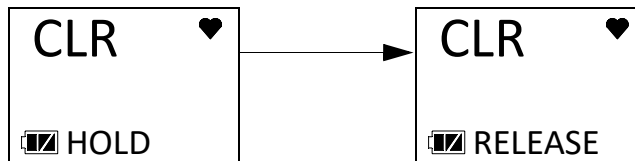

3. The peak reading is reset and the unit returns to the Peak Screen.

If you do not want to clear the peak reading, release AIR before the above screen sequence occurs. The unit returns to the Peak Screen.

STEL Screen (STEL)

The STEL Screen displays the short term exposure limit (STEL) reading. The STEL reading is the average reading *over the last 15 minutes*.

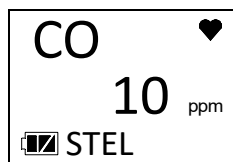

TWA Screen (TWA)

The TWA Screen displays the time weighted average (TWA) reading.

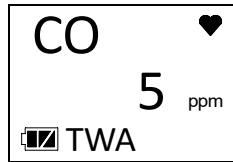

The TWA reading is the average reading *over the last 8 hours*. If 8 hours have not elapsed since the last time the TWA reading was cleared, the average is still calculated over 8 hours. The missing readings are assigned a value of 0. If **LUNCH** is set to **OFF** (factory setting), the TWA is cleared when the CO-04 is turned off.

If **LUNCH** is set to **ON**, the CO-04 remembers the TWA reading when it is turned off and can continue accumulation when it is turned on again (see page 16).

Changing the User ID (USER ID)

This screen only appears if **DISP.SET** in User Mode is set to **ON** (factory setting) and if **ID DISP** in Maintenance Mode is set to **ON** (factory setting is **OFF**).

Use this screen to select a user ID from the 128 user IDs that are stored in the CO-04's memory. Before a user ID is selected on a brand new instrument, the user ID is "-----". The factory-installed user IDs have a "U_ID_XXX" format.

The user ID provides a way to identify the CO-04 user during a data logging session.

User IDs can only be selected in this menu item. In order to edit the 128 user IDs, you must use the 04 Series Datalogging Program or 04 Series Setup Program.

1. After entering Display Mode, press and release POWER MODE until the **USER ID** screen sequence appears.

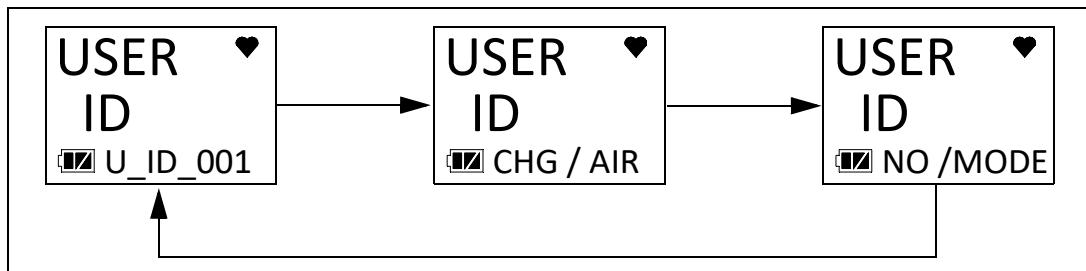

2. To change the User ID, press and release AIR. The current User ID flashes.

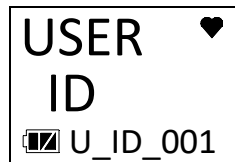

3. Use AIR to scroll to the desired User ID.
4. Press and release POWER MODE to save the User ID and return to the **USER ID** screen in Display Mode.

Changing the Station ID (STN ID)

This screen only appears if **DISP.SET** in User Mode is set to **ON** (factory setting) and if **ID DISP** in Maintenance Mode is set to **ON** (factory setting is **OFF**).

Use this screen to select a station ID from the 128 station IDs that are stored in the CO-04's memory. Before a station ID is selected on a brand new instrument, the station ID is "-----". The factory-installed station IDs have a "S_ID_XXX" format.

The station ID provides a way to identify the CO-04 location during a data logging session.

User IDs can only be selected in this menu item. In order to edit the 128 user IDs, you must use the 04 Series Datalogging Program or 04 Series Setup Program.

1. After entering Display Mode, press and release **POWER MODE** until the **STN ID** screen sequence appears.

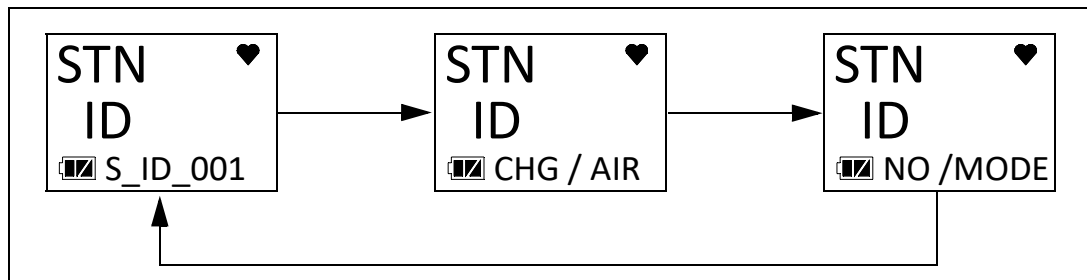

2. To change the Station ID, press and release **AIR**. The current Station ID flashes.

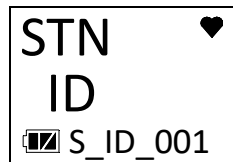

3. Use **AIR** to scroll to the desired Station ID.
4. Press and release **POWER MODE** to save the Station ID and return to the **STN ID** screen in Display Mode.

Last Successful Calibration Date (CAL.DATA)

The **CAL.DATA** screen shows the date of the last successful calibration. This screen only appears if **CAL.RMDR** is set to **ON** (factory setting).

1. After entering Display Mode, press and release **POWER MODE** until the **CAL.DATA** screen sequence appears.

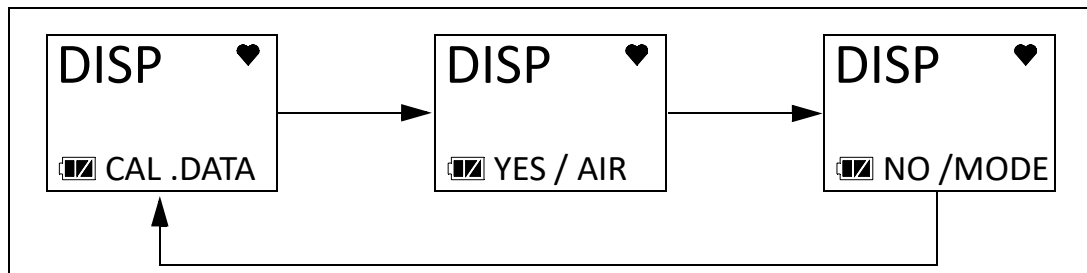

2. Press AIR to enter the **CAL.DATA** screen. The date of the last successful calibration displays.

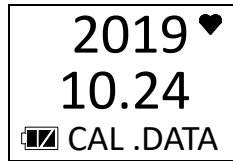

3. Press and release POWER MODE to return to the **CAL.DATA** screen in Display Mode.

Last Successful Bump Test Date (BP.DATA)

The **BP.DATA** screen shows the date of the last successful bump test. This screen only appears if **BP.RMDR** is set to **ON** (factory setting is **OFF**).

1. After entering Display Mode, press and release POWER MODE until the **BP.DATA** screen sequence appears.

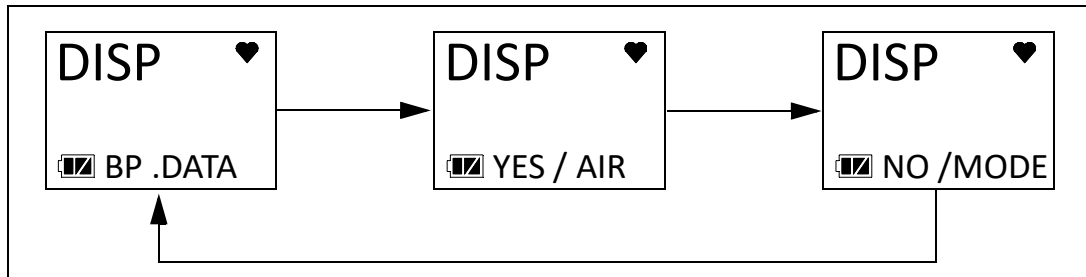

2. Press AIR to enter the **BP.DATA** screen. The date of the last successful bump test displays.

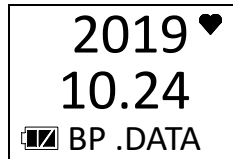

3. When you are done viewing the last bump test date, press and release POWER MODE to return to the **BP.DATA** screen in Display Mode.

Date/Time Screen (DATE)

The **DATE** screen shows the instrument's date and time.

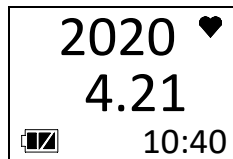

Temperature Screen (TEMP)

The **TEMP** screen shows the surrounding area's temperature.

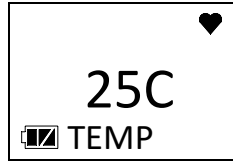

Alarm Points Screen (ALARM--P)

The Alarm Points Screen shows the gas alarm settings.

1. After entering Display Mode, press and release **POWER MODE** until the **ALARM--P** screen sequence appears.

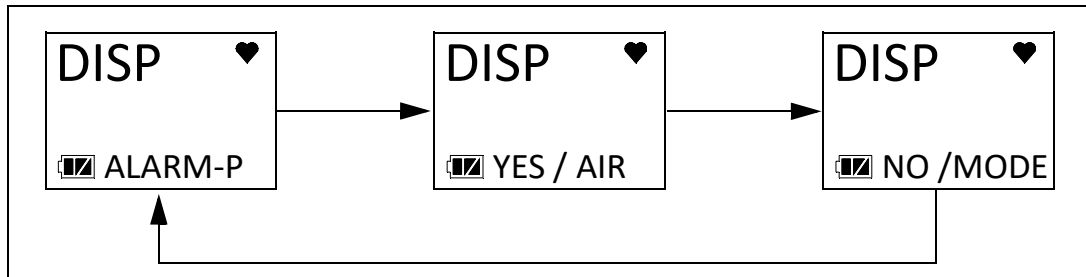

2. Press and release **AIR**. The Full Scale Setting screen appears.
3. Use **AIR** to scroll through the Warning, Alarm, Alarm H, STEL, and TWA settings.

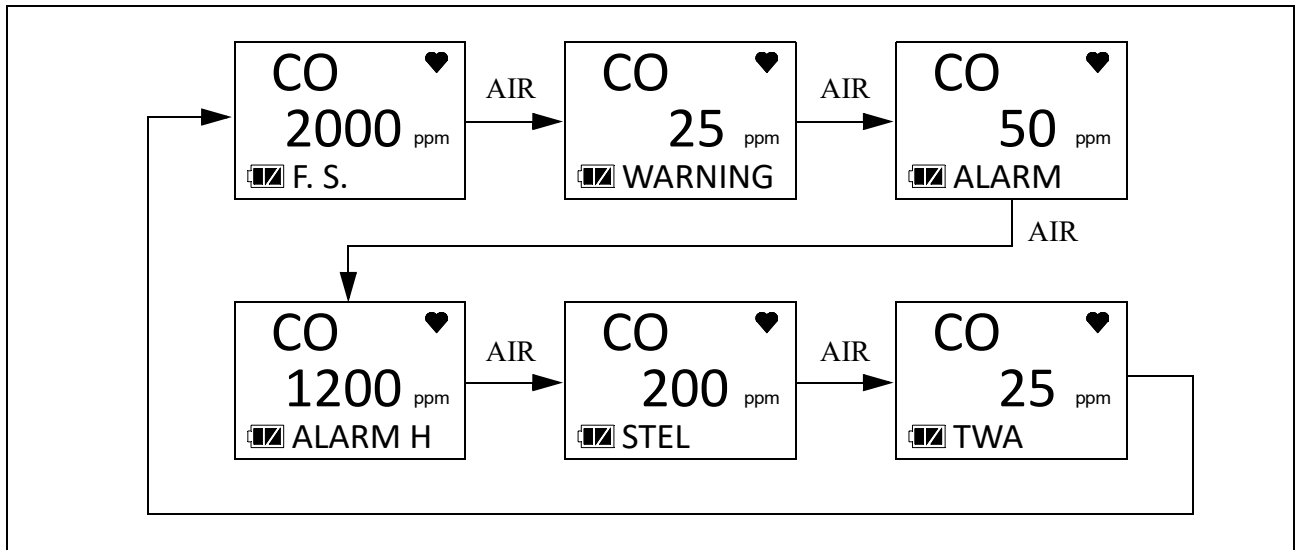

4. While viewing the alarm settings for a particular alarm point, press and release **AIR** and **POWER MODE** at the same time to simulate the alarm conditions. The buzzer will sound, the LED will flash, and the instrument will vibrate just as it would if the displayed condition was actually happening.

5. Press and release POWER MODE to return to the Alarm Points Screen.

Adjusting the Buzzer Volume (BUZZ.VOL)

The **BUZZ.VOL** screen allows you to adjust the volume of the instrument's buzzer. This screen only appears if **DISP.SET** in User Mode is set to **ON** (factory setting).

HI (factory setting): Buzzer volume is high.

LO: Buzzer volume is low.

1. While in Display Mode, press and release POWER MODE until **BUZZ.VOL** appears. The current setting displays on the top line.

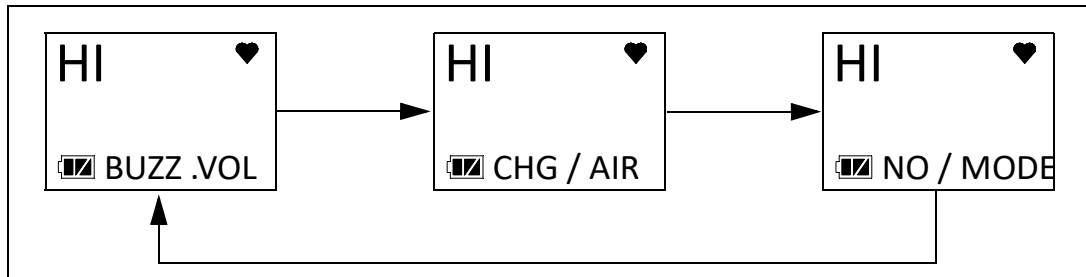

2. Press and release AIR. The current setting flashes.
3. Use AIR to display the desired setting.
4. Press and release POWER MODE to save the setting and return to the **BUZZ.VOL** item in Display Mode.

Chapter 5: User Mode and Calibration

Overview

This section describes the CO-04 in User Mode. See Table 8 below for a list of the items found in User Mode, the page that the item's instructions can be found on, and a short description of the item.

Table 8: User Mode Menu Items

| User Mode Menu Item | Description | | | |
|---------------------|--|---|---|--|
| BUMP (page 41) | Perform a bump test. | | | |
| | BUMP | Perform a bump test. | | |
| | START | Begin the warmup sequence and enter Measuring Mode. | | |
| | ESCAPE | Return to the BUMP menu item. | | |
| GAS CAL (page 43) | Perform a fresh air adjustment, perform a span adjustment, change the calibration gas concentration. | | | |
| | AIR (page 45) | Perform a fresh air adjustment. | | |
| | A-CAL (page 46) or E-CAL (page 49) depending on E-CAL User Mode setting | A-CAL (or E-CAL) | Perform a span adjustment. | |
| | | START | Begin the warmup sequence and enter Measuring Mode. | |
| | | CAL-P | Set the calibration gas concentration. | |
| | ESCAPE | Return to the A-CAL item in the GAS CAL menu. | | |
| ESCAPE | Return to the GAS CAL item in User Mode. | | | |
| CAL SET (page 53) | Change parameters related to calibration. | | | |
| | CAL.RMDR (page 54) | <p>ON (factory setting): The instrument notifies the user upon startup when a calibration is due. Notification type depends on CAL.EXPD setting below. CAL.DATA screen appears in Display Mode.</p> <p>OFF: No notification upon startup when a calibration is due. CAL.DATA screen does not appear in Display Mode.</p> | | |

Table 8: User Mode Menu Items

| User Mode Menu Item | Description | | |
|----------------------------|--|---|---|
| CAL SET (page 53) cont. | CAL.INT (page 54) | How often the instrument needs to be calibrated. Options: 1 - 1000 days (factory setting is 90 days) | |
| | CAL.EXPD (page 54) | Defines what action must be taken if a calibration is due upon startup. CONFIRM (factory setting) : Press and release AIR to acknowledge that calibration is due and continue to Measuring Mode. CANT.USE : Cannot enter Measuring Mode until a successful calibration is performed. NONE : A screen indicates that calibration is due but warmup sequence continues. | |
| | ESCAPE | Return to the CAL SET item in User Mode. | |
| BUMP.SET (page 55) | Change parameters related to bump testing. | | |
| | SETTING (page 56) | GAS.TIME | How long gas is applied during a bump test. Choices: 30 (factory setting), 45, 60, 90 seconds |
| | | CHECK | Percentage of calibration gas concentration that the bump test reading must be within in order to pass bump. Options: 10%, 20%, 30%, 40%, 50% (factory setting) |
| | | CAL.TIME | How long gas is applied during a calibration. GAS.TIME is deducted from this time. Options: 90 (factory setting) or 120 seconds |
| | | A-CAL | ON (factory setting) : If a bump test fails, a calibration automatically starts. OFF : If a bump test fails, a calibration does not automatically start. |
| | | ESCAPE | Return to the SETTING item in the BUMP SET menu. |
| | BP.RMDR (page 58) | ON : The instrument notifies the user upon startup when a bump test is due. Notification type depends on BP.EXPD setting below. BP.DATA screen appears in Display Mode. OFF (factory setting) : No notification upon startup when a bump test is due. BP.DATA screen does not appear in Display Mode. | |
| BP.INT (page 58) | How often the instrument needs to be bump tested. Options: 0 - 30 days (factory setting is 30 days) | | |

Table 8: User Mode Menu Items

| User Mode Menu Item | Description | |
|-----------------------------|--|--|
| BUMP.SET (page 55) cont. | BP.EXPD (page 59) | <p>Defines what action must be taken if a bump test is due upon startup.</p> <p>CONFIRM (factory setting): Press and release AIR to acknowledge that bump test is due and continue to Measuring Mode.</p> <p>CANT.USE: Cannot enter Measuring Mode until a successful bump test is performed.</p> <p>NONE: A screen indicates that bump test is due but warmup sequence continues.</p> |
| | ESCAPE | Return to the BUMP SET item in User Mode. |
| ALARM-P (page 60) | Set alarm points (WARNING, ALARM, ALARM H, STEL, TWA) and/or reset all alarms to their default settings. | |
| LUNCH (page 62) | <p>ON: Lunch break feature is on. Instrument asks if you want to resume TWA and PEAK readings at startup.</p> <p>OFF (factory setting): Lunch break feature is off. Instrument resets TWA and PEAK readings every time it's turned on.</p> | |
| BEEP (page 62) | Set confirmation beep parameters. | |
| | BEEP.SEL (page 63) | <p>LED: LED flashes and instrument vibrates based on interval defined in BEEP.INT to confirm instrument is still operating.</p> <p>BUZZER: Buzzer sounds and instrument vibrates based on interval defined in BEEP.INT to confirm instrument is still operating.</p> <p>LED+BUZ: LED flashes, buzzer sounds, and instrument vibrates based on interval defined in BEEP.INT to confirm instrument is still operating.</p> <p>BMP/CAL: LED flashes based on interval defined in BEEP.INT if bump test or calibration is due regardless of whether BP.RMDR and/or CAL.RMDR are set to ON.</p> <p>OFF (factory setting): No alerts to confirm instrument is still operating or that a bump test or calibration is due.</p> |
| | BEEP.INT (page 63) | <p>Confirmation alert interval. Confirmation type defined in BEEP.SEL.</p> <p>Options: 0.5 minute and 1 to 99 minutes in 1 minute increments. The factory setting is 5 minutes.</p> |
| | ESCAPE | Return to the BEEP item in User Mode. |
| BL TIME (page 64) | <p>How long the back light stays on after the last button press.</p> <p>Options: 0 - 255 seconds or OFF. The factory setting is 30 seconds.</p> | |
| KEY.TONE (page 64) | <p>ON (factory setting): Buzzer sounds when button is pressed.</p> <p>OFF: Buzzer does not sound when button is pressed.</p> | |

Table 8: User Mode Menu Items

| User Mode Menu Item | Description |
|---|---|
| DISP.SET (page 65) | OFF: USER ID , STN ID , and BUZZ.VOL items do not appear in Display Mode. ON (factory setting): BUZZ.VOL item appears in Display Mode. USER ID and STN ID items appear if ID DISP in Maintenance Mode is also set to ON . |
| ZERO.SUP (page 65)* | ON (factory setting): Not intended for field adjustment. The suppression value is 2 ppm. |
| ZERO.FLW (page 65)** | ON (factory setting): Not intended for field adjustment. |
| E-CAL (page 66) | XX seconds: E-CAL appears in GAS CAL instead of A-CAL . OFF (factory setting): E-CAL does not appear in GAS CAL . |
| DATE (page 66) | Set the instrument's date and time. |
| PASS-W (page 67) | ON: User Mode is password-protected. Factory-set password is 0405 . OFF (factory setting): User Mode is not password-protected. |
| ROM/SUM (page 68) | View the firmware information for the CO-04's sensor board and main board. |
| START (page 68) | Press and release POWER MODE to begin the warmup sequence and enter Measuring Mode. |
| * Only appears if ZSUP.DSP is set to ON in Maintenance Mode. ** Only appears if ZFLW.DSP is set to ON in Maintenance Mode. | |

Entering User Mode

WARNING: *The CO-04 is not in operation as a gas detector while in User Mode.*

1. Take the CO-04 to a non-hazardous location and turn it off if it is on.
2. Press and hold **AIR**, then press and hold **POWER MODE**. When you hear a beep, release the buttons.
3. The screen that appears depends on the setting of User Mode's **PASS-W** item.

If **PASS-W** is set to **OFF** (factory setting), continue with Step 6.

If **PASS-W** is set to **ON**, continue with Step 4.

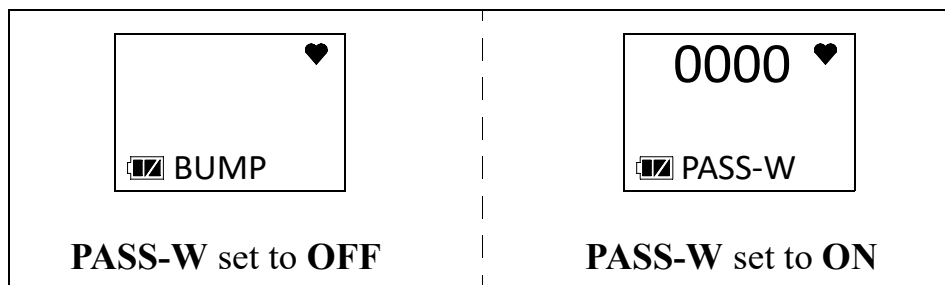

4. If **PASS-W** is set to **ON** in User Mode, a password screen appears and the first digit flashes. The factory-set password is **0405** but it can be changed.
5. Use AIR to select each password number then press POWER MODE to save it and move on to the next number. To go back a number, press and hold AIR and POWER MODE for a few seconds. To reverse the direction of change (ie. from increasing to decreasing or vice versa):
 - a. Press and hold AIR.
 - b. Immediately press POWER MODE and then release both buttons.
6. The **BUMP** item displays.



7. Use AIR to move through the User Mode items.

Tips for Using User Mode

- To scroll from one item to the next, press and release AIR. To reverse the scrolling direction:
 - a. Press and hold AIR.
 - b. Immediately press POWER MODE and then release both buttons.
 - c. The scrolling direction returns to the original direction when you exit and reenter a menu.
- To skip an item when a question is asked, press and release AIR.
- To enter an item and to save any changes, press and release POWER MODE.
- To change a flashing parameter, press and release AIR. To reverse the direction of change (ie. from increasing to decreasing or vice versa):
 - a. Press and hold AIR.
 - b. Immediately press POWER MODE and then release both buttons.
- To exit an entered item without saving a change, press and hold AIR and POWER MODE for a few seconds.

Performing a Bump Test (BUMP)

Bump test the instrument before each day's use with a known concentration of the target gas. The instrument does not need to be calibrated unless it does not pass the bump test.

To bump test the CO-04, you need:

- Calibration gas cylinder (RKI Instruments recommends using 50 ppm CO but any value between 15 ppm and 2,000 ppm can be used)
 - 0.25 LPM fixed flow regulator
 - Non-absorbent tubing
 - Calibration cup
1. Confirm that the CO-04's calibration gas value matches the concentration listed on the calibration gas cylinder as described on page 52.
 2. Confirm that the regulator knob is turned all the way clockwise. Screw the 0.25 LPM fixed flow regulator onto the calibration cylinder.
 3. Install the calibration cup onto the CO-04. Be sure the calibration cup is installed in the correct direction and that it is pushed on all the way.

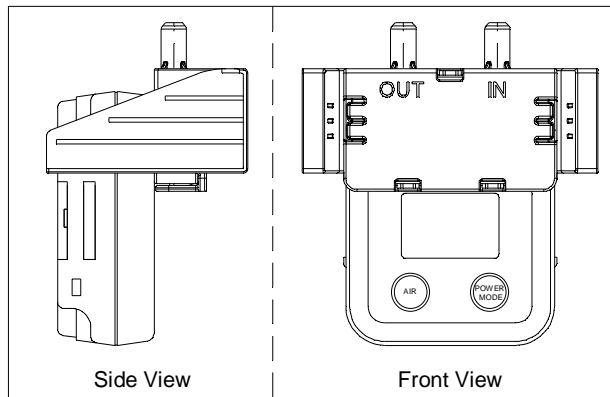

4. Use the tubing to connect the regulator to the inlet of the calibration cup (labeled "IN").
5. While in User Mode, press AIR to scroll to **BUMP**.

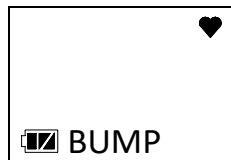

6. Press and release POWER MODE. The display shows the calibration value (see page 52 if the calibration value does not match the calibration gas cylinder's concentration).

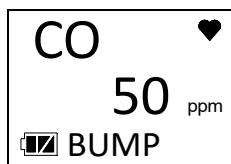

7. Turn the regulator knob counterclockwise to open the regulator.

8. Press and release POWER MODE.
9. The gas reading flashes, the bottom of the screen alternates between “APLY” and “BUMP”, and the bottom of the screen counts down from the time set in **BUMP.SET\SETTING\GAS.TIME**.

To back out of the gas application screen without performing the bump test, press and release AIR and POWER MODE together.

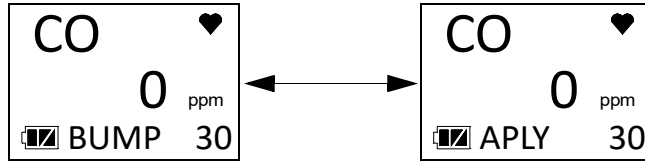

10. At the end of the countdown, the instrument analyzes the results. Follow the flow chart to determine the bump test outcome.

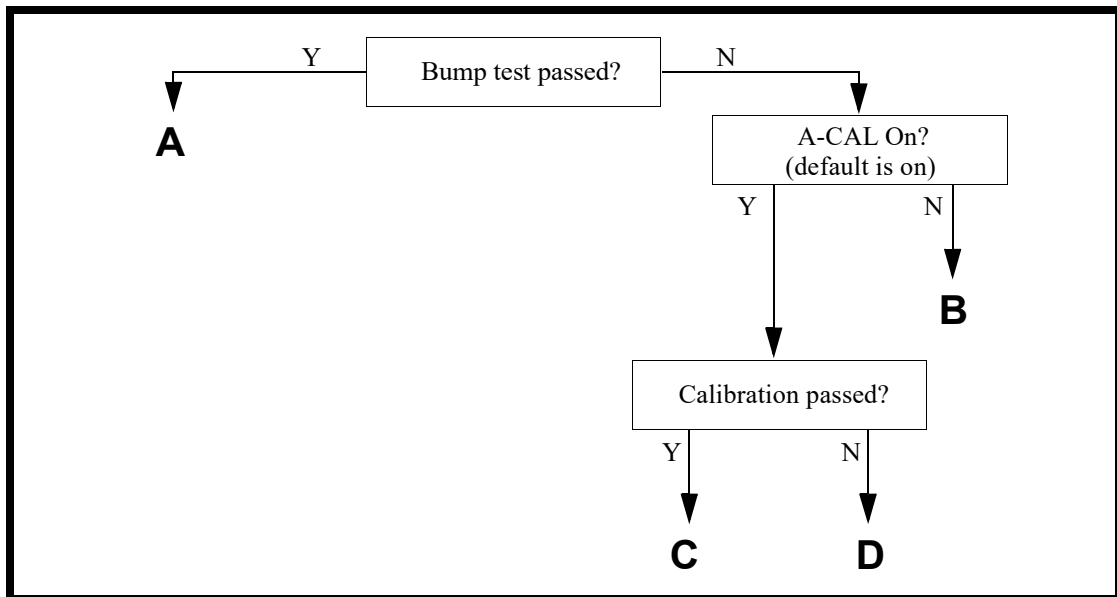
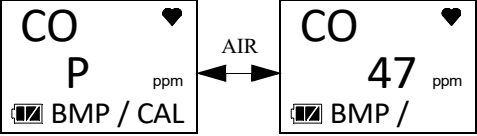
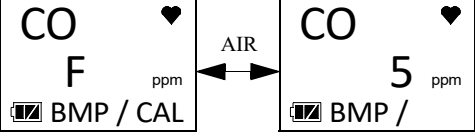
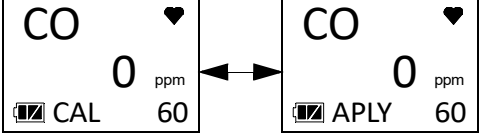
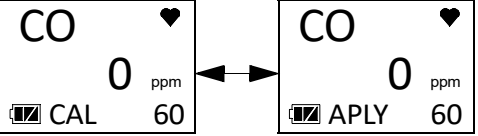
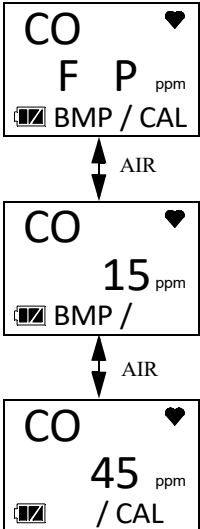
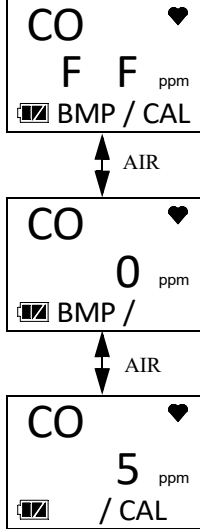

Figure 6: Bump Test Flow Chart

| Option A from Flow Chart | Option B from Flow Chart |
|--|---|
| <ul style="list-style-type: none"> • Bump test passed | <ul style="list-style-type: none"> • Bump test failed • A-CAL set to OFF (factory setting is ON) |
| <ol style="list-style-type: none"> 1. The instrument indicates that the channel passed the bump test. Use AIR to scroll between the bump test result and the bump test gas reading. | <ol style="list-style-type: none"> 1. The instrument shows if the channel passed or failed the bump test. The LED flashes and the buzzer sounds. Use AIR to scroll between the result and the reading. |
|  |  |
| <ol style="list-style-type: none"> 2. Close the regulator. 3. Unscrew the regulator. 4. Remove the calibration cup. 5. Press and release POWER MODE to return to the BUMP screen in the BUMP menu. 6. Use AIR to scroll to START and press and release POWER MODE to enter Measuring Mode. | <ol style="list-style-type: none"> 2. Close the regulator. 3. Unscrew the regulator. 4. Remove the calibration cup. 5. Press and release POWER MODE to return to the BUMP screen in the BUMP menu. 6. Use AIR to scroll to START and press and release POWER MODE to enter Measuring Mode. 7. Calibrate the CO-04 as soon as possible. |

| Option C from Flow Chart | Option D from Flow Chart |
|---|---|
| <ul style="list-style-type: none"> • Bump test failed • A-CAL set to ON (factory setting) • Calibration passed | <ul style="list-style-type: none"> • Bump test failed • A-CAL set to ON (factory setting) • Calibration failed |
| <ol style="list-style-type: none"> 1. A calibration immediately and automatically starts. Continue to apply the calibration gas. 2. The calibration time is the difference between the GAS.TIME and the CAL.TIME values defined in the BUMP.SET\SETTING item in User Mode. | <ol style="list-style-type: none"> 1. A calibration immediately and automatically starts. Continue to apply the calibration gas. 2. The calibration time is the difference between the GAS.TIME and the CAL.TIME values defined in the BUMP.SET\SETTING item in User Mode. |
|  |  |
| <ol style="list-style-type: none"> 3. The instrument shows the pass/fail results of the bump test/calibration. Use AIR to scroll between the results and the readings. | <ol style="list-style-type: none"> 3. The instrument shows the pass/fail results of the bump test/calibration. The LED flashes and the buzzer sounds. Use AIR to scroll between the results and the readings. |
|  |  |
| <ol style="list-style-type: none"> 4. Close the regulator. 5. Unscrew the regulator. 6. Remove the calibration cup. 7. Press and release POWER MODE to return to the BUMP CYL A screen in the BUMP menu. 8. Use AIR to scroll to START and press and release POWER MODE to enter Measuring Mode. | <ol style="list-style-type: none"> 4. Close the regulator. 5. Unscrew the regulator. 6. Remove the calibration cup. 7. Press and release POWER MODE to return to the BUMP CYL A screen in the BUMP menu. 8. Use AIR to scroll to START and press and release POWER MODE to enter Measuring Mode. |

Performing a Calibration (GAS CAL)

- Bump test the instrument before each day's use with a known concentration of the target gas. A bump test can be done in User Mode's **BUMP** item or by applying gas in Measuring Mode. The instrument does not need to be calibrated unless it does not pass the User Mode bump test or does not respond appropriately, as defined by the user, in Measuring Mode.
- To fully calibrate the sensors, you must do a fresh air adjustment (**AIR CAL**) and a span adjustment (**A-CAL** or **E-CAL**).
- The CO-04 can be calibrated using either **A-CAL** or **E-CAL** depending on the setting of the **E-CAL** User Mode item.
 - **A-CAL** (appears if **E-CAL** User Mode item is set to **OFF**): Apply gas for a period of time, then press and release **POWER MODE** to perform the adjustment.
 - **E-CAL** (appears if **E-CAL** User Mode item is set to something besides **OFF**): As soon as gas is applied and the reading reaches 10% of the auto calibration value, the instrument counts down from the number of seconds specified in the **E-CAL** User Mode item and automatically performs the adjustment.

Performing a Fresh Air Adjustment (AIR)

1. Find a fresh air environment, an environment of normal oxygen content (20.9%) that is free of toxic and combustible gases.
2. While in User Mode, press **AIR** to scroll to **GAS CAL**.



3. Press and release **POWER MODE**. The **AIR** item appears.



4. Press and release **POWER MODE** to enter the **AIR** menu.

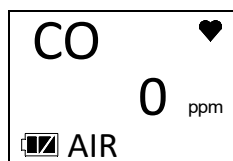

5. To return to the **AIR** menu without performing a fresh air adjustment, press and release **POWER MODE**.

6. Press and hold **AIR** until the screen prompts you to release it.

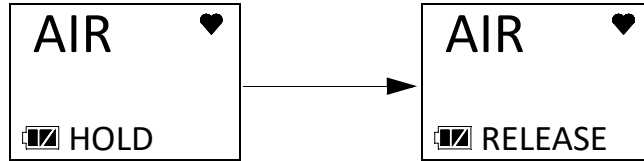

7. If the fresh air adjustment passes, the instrument returns to the **AIR** item in the **GAS CAL** menu.
8. If the fresh air adjustment fails, “FAIL AIR” displays. Press and release **POWER MODE** to acknowledge the failure. See page 69.

Performing a Span Adjustment in A-CAL

The **A-CAL** item only appears if **E-CAL** in User Mode is set to **OFF** (factory setting). If **E-CAL** is set to **ON**, see page 49 for calibration instructions.

Preparing for Span Adjustment

To adjust the span on the CO-04, you need:

- Calibration gas cylinder
- 0.25 LPM fixed flow regulator

Table 9: Calibration Limits

| Channel | Min. Cal. Concentration | Max. Cal Concentration |
|-----------------|--------------------------------|-------------------------------|
| Carbon Monoxide | 15 ppm | 2,000 ppm |

- Non-absorbent tubing
 - Calibration cup
1. Confirm that the CO-04’s calibration gas value matches the concentration listed on the calibration gas cylinder as described on page 52.
 2. Confirm that the regulator knob is turned all the way clockwise. Screw the 0.25 LPM fixed flow regulator onto the calibration cylinder.

3. Install the calibration cup onto the CO-04. Be sure the calibration cup is installed in the correct direction and that it is pushed on all the way.

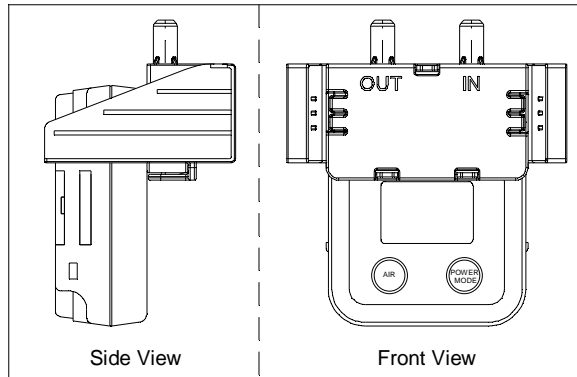

4. Use the tubing to connect the regulator to the inlet of the calibration cup (labeled “IN”).

Performing a Span Adjustment

1. While in User Mode, press AIR to scroll to **GAS CAL**.



2. Press and release POWER MODE. The **AIR** item appears.
3. Use AIR to scroll to the **A-CAL** item.



4. Press and release POWER MODE. The display shows the assigned calibration value (see page 52 if the calibration value does not match the calibration gas cylinder’s concentration).

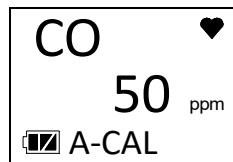

5. Press and release POWER MODE.
6. The gas reading flashes and the bottom of the screen alternates between “APPLY” and “A-CAL”.

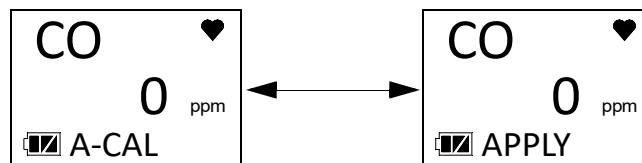

NOTE: To back out of the gas application screen without performing the calibration, press and release AIR and POWER MODE together.

7. Turn the regulator knob counterclockwise to open the regulator.
8. Allow the gas to flow for 1 minute.
9. Press and release POWER MODE.
10. The table below describes the 2 calibration outcomes.

| Calibration Passed | Calibration Failed |
|--|---|
| <p>1. The instrument indicates that the calibration passed.</p> <div data-bbox="462 499 659 634" style="border: 1px solid black; padding: 5px; text-align: center;"> <p>PASS ♥</p> <p>▣ A-CAL</p> </div> <p>2. The instrument shows the current gas reading.</p> <div data-bbox="462 718 659 852" style="border: 1px solid black; padding: 5px; text-align: center;"> <p>CO ♥</p> <p>51 ppm</p> <p>▣ A-CAL</p> </div> <p>3. If MAX.SPAN is set to ON (default is OFF, see page 95), the response reading's maximum adjustment is displayed. A maximum span of 100 ppm indicates that the reading could have been adjusted up to 100 ppm. If the maximum span value is close to the calibration gas value, the sensor should be replaced soon. The maximum adjustment is either twice the calibration value or full scale, whichever is lower.</p> <div data-bbox="462 1251 659 1386" style="border: 1px solid black; padding: 5px; text-align: center;"> <p>CO ♥</p> <p>91 ppm</p> <p>▣ MAX .SPAN</p> </div> <p>4. Close the regulator.</p> <p>5. Remove the calibration cup.</p> <p>6. Press and release POWER MODE to enter Measuring Mode.</p> | <p>1. The instrument indicates that the calibration failed.</p> <div data-bbox="950 499 1146 634" style="border: 1px solid black; padding: 5px; text-align: center;"> <p>CO ♥</p> <p>FAIL ppm</p> <p>▣ A-CAL</p> </div> <p>2. Close the regulator.</p> <p>3. Unscrew the regulator.</p> <p>4. Remove the calibration cup.</p> <p>5. Press and release POWER MODE to return to the A-CAL screen in the A-CAL menu.</p> <p>6. See "Troubleshooting" on page 69.</p> |

Performing a Span Adjustment in E-CAL

The E-CAL item only appears if E-CAL in User Mode is set to **ON** (factory setting is **OFF**). If E-CAL is set to **OFF**, see page 46 for calibration instructions.

Preparing for Span Adjustment

To adjust the span on the CO-04, you need:

- Calibration gas cylinder
- 0.25 LPM fixed flow regulator

Table 10: Calibration Concentration Limits

| Channel | Min. Cal. Concentration | Max. Cal. Concentration |
|-----------------|-------------------------|-------------------------|
| Carbon Monoxide | 15 ppm | 2,000 ppm |

- Non-absorbent tubing
 - Calibration cup
1. Confirm that the CO-04's calibration gas value matches the concentration listed on the calibration gas cylinder as described on page 52.
 2. Confirm that the regulator knob is turned all the way clockwise. Screw the 0.25 LPM fixed flow regulator onto the calibration cylinder.
 3. Install the calibration cup onto the CO-04. Be sure the calibration cup is installed in the correct direction and that it is pushed on all the way.

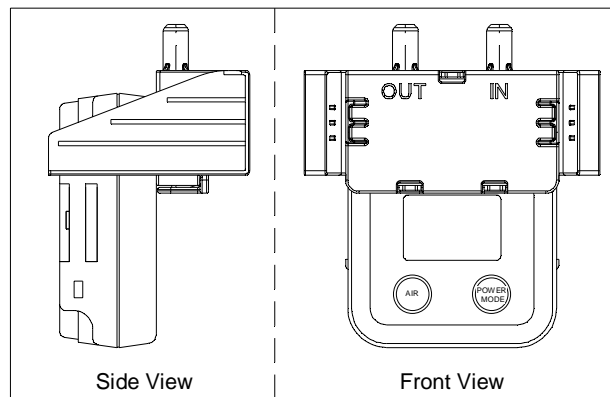

4. Use the tubing to connect the regulator to the inlet of the calibration cup (labeled "IN").

Performing a Calibration

1. While in User Mode, press AIR to scroll to **GAS CAL**.



2. Press and release POWER MODE. The **AIR** item appears.
3. Use AIR to scroll to the **E-CAL** item.

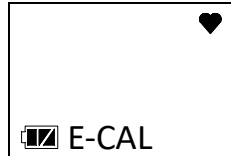

4. Press and release POWER MODE. The display shows the calibration value (see page 52 if the calibration value does not match the calibration gas cylinder's concentration).

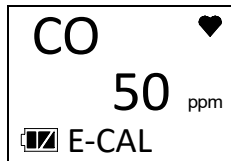

5. Press and release POWER MODE.
6. The gas reading flashes and the bottom of the screen says "GAS IN".

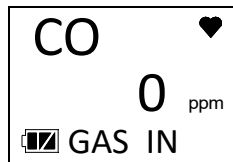

7. Turn the regulator knob counterclockwise to open the regulator.
8. Once the gas reading reaches 10% of the auto calibration value, the screen starts counting down from the time specified in the **E-CAL** User Mode item. In the example below, **E-CAL** is set to **60** seconds.

To back out of the gas application screen without performing the calibration, press and release AIR and POWER MODE together.

If the reading never reaches 10% of the auto calibration value, press and release POWER MODE to fail the calibration.

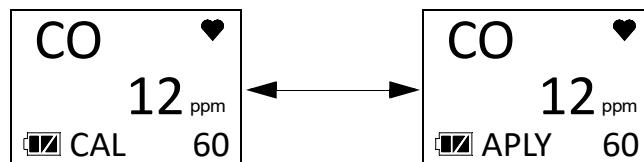

9. At the end of the countdown, the instrument makes the span adjustment.

10. The table below describes the 2 calibration outcomes.

| Calibration Passed | Calibration Failed |
|--|--|
| <p>1. The instrument indicates that the calibration passed.</p> <div data-bbox="464 338 659 470" style="border: 1px solid black; padding: 5px; margin: 10px 0;"> <p style="text-align: center;">PASS ♥</p> <p style="text-align: center;">E-CAL</p> </div> <p>2. The instrument shows the current gas reading.</p> <div data-bbox="464 569 659 701" style="border: 1px solid black; padding: 5px; margin: 10px 0;"> <p style="text-align: center;">CO ♥</p> <p style="text-align: center;">51 ppm</p> <p style="text-align: center;">E-CAL</p> </div> <p>3. If MAX.SPAN is set to ON (default is OFF, see page 95), the response reading's maximum adjustment is displayed. A maximum span of 100 ppm indicates that the reading could have been adjusted up to 100 ppm. If the maximum span value is close to the calibration gas value, the sensor should be replaced soon.</p> <p style="margin-left: 40px;">The maximum adjustment is either twice the calibration value or full scale, whichever is lower.</p> <div data-bbox="464 1220 659 1352" style="border: 1px solid black; padding: 5px; margin: 10px 0;"> <p style="text-align: center;">CO ♥</p> <p style="text-align: center;">91 ppm</p> <p style="text-align: center;">MAX .SPAN</p> </div> <p>4. Close the regulator.</p> <p>5. Remove the calibration cup.</p> <p>6. Press and release POWER MODE to enter Measuring Mode.</p> | <p>1. The instrument indicates that the calibration failed.</p> <div data-bbox="951 338 1146 470" style="border: 1px solid black; padding: 5px; margin: 10px 0;"> <p style="text-align: center;">CO ♥</p> <p style="text-align: center;">FAIL ppm</p> <p style="text-align: center;">E-CAL</p> </div> <p>2. Close the regulator.</p> <p>3. Unscrew the regulator.</p> <p>4. Remove the calibration cup.</p> <p>5. Press and release POWER MODE to return to the E-CAL screen in the E-CAL menu.</p> <p>6. See "Troubleshooting" on page 69.</p> |

Setting the Calibration Values in CAL--P

1. While in User Mode, press AIR to scroll to **GAS CAL**.



2. Press and release POWER MODE. The **AIR** item appears.
3. Use AIR to scroll to the **A-CAL** item (**E-CAL** if **E-CAL** in User Mode is set to **ON**).

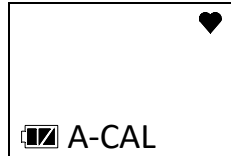

4. Press and release POWER MODE. The Auto Cal screen displays.

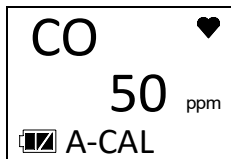

5. Use AIR to scroll to **CAL--P**.



6. Press and release POWER MODE. The gas name displays.



7. Press and release POWER MODE. The calibration value begins to flash.

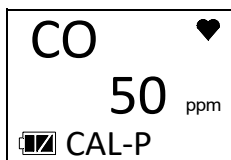

- Use AIR to adjust the calibration gas value. The calibration gas value in the instrument must match the value listed on the calibration gas cylinder you are using. Limits on the calibration gas value are shown in the table below.

| Channel | Min. Cal. Concentration | Max. Cal Concentration |
|-----------------|-------------------------|------------------------|
| Carbon Monoxide | 15 ppm | 2,000 ppm |

- Press and release POWER MODE to save the change. The calibration gas value stops flashing and the unit returns to the gas name screen.
- Use AIR to scroll to **ESCAPE**.
- Press and release POWER MODE to return to the **CAL--P** item in the **A-CAL** menu.
- Press AIR to scroll to **ESCAPE**.
- Press and release POWER MODE to return to the **A-CAL** item in the **GAS CAL** menu.
- See “Exiting the GAS CAL Menu” on page 53 to return to User Mode.

Exiting the GAS CAL Menu

- While in the **GAS CAL** menu, press AIR to scroll to **ESCAPE**.
- Press and release POWER MODE to return to the **GAS CAL** item in User Mode.
- See “Entering Measuring Mode (START)” on page 68 to enter Measuring Mode.

Setting Calibration Parameters (CAL SET)

The **CAL SET** menu has 4 items: **CAL.RMDR**, **CAL.INT**, **CAL.EXPD**, and **ESCAPE**.

- While in User Mode, press AIR to scroll to **CAL SET**.



- Press and release POWER MODE. The **CAL.RMDR** item appears.



CAL.RMDR

ON (factory setting): The CO-04 gives an indication at start up if it is due for calibration. The type of indication depends on the **CAL.EXPD** setting (see page 54).

OFF: The CO-04 does not give an indication at start up if it is due for calibration.

1. After entering the **CAL SET** menu, press AIR to scroll to **CAL.RMDR**.



2. Press and release POWER MODE. The current setting flashes.
3. Use AIR to display the desired setting.
4. Press and release POWER MODE to save the setting and return to the **CAL.RMDR** item in the **CAL SET** menu.
5. See “Exiting the CAL SET Menu” on page 55 to return to User Mode.

CAL.INT

This setting defines the amount of time between calibrations and can be set in 1 day increments. The minimum setting is 1 day and the maximum setting is 1000 days. The factory setting is 90 days.

1. After entering the **CAL SET** menu, press AIR to scroll to **CAL.INT**.



2. Press and release POWER MODE. The current setting flashes.
3. Use AIR to display the desired setting.
4. Press and release POWER MODE to save the setting and return to the **CAL.INT** item in the **CAL SET** menu.
5. See “Exiting the CAL SET Menu” on page 55 to return to User Mode.

CAL.EXPD

This item defines what indication is given during start up when calibration is due and **CAL.RMDR** is set to **ON** (factory setting).

CONFIRM (factory setting): The CO-04 gives an indication at start up if calibration is past due. Press and release AIR to continue without calibrating or press and release POWER MODE to enter User Mode and perform a calibration.

CANT.USE: The CO-04 gives an indication at start up that calibration is past due. Press and release POWER MODE to enter User Mode and perform a calibration. Pressing AIR has no effect. A successful calibration must be performed in order to use the instrument.

NONE: The CO-04 gives an indication at startup that calibration is past due. It is not necessary to acknowledge the indication. If desired, press POWER MODE to enter User Mode and perform a calibration. The warm-up sequence continues on its own.

1. After entering the **CAL SET** menu, press AIR to scroll to **CAL.EXPD**.



2. Press and release POWER MODE. The current setting flashes.
3. Use AIR to display the desired setting.
4. Press and release POWER MODE to save the setting and return to the **CAL.EXPD** item in the **CAL SET** menu.
5. See “Exiting the CAL SET Menu” on page 55 to return to User Mode.

Exiting the CAL SET Menu

1. While in the **CAL SET** menu, press AIR to scroll to **ESCAPE**.
2. Press and release POWER MODE to return to the **CAL SET** item in User Mode.
3. See “Entering Measuring Mode (START)” on page 68 to enter Measuring Mode.

Setting Bump Test Parameters (BUMP.SET)

The **BUMP.SET** menu has 5 items: **SETTING**, **BP.RMDR**, **BP.INT**, **BP.EXPD**, and **ESCAPE**.

1. While in User Mode, press AIR to scroll to **BUMP.SET**.



2. Press and release POWER MODE. The **SETTING** item appears.



SETTING

The **SETTING** menu has 5 items: **GAS.TIME**, **CHECK**, **CAL.TIME**, **A-CAL**, and **ESCAPE**.

1. After entering the **BUMP.SET** menu, press **AIR** to scroll to **SETTING**.



2. Press and release **POWER MODE**. The **GAS.TIME** item appears.

GAS.TIME

The **GAS.TIME** is the amount of time that the instrument is exposed to gas during a bump test. The available choices are **30** seconds (factory setting), **45** seconds, **60** seconds, and **90** seconds.

1. After entering the **SETTING** menu, press **AIR** to scroll to **GAS.TIME**.



2. Press and release **POWER MODE**. The current setting flashes.
3. Use **AIR** to display the desired setting.
4. Press and release **POWER MODE** to save the setting and return to the **GAS TIME** item in the **SETTING** menu.
5. See “Exiting the SETTING Menu” on page 57 to return to **BUMP.SET** menu.

CHECK

CHECK is the bump test tolerance value and is represented as a percentage of the calibration gas concentration. It is the percentage that the bump test reading can differ from the auto calibration value and still be considered a passed bump test. If the bump test reading differs more, the bump test fails. The available values are **10%**, **20%**, **30%**, **40%**, and **50%** (factory setting).

1. After entering the **SETTING** menu, press **AIR** to scroll to **CHECK**.

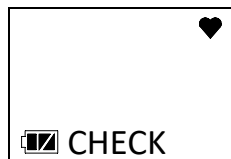

2. Press and release **POWER MODE**. The current setting flashes.
3. Use **AIR** to display the desired setting.
4. Press and release **POWER MODE** to save the setting and return to the **CHECK** item in the **SETTING** menu.
5. See “Exiting the SETTING Menu” on page 57 to return to **BUMP.SET** menu.

CAL.TIME

The **CAL.TIME** is the total time the instrument is exposed to calibration gas if **A-CAL** is set to **ON** and a bump test fails. The bump test time is deducted from the calibration time. For example, if the **CAL.TIME** is set to 90 seconds and the **GAS.TIME** is set to 30 seconds, if the bump test fails, the CO-04 is only exposed to gas for an additional 60 seconds. The available values are **90** seconds (factory setting), and **120** seconds.

1. After entering the **SETTING** menu, press AIR to scroll to **CAL.TIME**.



2. Press and release POWER MODE. The current setting flashes.
3. Use AIR to display the desired setting.
4. Press and release POWER MODE to save the setting and return to the **CAL.TIME** item in the **SETTING** menu.
5. See “Exiting the SETTING Menu” on page 57 to return to **BUMP.SET** menu.

A-CAL

ON (factory setting): If a bump test fails, the unit automatically begins a calibration.

OFF: If a bump test fails, the unit does not automatically begin a calibration.

1. After entering the **SETTING** menu, press AIR to scroll to **A-CAL**.

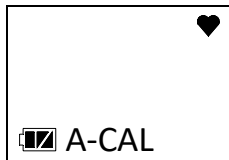

2. Press and release POWER MODE. The current setting flashes.
3. Use AIR to display the desired setting.
4. Press and release POWER MODE to save the setting and return to the **A-CAL** item in the **SETTING** menu.
5. See “Exiting the SETTING Menu” on page 57 to return to **BUMP.SET** menu.

Exiting the SETTING Menu

1. While in the **SETTING** menu, press AIR to scroll to **ESCAPE**.
2. Press and release POWER MODE to return to the **SETTING** item in the **BUMP.SET** menu.
3. See “Exiting the BUMP.SET Menu” on page 59 to return to User Mode.

BP.RMDR

ON: The CO-04 gives an indication at start up if it is due for bump testing. The type of indication depends on the **BP.EXPD** setting (see page 59). If the instrument is not due for bump testing, a check mark appears in the lower left corner of the LCD.

OFF (factory setting): The CO-04 does not give an indication at start up if it is due for bump testing.

1. After entering the **BUMP.SET** menu, press AIR to scroll to **BP.RMDR**.



2. Press and release POWER MODE. The current setting flashes.
3. Use AIR to display the desired setting.
4. Press and release POWER MODE to save the setting and return to the **BP.RMDR** item in the **BUMP.SET** menu.
5. See “Exiting the BUMP.SET Menu” on page 59 to return to User Mode.

BP.INT

This setting defines the amount of time between bump tests and can be set in 1 day increments. The minimum setting is **0** days and the maximum setting is **30** days (factory setting).

1. After entering the **BUMP.SET** menu, press AIR to scroll to **BP.INT**.



2. Press and release POWER MODE. The current setting flashes.
3. Use AIR to display the desired setting.
4. Press and release POWER MODE to save the setting and return to the **BP.INT** item in the **BUMP.SET** menu.
5. See “Exiting the BUMP.SET Menu” on page 59 to return to User Mode.

BP.EXPD

This item defines what indication is given during start up when a bump test is due and **BP.RMDR** is set to **ON** (factory setting is **OFF**).

CONFIRM (factory setting): The CO-04 gives an indication at start up if a bump test is past due. Press and release **AIR** to continue without bump testing or press and release **POWER MODE** to enter User Mode and perform a bump test.

CANT.USE: The CO-04 gives an indication at start up that a bump test is past due. Press and release **POWER MODE** to enter User Mode and perform a bump test. Pressing **AIR** has no effect. A successful bump test must be performed in order to use the instrument.

NONE: The CO-04 gives an indication at startup that a bump test is past due. It is not necessary to acknowledge the indication. If desired, press **POWER MODE** to enter User Mode and perform a bump test. The warm-up sequence continues on its own.

1. After entering the **BUMP.SET** menu, press **AIR** to scroll to **BP.EXPD**.



2. Press and release **POWER MODE**. The current setting flashes.
3. Use **AIR** to display the desired setting.
4. Press and release **POWER MODE** to save the setting and return to the **BP.EXPD** item in the **BUMP.SET** menu.
5. See “Exiting the BUMP.SET Menu” on page 59 to return to User Mode.

Exiting the BUMP.SET Menu

1. While in the **BUMP.SET** menu, press **AIR** to scroll to **ESCAPE**.
2. Press and release **POWER MODE** to return to the **BUMP.SET** item in User Mode.
3. See “Entering Measuring Mode (START)” on page 68 to enter Measuring Mode.

Alarm Settings (ALARM--P)

The **ALARM--P** menu has 3 items: **ALARM--P**, **DEF.ALMP**, and **ESCAPE**.

1. While in User Mode, press AIR to scroll to **ALARM--P**.



2. Press and release POWER MODE. The gas name displays.



Setting the Alarm Points

1. After entering the **ALARM-P** menu, press AIR to scroll to the gas name.

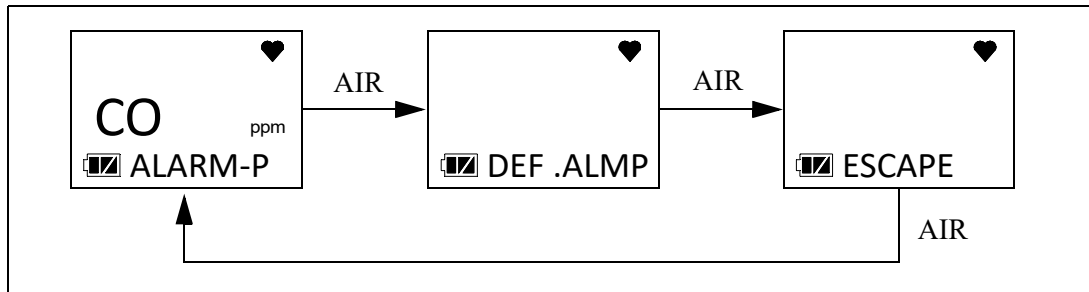

2. Press and release POWER MODE.
3. The Warning setpoint flashes.

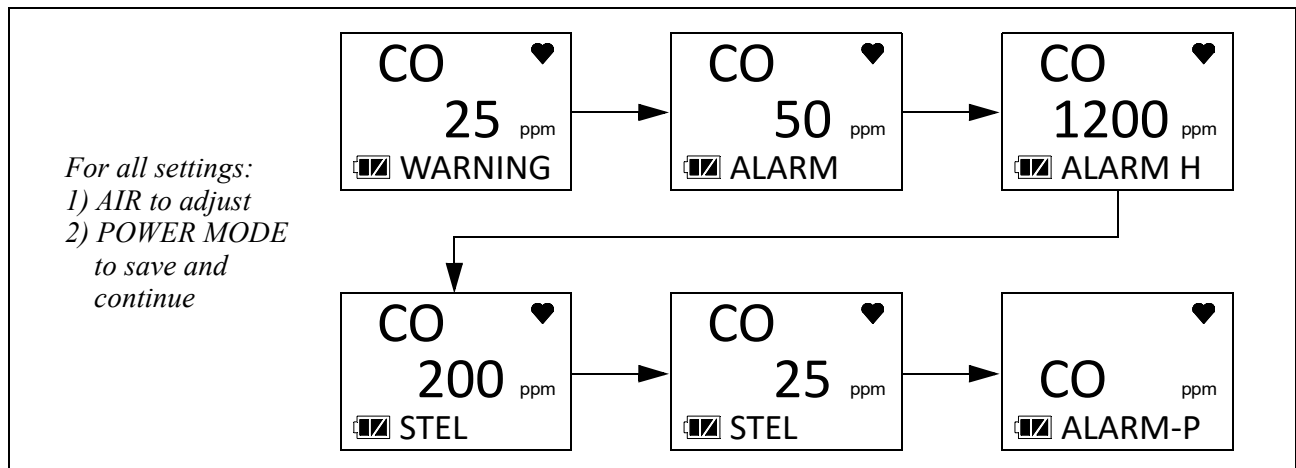

4. Use AIR to adjust the Warning setpoint. The alarm setpoint limitations are:
 $20 \text{ ppm} \leq \text{WARNING} \leq \text{ALARM} \leq \text{ALARM H} \leq 2000 \text{ ppm}$.

5. Press and release POWER MODE to save the setting.
6. Repeat Step 4 and Step 5 for the Alarm, Alarm H, STEL and TWA settings.
7. The instrument returns to the gas name screen.
8. See “ESCAPE” on page 61 to return to User Mode.

Defaulting the Alarm Points

Defaulting the alarm points defaults them back to factory settings as outlined in Table 1 on page 8 or to the settings saved in the **SAVE-AP** item in Gas Select Mode if you performed a **SAVE-AP** operation.

1. After entering the **ALARM-P** menu, press AIR to scroll to **DEF.ALMP**.



2. Press POWER MODE to enter the **DEF.ALMP** item.
3. Press POWER MODE to perform an alarm default. Press AIR to return to the **DEF.ALMP** item in the **ALARM-P** menu.
4. The instrument asks if you’re sure you want to default the alarm points.
5. Press POWER MODE to default the alarm points. Press AIR to return to the **DEF.ALMP** item in the **ALARM-P** menu.
6. See “ESCAPE” on page 61 to return to User Mode.

ESCAPE

1. While in the **ALARM-P** menu, press AIR to scroll to **ESCAPE**.
2. Press and release POWER MODE to return to the **ALARM--P** item in User Mode.
3. See “Entering Measuring Mode (START)” on page 68 to enter Measuring Mode.

Updating the Lunch Break Setting (LUNCH)

OFF (factory setting): The CO-04 automatically starts new TWA and PEAK reading collection and resets the time in operation at startup.

ON: The Lunch Break Screen displays during startup. From this screen, you can choose to continue accumulating TWA and PEAK readings and the time in operation from the last time the CO-04 was used or start collecting new readings and reset the time in operation.

1. While in User Mode, press AIR to scroll to **LUNCH**.



2. Press and release POWER MODE. The current setting flashes.
3. Use AIR to display the desired setting.
4. Press and release POWER MODE to save the setting and return to the **LUNCH** item in User Mode.
5. See “Entering Measuring Mode (START)” on page 68 to enter Measuring Mode.

Setting the Confirmation Beep and Non-Compliance Indicator (BEEP)

The **BEEP** menu has 3 items: **BEEP.SEL**, **BEEP.INT**, and **ESCAPE**.

1. While in User Mode, press AIR to scroll to **BEEP**.



2. Press and release POWER MODE. The **BEEP.SEL** item appears.



BEEP.SEL

BEEP.SEL defines what kind of confirmation or non-compliance indication you want to occur in Measuring Mode. The available choices are:

OFF (factory setting): The CO-04 does not provide a confirmation alert or non-compliance indicator.

LED: The CO-04's LED double flashes as often as defined by the **BEEP.INT** parameter to verify that the instrument is operating.

BUZZER: The CO-04's buzzer double beeps as often as defined by the **BEEP.INT** parameter to verify that the instrument is operating.

LED+BUZ: The CO-04's LED double flashes and the buzzer double beeps as often as defined by the **BEEP.INT** parameter to verify that the instrument is operating.

BMP/CAL: If a bump test or a calibration is due and if **BP.EXPD** or **CAL.EXPD** is set to **CONFIRM** (factory setting) or **NONE**, the CO-04's LED double flashes as often as defined by the **BEEP.INT** parameter to indicate a non-compliance. Once a bump test or calibration (depending on which is due) is done, the LED stop flashing.

1. While in the **BEEP** menu, press AIR to scroll to **BEEP.SEL**.



2. Press and release POWER MODE. The current setting flashes.
3. Use AIR to display the desired setting.
4. Press and release POWER MODE to save the setting and return to the **BEEP.SEL** item in the **BEEP** menu.
5. See "ESCAPE" on page 64 to return to User Mode.

BEEP.INT

The **BEEP.INT** parameter defines how often the confirmation alert or non-compliance indicator selected in **BEEP.SEL** occurs. This setting only applies if the **BEEP.SEL** parameter is set to something other than **OFF** (factory setting). The available choices are **0.5** minutes and **1-99** minutes in 1 minute increments. The factory setting is **5** minutes.

1. While in the **BEEP** menu, press AIR to scroll to **BEEP.INT**.



2. Press and release POWER MODE. The current setting flashes.
3. Use AIR to display the desired setting.

4. Press and release **POWER MODE** to save the setting and return to the **BEEP.INT** item in the **BEEP** menu.
5. See “**ESCAPE**” on page 64 to return to User Mode.

ESCAPE

1. While in the **BEEP** menu, press **AIR** to scroll to **ESCAPE**.
2. Press and release **POWER MODE** to return to the **BEEP** item in User Mode.
3. See “**Entering Measuring Mode (START)**” on page 68 to enter Measuring Mode.

Updating the Backlight Time (BL TIME)

This setting defines how long the LCD backlight stays on when you press any button. The minimum setting is **OFF**; the maximum setting is **255** seconds. The factory setting is **30** seconds.

1. While in User Mode, press **AIR** to scroll to **BL TIME**.



2. Press and release **POWER MODE**. The current setting flashes.
3. Use **AIR** to display the desired setting.
4. Press and release **POWER MODE** to save the setting and return to the **BL TIME** item in User Mode.
5. See “**Entering Measuring Mode (START)**” on page 68 to enter Measuring Mode.

Turning the Key Tone On/Off (KEY.TONE)

ON (factory setting): The instrument beeps when a button is pressed.

OFF: The instrument does not beep when a button is pressed.

1. While in User Mode, press **AIR** to scroll to **KEY.TONE**.



2. Press and release **POWER MODE**. The current setting flashes.
3. Use **AIR** to display the desired setting.
4. Press and release **POWER MODE** to save the setting and return to the **KEY.TONE** item in User Mode.

5. See “Entering Measuring Mode (START)” on page 68 to enter Measuring Mode.

Display Mode Items (DISP.SET)

OFF: **USER ID**, **STN ID**, and **BUZZ.VOL** screens do not appear in Display Mode.

ON (factory setting): **BUZZ.VOL** screen appears in Display Mode. **USER ID** and **STN ID** screens appear in Display Mode if **ID DISP** in Maintenance Mode is also set to **ON** (factory setting is **OFF**).

1. While in User Mode, press AIR to scroll to **DISP.SET**.



2. Press and release POWER MODE. The current setting flashes.
3. Use AIR to display the desired setting.
4. Press and release POWER MODE to save the setting and return to the **DISP.SET** item in User Mode.
5. See “Entering Measuring Mode (START)” on page 68 to enter Measuring Mode.

Zero Suppression (ZERO.SUP)

This item only appears if **ZSUP.DSP** is set to **ON** in Maintenance Mode (factory setting is **OFF**).

The **ZERO.SUP** setting is not intended for field adjustment. The default setting is **ON**. The suppression value is 2 ppm.

Zero Follower (ZERO.FLW)

This item only appears if **ZFLW.DSP** is set to **ON** in Maintenance Mode (factory setting is **OFF**).

The **ZERO.FLW** setting is not intended for field adjustment. The default setting is **ON**.

Turning Easy Calibration On/Off (E-CAL)

OFF (factory setting): Auto Calibration (A-CAL) item appears in GAS CAL menu instead of Easy Calibration (E-CAL).

XX seconds: Easy Calibration (E-CAL) item appears in GAS CAL menu instead of Auto Calibration (A-CAL). During a calibration, the instrument counts down from the number of seconds you select.

1. While in User Mode, press AIR to scroll to **E-CAL**.

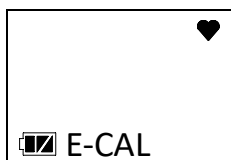

2. Press and release POWER MODE. The current setting flashes.
3. Use AIR to display the desired setting.
4. Press and release POWER MODE to save the setting and return to the **E-CAL** item in User Mode.
5. See “Entering Measuring Mode (START)” on page 68 to enter Measuring Mode.

Setting the Date/Time (DATE)

1. While in User Mode, place the cursor next to **DATE**.



2. Press and release POWER MODE. The date and time display with the year flashing.

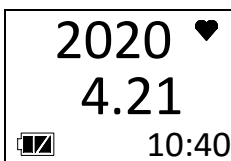

3. Use AIR to display the desired year.
4. Press and release POWER MODE to save the setting. The month setting flashes.
5. Repeat Step 3 and Step 4 to enter the month, day, hours, and minutes settings. The date and time are saved and the instrument returns to the **DATE** item in User Mode.
6. See “Entering Measuring Mode (START)” on page 68 to enter Measuring Mode.

Turning the Password On/Off (PASS-W)

ON: The CO-04 prompts you for a password when you enter User Mode. The factory-set password is **0405** but it can be changed.

OFF (factory setting): No password is required to enter User Mode.

1. While in User Mode, press AIR to scroll to **PASS-W**.

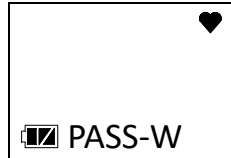

2. Press and release POWER MODE. The current setting flashes.
3. Use AIR to display the desired setting.
4. If you selected **OFF**, press and release POWER MODE to save the setting and return to the **PASS-W** item in User Mode.
If you selected **ON**, continue with Step 5.
5. Press and release POWER MODE. The Set Password Screen appears. The current password appears and the first digit flashes.

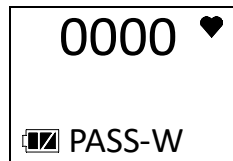

6. Use AIR to display a number from 0 to 9.
7. Press and release POWER MODE to enter the selection and advance to the next number. To go back a number, press and hold AIR and POWER MODE for a few seconds.
8. Repeat Step 6 and Step 7 to select the remaining numbers. When you press and release POWER MODE to enter the last number, the password is saved and the instrument returns to the **PASS-W** item in User Mode.
9. See "Entering Measuring Mode (START)" on page 68 to enter Measuring Mode.

Viewing the ROM/SUM (ROM/SUM)

The **ROM/SUM** screen shows the instrument's firmware version and firmware checksum.

1. While in User Mode, press AIR to scroll to **ROM/SUM**.

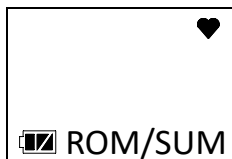

2. Press and release POWER MODE. The screen shows the ROM/SUM. The ROM is the top value and the SUM is the bottom value.

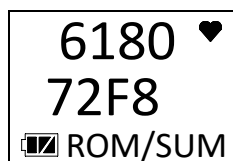

3. Press and release POWER MODE to return to the **ROM/SUM** item in User Mode.
4. See “Entering Measuring Mode (START)” on page 68 to enter Measuring Mode.

Entering Measuring Mode (START)

1. While in User Mode, press AIR to scroll to **START**.



2. Press and release POWER MODE. The instrument begins its warmup sequence.

Chapter 6: Maintenance

Overview

This chapter describes troubleshooting procedures for the CO-04. It also includes procedures for replacing the batteries and replacing various consumable parts.

WARNING: *RKI Instruments recommends that service, calibration, and repair of RKI gas detectors be performed by personnel properly trained for this work. Replacing the sensor and other parts with original equipment does not affect the intrinsic safety of the instrument.*

AVERTISSEMENT: *RKI Instruments recommande que le service, l'étalonnage et la réparation des détecteurs de gaz RKI soient effectués par du personnel dûment formé à ces travaux. Le remplacement du capteur et d'autres pièces par l'équipement d'origine n'affecte pas la sécurité intrinsèque de l'instrument.*

Troubleshooting

The troubleshooting table describes error messages, symptoms, probable causes, and recommended action for problems you may encounter with the CO-04.

Table 11: Troubleshooting the CO-04

| Symptoms | Probable Causes | Recommended Action |
|--|--|---|
| <ul style="list-style-type: none">The LCD is blank. | <ul style="list-style-type: none">The unit got turned off.The batteries needs to be replaced.The battery cover may not be completely closed. | <ol style="list-style-type: none">To turn on the unit, press and briefly hold POWER MODE.Replace the batteries.Be sure the battery cover is completely closed and that the screw is tight.If the difficulties continue, contact RKI Instruments, Inc. for further instruction. |
| <ul style="list-style-type: none">The LCD shows an abnormally high reading but other gas detection instruments do not. | <ul style="list-style-type: none">Charcoal filter needs to be replaced.The CO-04 needs to be recalibrated.The sensor needs replacement. | <ol style="list-style-type: none">Replace the charcoal filter.Recalibrate the unit.If the difficulties continue, replace the sensor and calibrate.If the difficulties continue, contact RKI Instruments, Inc. for further instruction. |

Table 11: Troubleshooting the CO-04

| Symptoms | Probable Causes | Recommended Action |
|--|---|--|
| <ul style="list-style-type: none"> • Calibration fails. | <ul style="list-style-type: none"> • The calibration value does not match the cylinder gas concentration. • The sample gas is not reaching the sensor because of a bad connection. • The calibration cylinder is out of gas or is outdated. • The sensor needs replacement. | <ol style="list-style-type: none"> 1. Make sure the CO-04 has been properly set up for calibration. 2. Check all calibration tubing for leaks or for any bad connections. 3. Verify that the calibration cylinder contains an adequate supply of fresh test sample. 4. If the fail condition continues, replace the sensor. 5. If the difficulties continue, contact RKI Instruments, Inc. for further instruction. |
| <ul style="list-style-type: none"> • Heart symbol at the top of the screen becomes steadily on or disappears. | <ul style="list-style-type: none"> • A microprocessor error has occurred. | <ul style="list-style-type: none"> • Contact RKI Instruments, Inc. for further instruction. |

Replacing the Batteries (Alkaline or Ni-MH)

WARNING: *To prevent ignition of a hazardous atmosphere, batteries must only be changed in an area known to be nonhazardous.*

AVERTISSEMENT: *Pour éviter l'inflammation d'une atmosphère dangereuse, la batterie ne doit être remplacée que dans une zone non dangereuse.*

WARNING: *Use only Duracell MN2400 or PC2400 or Eneloop BK-4MCC batteries to maintain the QPS classification of the CO-04. Use of other batteries will void the QPS classification and may void the warranty. Do not mix old/new or different types of batteries.*

AVERTISSEMENT: *Utiliser uniquement des piles Duracell MN 2400 ou PC 2400 ou Eneloop BK-4MCC de maintenir la classification QPS de la CO-04. L'utilisation d'autres piles annule la classification QPS et peut annuler la garantie. Ne mélangez pas les anciennes/nouvelles ou différents types de piles.*

Replace the batteries when the last bar in the battery icon is flashing.

1. Make sure the CO-04 is off.

2. Release the side of the alligator or belt clip that is opposite the hinge. You may need to use a screwdriver to pry it open.

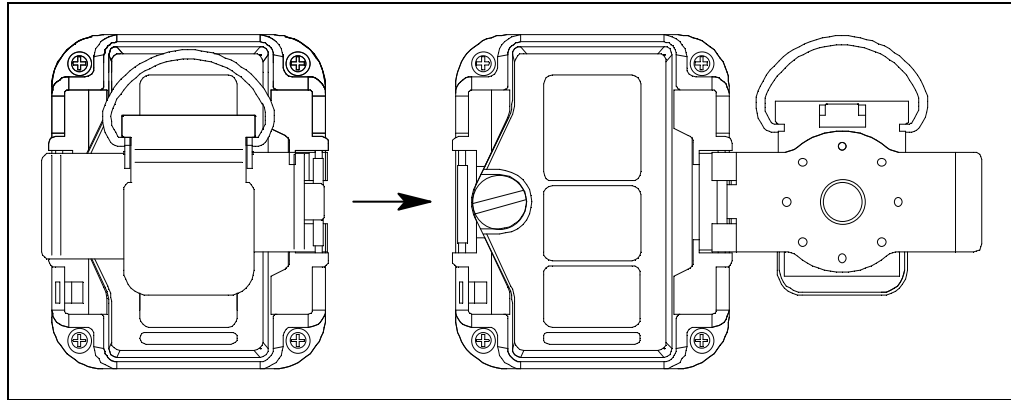

Figure 7: Releasing the Alligator or Belt Clip

3. Rotate the captive battery cover screw counterclockwise.

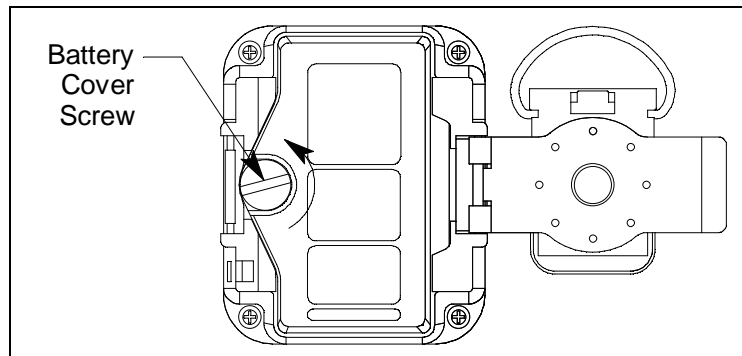

Figure 8: Unscrew Battery Cover Screw

4. Remove the battery cover.
5. Remove the old batteries.

NOTE: New batteries must be installed within 5 minutes to avoid having to reset the date/time.

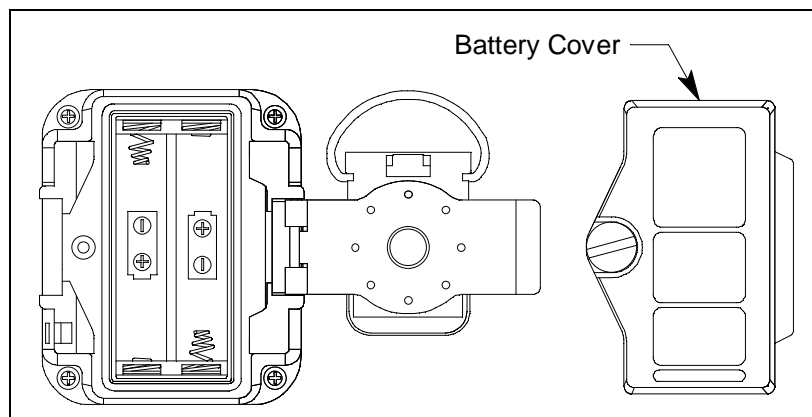

Figure 9: Battery Cover Removal

6. Install the new AAA batteries. Follow the diagram shown in the battery compartment.

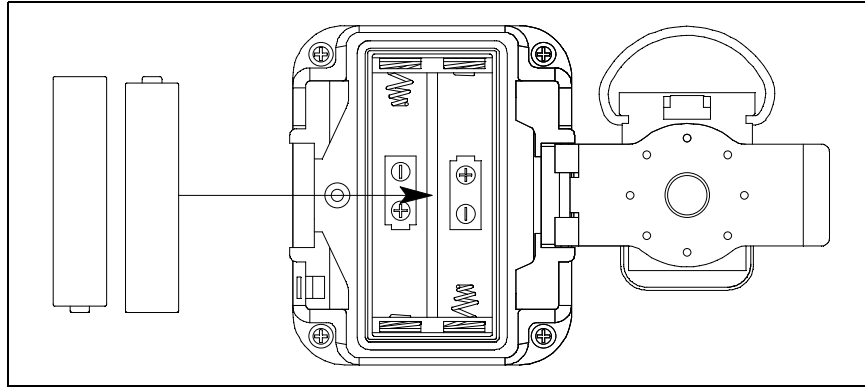

Figure 10: Installing New Batteries

7. Reinstall the battery cover and tighten the battery cover screw.
8. If the instrument has been without batteries for more than 5 minutes, the date and time are reset and need to be set again. When the new batteries are installed, the instrument automatically turns on and displays the Date/Time Screen. Set the date and time as described on page 66. Once the date and time are set, the instrument begins its warmup sequence. If you do not set the date and time within 30 seconds, the instrument automatically begins its warmup sequence.

Recharging the Batteries (Ni-MH Batteries Only)

Any battery charger capable of charging AAA Ni-MH batteries can be used to recharge the CO-04's Ni-MH batteries. RKI Instruments, Inc. recommends using one of the chargers specified on page 79.

WARNING: To prevent ignition of a hazardous atmosphere, batteries must only be charged in an area known to be nonhazardous.

1. Remove the batteries from the CO-04 as described in Step 1 - Step 5 on page 70.
2. Install the Ni-MH batteries in the charger. See the battery charger's manual for charging instructions.
3. Put the batteries back in the CO-04 and reinstall the battery cover.

Replacing the Charcoal Filter

1. Verify that the CO-04 is off.
2. Remove the rubber boot, if installed.
3. Use a small Phillips screwdriver to unscrew the 4 screws that attached the front case to the rear case.

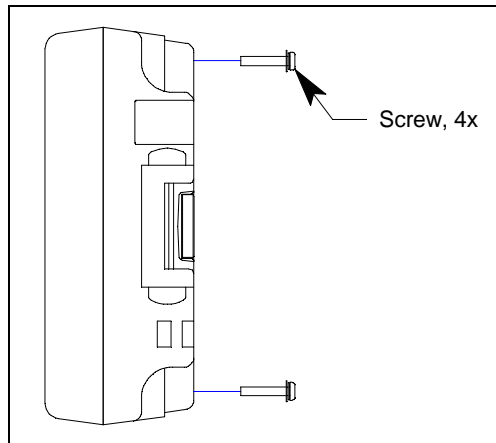

Figure 11: Unscrewing Case Screws

4. Turn the instrument right side up. The screws are not captive and may fall out. Be sure not to lose them.
5. Remove the front case from the rear case.

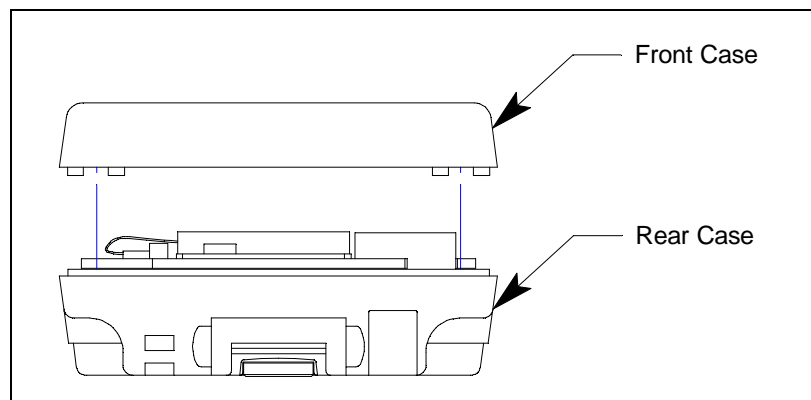

Figure 12: Case Separation

6. Turn the front case upside down.
7. If the sensor stayed in the front case, remove the sensor.

8. The charcoal filter sits in the middle of a black gasket. Pry the charcoal filter out of the gasket.

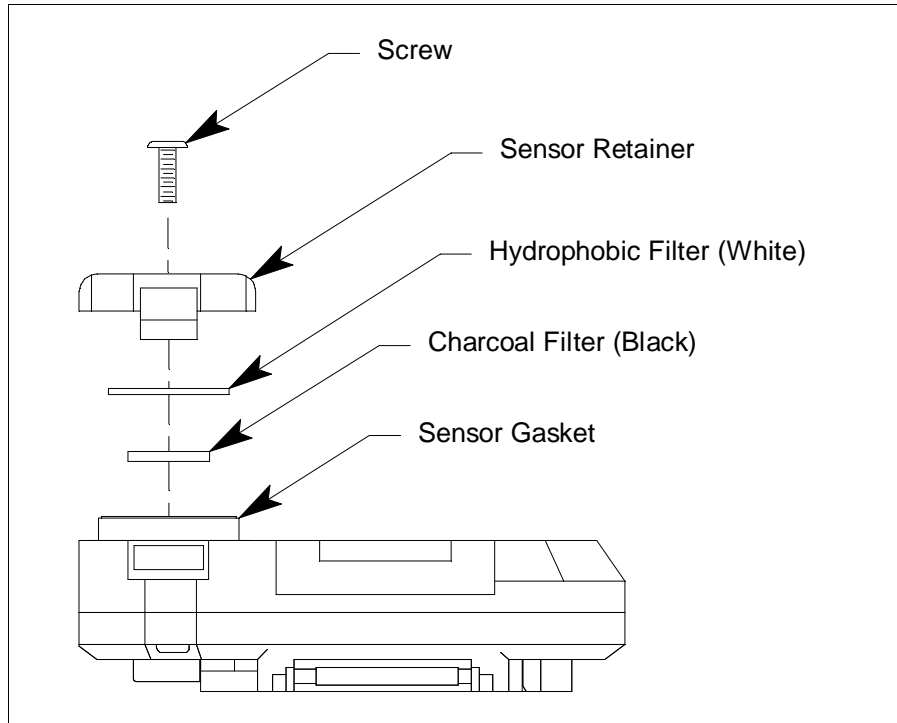

Figure 13: Charcoal Filter Location

9. Install a new charcoal filter. If the gasket got removed, install it with the flat side facing the white hydrophobic filter.
10. If necessary, put the sensor in the socket on the rear case. The colored side faces away from the rear case and the slots in the sensor line up with tabs in the socket.

CAUTION: Forcing a sensor into a socket without lining the sensor slots up with the socket tabs may damage the sensor or socket.

11. Reinstall the front case to the rear case.
12. Reinstall the 4 screws that were removed in Step 3.
13. Reinstall the rubber boot, if being used.

Replacing the Hydrophobic Filter

1. Verify that the CO-04 is off.
2. Remove the rubber boot, if installed.
3. Use a small Phillips screwdriver to unscrew the 4 screws that attached the front case to the rear case.

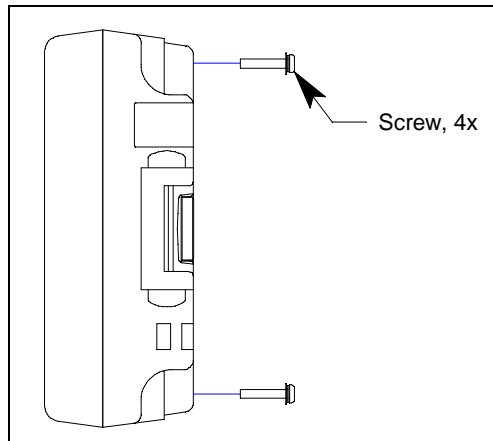

Figure 14: Unscrewing Case Screws

4. Turn the instrument right side up. The screws are not captive and may fall out. Be sure not to lose them.
5. Remove the front case from the rear case.

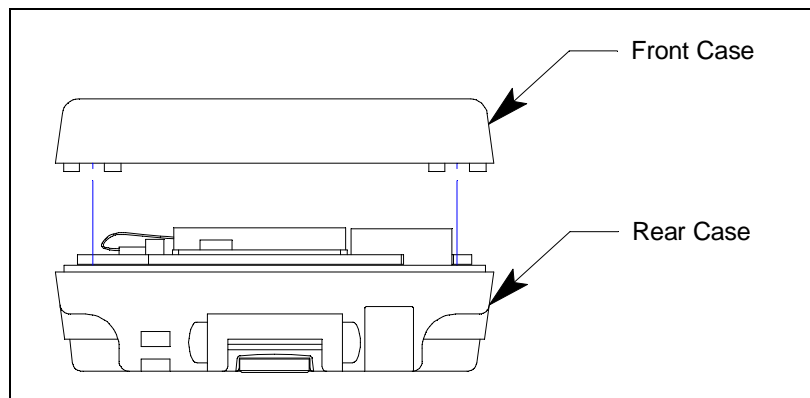

Figure 15: Case Separation

6. Turn the front case upside down.
7. If the sensor stayed in the front case, remove the sensor.
8. Carefully remove the sensor gasket and the black charcoal filter that sits in the middle of the sensor gasket.

9. Remove the white hydrophobic filter.

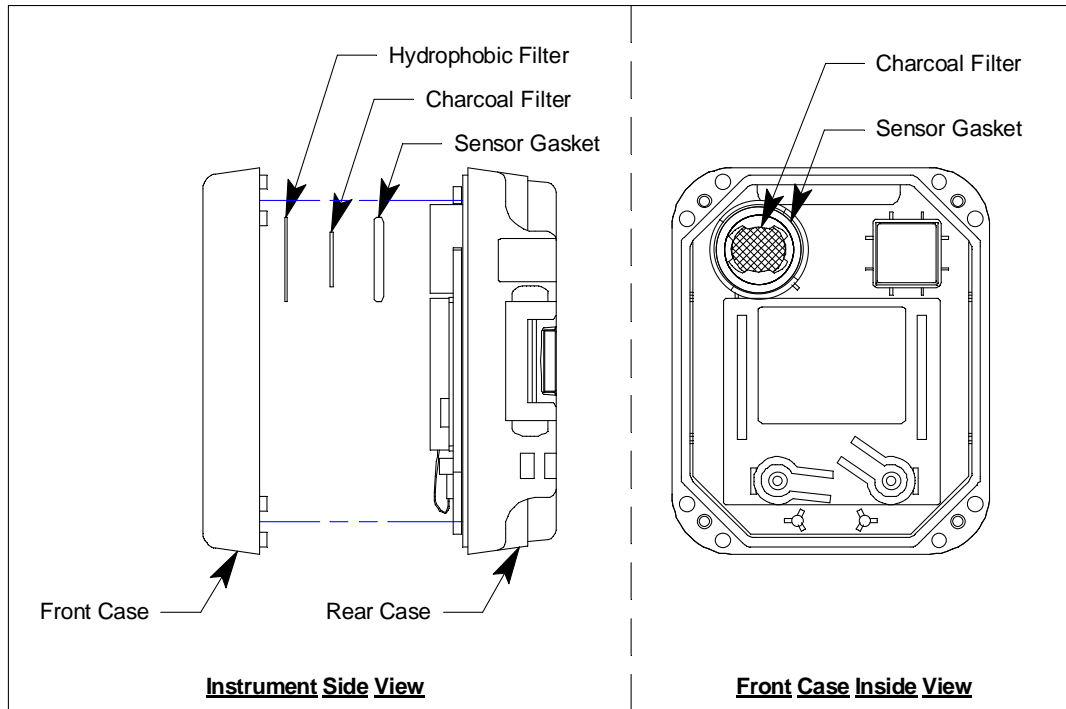

Figure 16: Hydrophobic Filter Location

10. Install a new hydrophobic filter.
11. Reinstall the sensor gasket with the flat side facing the white hydrophobic filter.
12. If the charcoal filter came loose, reinstall it in the middle of the sensor gasket.
13. If necessary, put the sensor in the socket on the rear case. The colored side faces away from the rear case and the slots in the sensor line up with tabs in the socket.

CAUTION: Forcing a sensor into a socket without lining the sensor slots up with the socket tabs may damage the sensor or socket.

14. Reinstall the front case to the rear case.
15. Reinstall the 4 screws that were removed in Step 3.
16. Reinstall the rubber boot, if being used.

Replacing the Sensor

1. Verify that the CO-04 is off.
2. Remove the rubber boot, if installed.
3. Use a small Phillips screwdriver to unscrew the 4 screws that attached the front case to the rear case.

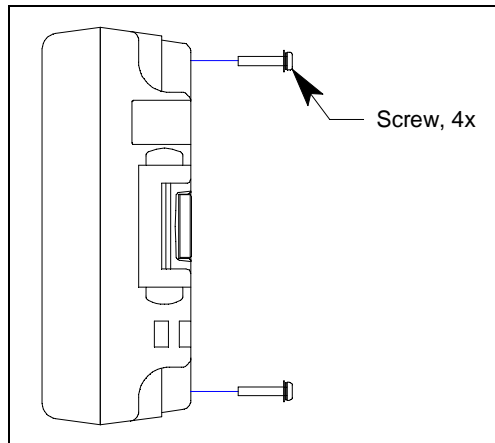

Figure 17: Unscrewing Case Screws

4. Turn the instrument right side up. The screws are not captive and may fall out. Be sure not to lose them.
5. Remove the front case from the rear case.

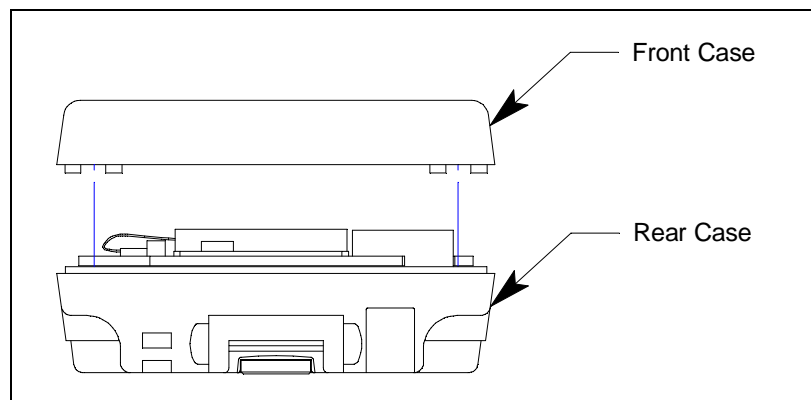

Figure 18: Case Separation

6. Turn the front case upside down.
7. Remove the old sensor. It will either be in its rear case socket or it will be stuck to the sensor gasket in the front case.

8. Install the new sensor in the socket on the rear case. The colored side faces away from the rear case and the slots in the sensor line up with tabs in the socket.

CAUTION: Forcing a sensor into a socket without lining the sensor slots up with the socket tabs may damage the sensor or socket.

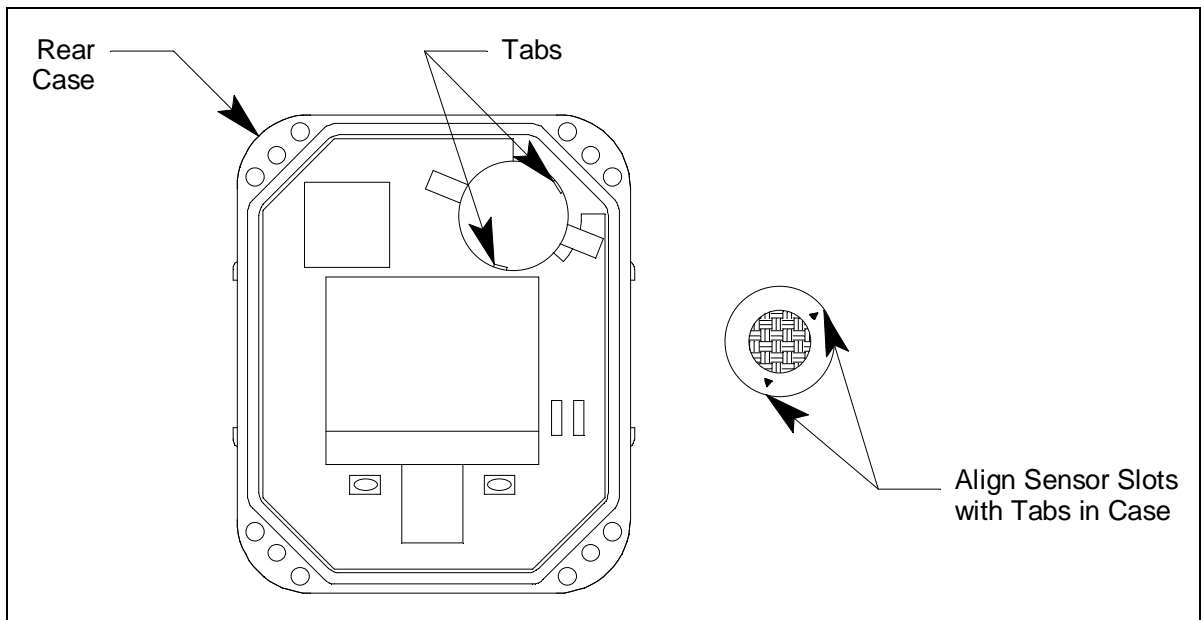

Figure 19: Sensor Location

9. Reinstall the front case to the rear case.
10. Reinstall the 4 screws that were removed in Step 3.
11. Reinstall the rubber boot, if being used.
12. Calibrate the CO response as described on page 43.

Chapter 7: General Parts List

Table 12: General Parts List

| Part Number | Description |
|--------------|--|
| 06-1248RK-03 | Calibration kit tubing, 3 foot length |
| 07-6033 | Sensor gasket |
| 10-1105-01 | Screw, for securing front case to rear case |
| 13-0112RK | Wrist strap |
| 13-0122 | Belt clip |
| 13-0128 | Alligator clip |
| 13-0204RK | Pins for connecting alligator clip/belt clip |
| 20-0325 | Rubber boot |
| 33-0175 | Hydrophobic filter |
| 33-7100 | Charcoal filter disk, 5 pack, for CO sensor |
| 47-5084RK | USB/IrDA adapter module, Legasic, for use with all premier portables (without USB cable) |
| 47-5084RK-01 | USB/IrDA adapter assembly, Legasic, for use with all premier portables (with module and USB cable) |
| 47-5085RK | Cable, USB A to USB mini, 6 feet, for 47-5084RK USB/IrDA adapter module |
| 49-1110RK | AAA size alkaline battery |
| 49-1312 | AAA size Ni-MH battery |
| 49-3105RK | 4-battery AA/AAA charger with AC adapter and DC vehicle adapter |
| 49-3106RK | 12-battery AA/AAA charger with AC adapter |
| 71-0525 | Operator's Manual, 04 Series Datalogging Program |
| 71-0526 | Operator's Manual, 04 Series Setup Program |
| 71-0600 | Operator's Manual, CO-04 (this document) |
| 81-0064RK-01 | Calibration cylinder, 50 ppm CO in air, 34 liter steel |
| 81-0064RK-03 | Calibration cylinder, 50 ppm CO in air, 103 liter |
| 81-0076RK-01 | Calibration cylinder, zero air, 34 liter steel |
| 81-0076RK-03 | Calibration cylinder, zero air, 103 liter |
| 81-1050RK-25 | Regulator, fixed flow, 0.25 LPM, with gauge and knob, for 17 liter and 34 liter steel cylinders (cylinders with external threads) |
| 81-1051RK-25 | Regulator, fixed flow, 0.25 LPM, with gauge and knob, for 34 liter aluminum, 58 liter, and 103 liter cylinders (cylinders with internal threads) |

Table 12: General Parts List (Continued)

| Part Number | Description |
|--------------------|--|
| 81-1146 | Calibration cup |
| 81-CO04C-LV | Calibration kit: 34 liter steel cylinder of 50 ppm CO in N ₂ , regulator, tubing, calibration cup, case |
| ESR-A13P-CO | Carbon monoxide (CO) sensor |

Appendix A: Maintenance Mode

Overview

This appendix describes the CO-04 in Maintenance Mode. The CO-04 is factory-set to suit most applications. Update settings in Maintenance Mode only if required for your specific application. Maintenance Mode items and their factory settings are listed in Table 13 below.

Table 13: Maintenance Mode Menu Items

| Maintenance Mode Menu Item | Description | | |
|----------------------------|--|--|---|
| GAS CAL (page 84) | Perform an air adjust, perform a span adjustment, change the calibration values. | | |
| | AIR | Perform a fresh air adjustment. | |
| | A-CAL or E-CAL depending on E-CAL User Mode setting | Perform a span adjustment and set the calibration gas concentration. | |
| | | A-CAL (or E-CAL) | Perform an automatic span adjustment. |
| | | START | Begin the warmup sequence and enter Measuring Mode. |
| | | CAL-P | Set the calibration gas concentration. |
| | | ESCAPE | Return to the A-CAL item in the GAS CAL menu. |
| ESCAPE | Return to the GAS CAL item in Maintenance Mode. | | |
| GAS.TEST (page 84) | Apply gas to test sensor response and observe alarm indications without an alarm event being recorded. | | |
| SEN.DATE (page 85) | View and/or set the replacement date for the sensor and the batteries. | | |
| BUMP (page 86) | Perform a bump test. | | |
| LATCH (page 86) | ON (factory setting): The CO-04 remains in alarm until the alarm condition passes <i>and</i> POWER MODE is pressed. OFF : The CO-04 automatically resets an alarm when the alarm condition passes. | | |
| D.ZERO (page 87) | ON (factory setting): You can manually perform a fresh air adjust in Measuring Mode by pressing AIR. OFF : You cannot manually perform a fresh air adjust in Measuring Mode by pressing AIR. | | |
| A.ZERO (page 87) | ON : The CO-04 asks if you want to perform a fresh air adjustment at the end of the startup sequence. OFF (factory setting): The CO-04 does not ask if you want to perform a fresh air adjustment at the end of the startup sequence. | | |

Table 13: Maintenance Mode Menu Items

| Maintenance Mode Menu Item | Description |
|-----------------------------------|---|
| ID DISP (page 88) | ON: User ID and Station ID screens appear in startup sequence. IDs can be changed in Display Mode if DISP.SET in User Mode is also set to ON . OFF (factory setting): User ID and Station ID screens do not appear in startup sequence. IDs cannot be changed in Display Mode. |
| ZERO.SUP (page 88) | ON (factory setting): Not intended for field adjustment. The suppression value is 2 ppm. |
| ZERO.FLW (page 88) | ON (factory setting): Not intended for field adjustment. |
| ZSUP.DSP (page 88) | ON: Zero suppression item appears in User Mode. OFF (factory setting): Zero suppression item does not appear in User Mode. (Zero suppression item is always available in Maintenance Mode) |
| ZFLW.DSP (page 89) | ON: Zero follower item appears in User Mode. OFF (factory setting): Zero follower item does not appear in User Mode. (Zero follower item is always available in Maintenance Mode) |
| CYL.DISP (page 89) | ON: CYL SEL item appears in GAS CAL . OFF (factory setting): CYL SEL item does not appear in GAS CAL . (RKI Instruments, Inc. does not recommend adjusting this setting.) |
| DATE (page 89) | Set the current date and time. |
| PASS-W (page 90) | ON (factory setting): Maintenance Mode is password-protected. Factory-set password is 0400 . OFF: Maintenance Mode is not password-protected. |
| ROM/SUM (page 91) | View the firmware information for the CO-04's sensor board and main board. |
| M.DEF (page 91) | Set all parameters back to their RKI factory settings. |
| START (page 92) | Press and release POWER MODE to begin the warmup sequence and enter Measuring Mode. |

Entering Maintenance Mode

WARNING: The CO-04 is not in operation as a gas detector while in Maintenance Mode.

1. Take the CO-04 to a non-hazardous location and turn it off if it is on.
2. Press and hold AIR, then press and hold POWER MODE. You will hear a beep after one second. Continue to hold the buttons down.
3. When you hear a second beep, release the buttons.

4. The screen that appears depends on the setting of Maintenance Mode's **PASS-W** item.
 If **PASS-W** is set to **OFF**, continue with Step 8.
 If **PASS-W** is set to **ON** (factory setting), continue with Step 5.

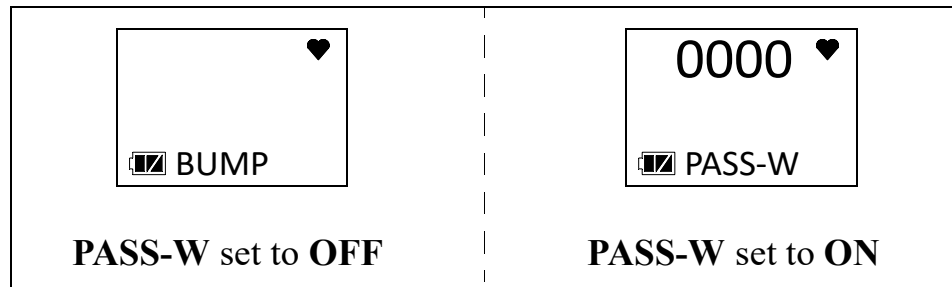

5. If **PASS-W** is set to **ON** in Maintenance Mode, a password screen appears and the first digit is flashing. The factory-set password is **0400** but it can be changed.
6. Use **AIR** to select each password number then press **POWER MODE** to save it and move on to the next number. To go back a number, press and hold **AIR** and **POWER MODE** for a few seconds. To reverse the direction of change (ie. from increasing to decreasing or vice versa):
 - a. Press and hold **AIR**.
 - b. Immediately press **POWER MODE** and then release both buttons.
7. Continue to Step 6.
8. The **GAS CAL** item displays.



9. Use **AIR** to move through the Maintenance Mode items.

Tips for Using Maintenance Mode

- To scroll from one item to the next, press and release **AIR**. To reverse the scrolling direction:
 - a. Press and hold **AIR**.
 - b. Immediately press **POWER MODE** and then release both buttons.
 - c. The scrolling direction returns to the original direction when you exit and reenter a menu.
- To skip an item when a question is asked, press and release **AIR**.
- To enter an item and to save any changes, press and release **POWER MODE**.

- To change a flashing parameter, press and release AIR. To reverse the direction of change (i.e. from increasing to decreasing or vice versa):
 - a. Press and hold AIR.
 - b. Immediately press POWER MODE and then release both buttons.
- To exit an entered item without saving a change, press and hold AIR and POWER MODE for a few seconds.

Performing a Calibration (GAS CAL)

See page 43 for a description of the **GAS CAL** item.

Performing a Gas Test (GAS.TEST)

The **GAS.TEST** item allows you to apply gas to the instrument and see all alarm indications except for the buzzer indication. There is no buzzer indication in the **GAS.TEST** menu even though the buzzer sounds in the event of a real gas alarm condition while in Measuring Mode. A gas test is not saved in logged data.

Preparing for a Gas Test

To perform a gas test on the CO-04, you need:

- A calibration gas cylinder. The concentrations should be above the alarm condition you want to check. Standard alarm points are listed on page 8.
 - A 0.25 LPM fixed flow regulator
 - Non-absorbent tubing
 - Calibration cup
1. Confirm that the regulator knob is turned all the way clockwise. Screw the 0.25 LPM fixed flow regulator onto the calibration cylinder.
 2. Install the calibration cup onto the CO-04. Be sure the calibration cup is installed in the correct direction and that it is pushed on all the way.

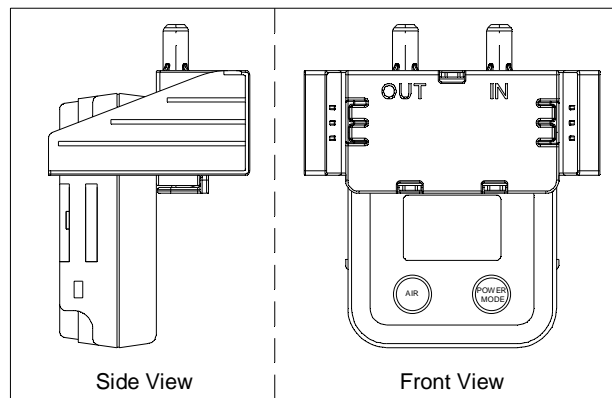

3. Use the tubing to connect the regulator to the inlet of the calibration cup (labeled “IN”).

Performing a Gas Test

1. While in Maintenance Mode, press AIR to scroll to **GAS.TEST**.



2. Press and release POWER MODE. The current gas reading displays. The bottom of the LCD alternates between "GAS.TEST" and "BUZZ.OFF".

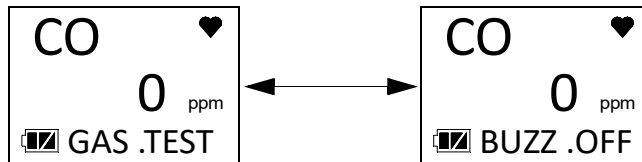

3. Turn the regulator knob counterclockwise to open the regulator.
4. The instrument initiates alarm indications except for the buzzer. There is no buzzer indication in the **GAS.TEST** menu even though the buzzer sounds in the event of a real gas alarm condition.
5. Turn the regulator knob clockwise to close the regulator.
6. Unscrew the regulator from the calibration cylinder.
7. Remove the calibration cup from the CO-04.
8. Store the calibration kit in a safe and convenient place.
9. Press and release POWER MODE to return to the **GAS.TEST** item in Maintenance Mode.
10. See "Entering Measuring Mode (START)" on page 92 to enter Measuring Mode.

Sensor/Battery Replacement Date (SEN.DATE)

The **SEN.DATE** item allows you to keep track of when the sensor and the batteries were replaced.

1. While in Maintenance Mode, press AIR to scroll to **SEN.DATE**.



2. Press and release POWER MODE. The sensor replacement date displays.

- Use AIR to scroll to the item whose replacement date you want to view or change.

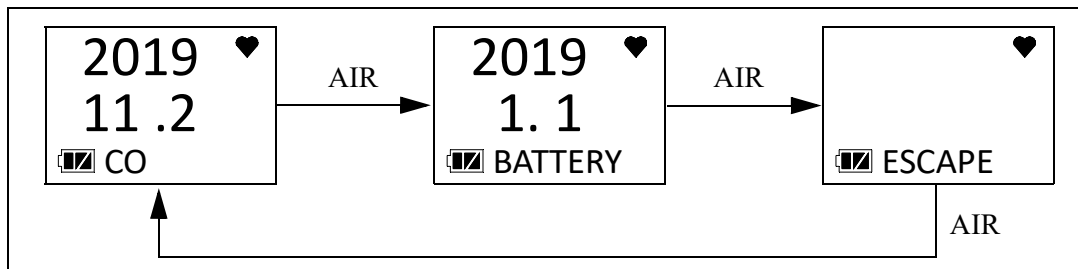

- To change the replacement date:
 - With the desired item displayed, press and release POWER MODE.
 - Press and release POWER MODE again to set the replacement date to the current date.
- Use the AIR button to scroll to **ESCAPE**.
- Press and release POWER MODE to return to the **SEN.DATE** item in Maintenance Mode.
- See “Entering Measuring Mode (START)” on page 92 to enter Measuring Mode.

Performing a Bump Test (BUMP)

See “Performing a Bump Test (BUMP)” on page 41 for a description of the **BUMP** item.

Setting Alarms to Latching or Self-Resetting (LATCH)

ON (factory setting): The CO-04 remains in alarm until the alarm condition passes *and* POWER MODE is pressed.

OFF: The CO-04 automatically resets an alarm when the alarm condition passes.

- While in Maintenance Mode, press AIR to scroll to **LATCH**.



- Press and release POWER MODE. The current setting flashes.
- Use AIR to display the desired setting.
- Press and release POWER MODE to save the setting and return to the **LATCH** item in Maintenance Mode.
- See “Entering Measuring Mode (START)” on page 92 to enter Measuring Mode.

Turning the Demand Zero Function On/Off (D.ZERO)

ON (factory setting): You can manually perform a fresh air adjust in Measuring Mode by pressing AIR.

OFF: You cannot manually perform a fresh air adjust in Measuring Mode.

1. While in Maintenance Mode, press AIR to scroll to **D.ZERO**.

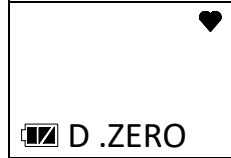

2. Press and release POWER MODE. The current setting flashes.
3. Use AIR to display the desired setting.
4. Press and release POWER MODE to save the setting and return to the **D.ZERO** item in Maintenance Mode.
5. See “Entering Measuring Mode (START)” on page 92 to enter Measuring Mode.

Turning the Auto Zero Function On/Off (A.ZERO)

ON: The CO-04 asks if you want to perform a fresh air adjustment at the end of the startup sequence.

OFF (factory setting): The CO-04 does not ask if you want to perform a fresh air adjustment at the end of the startup sequence.

1. While in Maintenance Mode, press AIR to scroll to **A.ZERO**.

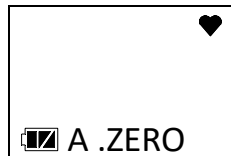

2. Press and release POWER MODE. The current setting flashes.
3. Use AIR to display the desired setting.
4. Press and release POWER MODE to save the setting and return to the **A.ZERO** item in Maintenance Mode.
5. See “Entering Measuring Mode (START)” on page 92 to enter Measuring Mode.

Turning the ID Display Function On/Off (ID DISP)

ON: The User ID and Station ID screens appear in the startup sequence. If **DISP.SET** in User Mode is also set to **ON**, then the IDs can be changed in Display Mode.

OFF (factory setting): The User ID and Station ID screens do not appear in the startup sequence and the IDs cannot be changed in Display Mode.

1. While in Maintenance Mode, press AIR to scroll to **ID DISP**.



2. Press and release POWER MODE. The current setting flashes.
3. Use AIR to display the desired setting.
4. Press and release POWER MODE to save the setting and return to the **ID DISP** item in Maintenance Mode.
5. See “Entering Measuring Mode (START)” on page 92 to enter Measuring Mode.

Turning the Zero Suppression On/Off (ZERO.SUP)

The **ZERO.SUP** setting is not intended for field adjustment. The default setting is **ON**. The suppression value is 2 ppm.

Turning the Zero Follower On/Off (ZERO.FLW)

The **ZERO.FLW** setting is not intended for field adjustment. The default setting is **ON**.

User Mode Zero Suppression (ZSUP.DSP)

ON: Zero suppression item appears in User Mode.

OFF (factory setting): Zero suppression item does not appear in User Mode. The zero suppression item is always available in Maintenance Mode.

It is not normally necessary to have the zero suppression item appear in User Mode. Contact RKI Instruments before turning this setting on.

User Mode Zero Follower (ZFLW.DSP)

ON: Zero follower item appears in User Mode.

OFF (factory setting): Zero follower item does not appear in User Mode. The zero follower item is always available in Maintenance Mode.

It is not normally necessary to have the zero follower item appear in User Mode. Contact RKI Instruments before turning this setting on.

Cylinder Setting (CYL.DISP)

ON: CYL SEL item appears in User and Maintenance Modes' GAS CAL item.

OFF (factory setting): CYL SEL item does not appear in User and Maintenance Modes' GAS CAL item.

Setting the Date/Time (DATE)

1. From the main menu, place the cursor next to **DATE**.



2. Press and release POWER MODE. The date and time display with the year flashing.

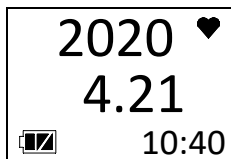

3. Use AIR to display the desired year.
4. Press and release POWER MODE to save the setting. The month setting flashes.
5. Repeat Step 3 and Step 4 to enter the month, day, hours, and minutes settings. The date and time are saved and the instrument returns to the **DATE** item in Maintenance Mode.
6. See “Entering Measuring Mode (START)” on page 92 to enter Measuring Mode.

Turning the Password On/Off (PASS-W)

ON (factory setting): The CO-04 prompts you for a password when you enter Maintenance Mode. The factory-set password is **0400** but it can be changed.

OFF: No password is required to enter Maintenance Mode.

1. While in Maintenance Mode, press AIR to scroll to **PASS-W**.

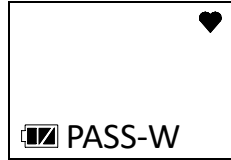

2. Press and release POWER MODE. The current setting flashes.
3. Use AIR to display the desired setting.
4. If you selected **OFF**, press and release POWER MODE to save the setting and return to the **PASS-W** item in User Mode.
If you selected **ON**, continue with Step 5.
5. Press and release POWER MODE. The Set Password Screen appears. The current password displays and the first digit flashes.

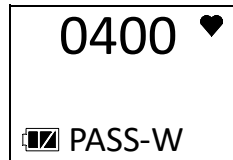

6. Use AIR to display a number from 0 to 9.
7. Press and release POWER MODE to enter the selection and advance to the next number. To go back a number, press and hold AIR and POWER MODE for a few seconds.
8. Repeat Step 6 and Step 7 to select the remaining numbers. When you press and release POWER MODE to enter the last number, the password is saved and the instrument returns to the **PASSWORD** item in Maintenance Mode.
9. See “Entering Measuring Mode (START)” on page 92 to enter Measuring Mode.

Viewing the ROM/SUM (ROM/SUM)

The **ROM/SUM** screen shows the instrument's firmware version and firmware checksum.

1. While in Maintenance Mode, press AIR to scroll to **ROM/SUM**.

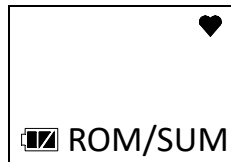

2. Press and release POWER MODE. The screen shows the ROM/SUM. The ROM is the top value and the SUM is the bottom value.

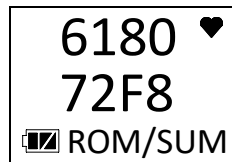

3. Press and release POWER MODE to return to the **ROM/SUM** item in Maintenance Mode.
4. See “Entering Measuring Mode (START)” on page 92 to enter Measuring Mode.

Performing a Default (M.DEF)

Performing a default operation in Maintenance Mode returns all parameters to their RKI factory settings.

1. While in Maintenance Mode, press AIR to scroll to **M.DEF**.



2. Press and release POWER MODE.

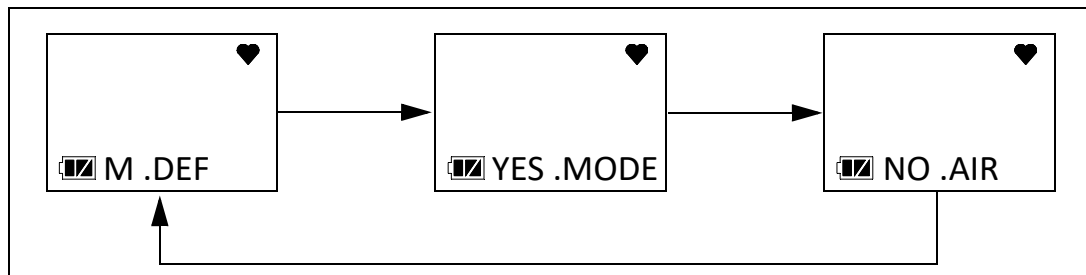

3. Press and release POWER MODE to perform a default operation. The instrument asks if you are sure you want to perform a default operation.

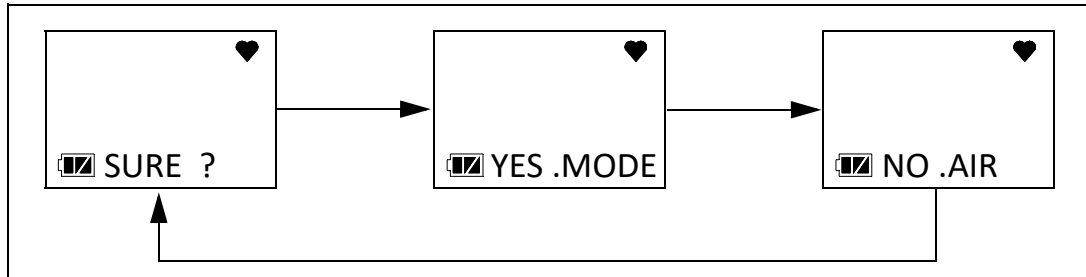

4. Press and release POWER MODE to perform a default operation. The instrument beeps twice and returns to the **M.DEF** item in Maintenance Mode.
5. See “Entering Measuring Mode (START)” on page 92 to enter Measuring Mode.

Entering Measuring Mode (START)

1. While in Maintenance Mode, press AIR to scroll to **START**.



2. Press and release POWER MODE. The instrument begins its warmup sequence.

Appendix B: Gas Select Mode

Overview

This appendix describes the CO-04 in Gas Select Mode. The CO-04 is factory-set to suit most applications. Update settings in Gas Select Mode only if required for your specific application. A description of the Gas Select Mode items is shown in Table 14 below.

Table 14: Gas Select Mode Menu Items

| Menu Item (Page # of Description) | Description |
|-----------------------------------|--|
| SAVE-AP (page 94) | Set the current alarm points as the default alarm points. |
| MAX.SPAN (page 95) | ON : Maximum span screen appears after a successful calibration. OFF (factory setting) : No maximum span screen appears. |
| STEALTH (page 96) | STEALTH ON : No backlight, LED, or buzzer operation. STEALTH OFF (factory setting) : Backlight, LED, and buzzer operate normally. |
| | This setting has no effect unless STEALTH is set to ON. VIB ON : Vibrator activates for alarm conditions. VIB OFF (factory setting) : Vibrator does not activate in any situation. |
| START (page 96) | Enter Measuring Mode |

Entering Gas Select Mode

WARNING: The CO-04 is not in operation as a gas detector while in Gas Select Mode.

1. Take the CO-04 to a non-hazardous location and turn it off if it is on.
2. Press and hold AIR, then press and hold POWER MODE. You will hear a beep after one second. Continue to hold the buttons down.
3. You will hear a second beep. Continue to hold the buttons down.
4. When you hear a third beep, release the buttons.
5. A password screen appears and the first digit flashes. The password is **2014**.

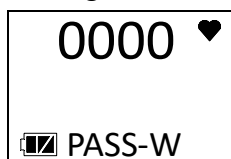

- Use AIR to select each password number then press POWER MODE to save it and move on to the next number. To go back a number, press and hold AIR and POWER MODE for a few seconds.
- The **SAVE-AP** item displays.



- Use AIR to move through the Gas Select Mode items.

Tips for Using Gas Select Mode

- To scroll from one item to the next, press and release AIR. To reverse the scrolling direction:
 - Press and hold AIR.
 - Immediately press POWER MODE and then release both buttons.
 - The scrolling direction returns to the original direction when you exit and reenter a menu.
- To skip an item when a question is asked, press and release AIR.
- To enter an item and to save any changes, press and release POWER MODE.
- To change a flashing parameter, press and release AIR. To reverse the direction of change (ie. from increasing to decreasing or vice versa):
 - Press and hold AIR.
 - Immediately press POWER MODE and then release both buttons.
- To exit an entered item without saving a change, press and hold AIR and POWER MODE for a few seconds.

Saving the Alarm Points (SAVE-AP)

Performing a **SAVE-AP** operation saves the current alarm setpoints.

Performing a **DEF.ALMP** operation in the **ALARM-P** User Mode menu sets the instrument's alarm points to those saved during the **SAVE-AP** operation (if performed).

Performing a **SAVE-AP** has no effect on an **M.DEF** in Maintenance Mode. An **M.DEF** operation returns all instrument settings to the RKI default regardless of if a **SAVE-AP** operation was performed.

- While in Gas Select Mode, press AIR to scroll to **SAVE-AP**.



2. Press and release POWER MODE. The display cycles through the following screens.

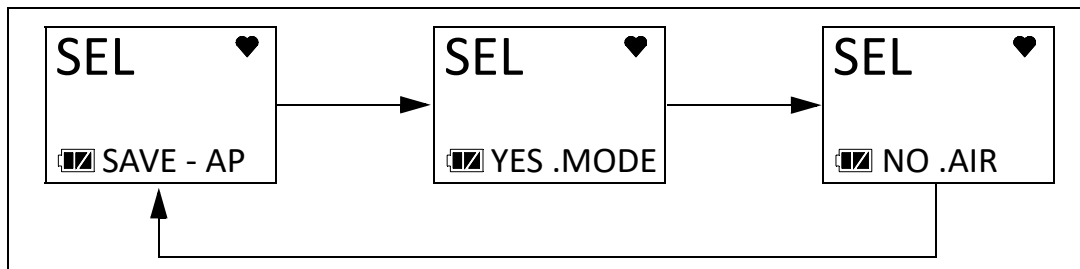

3. Press and release POWER MODE to save the current alarm point settings as the default.
4. The instrument returns to the **SAVE-AP** item in Gas Select Mode.
5. See “Exiting Gas Select Mode (START)” on page 96 to enter Measuring Mode.

Turning Calibration Max Span On/Off (MAX.SPAN)

ON: After a passed calibration, the CO-04 displays the response reading’s maximum adjustment. A maximum span of 100 ppm indicates that the reading could have been adjusted up to 100 ppm. If the maximum span value is close to the calibration value, the sensor should be replaced soon. The upper limit on the maximum adjustment indicated is either twice the calibration value or full scale, whichever is lower.

OFF (factory setting): There is no maximum span indication at the end of a calibration.

1. While in Gas Select Mode, press AIR to scroll to **MAX.SPAN**.



2. Press and release POWER MODE. The current setting flashes.
3. Use AIR to display the desired setting.
4. Press and release POWER MODE to save the setting and return to the **MAX.SPAN** item in Gas Select Mode.
5. See “Exiting Gas Select Mode (START)” on page 96 to enter Measuring Mode.

Stealth and Vibrator Settings (STEALTH)

STEALTH

ON:

- The instrument's backlight does not come on, regardless of the **BL TIME** setting.
- The instrument's LED does not come on for any reason, even alarm conditions.
- The instrument's buzzer does not sound for any reason, even alarm conditions.
- An "S" appears at the bottom of the LCD.

OFF (factory setting): The instrument's backlight, LED, and buzzer operate normally.

VIB

The **VIB** setting only affects instrument operation if **STEALTH** is set to **ON**.

ON: The vibrator activates for alarm conditions. It can be useful to have this feature turned on if you have also turned **STEALTH** on.

OFF (factory setting): The vibrator does not activate for any reason.

1. While in Gas Select Mode, press AIR to scroll to **STEALTH**.



2. Press and release POWER MODE. The current **STEALTH** setting flashes.
3. Use AIR to display the desired setting.
4. Press and release POWER MODE. The current **VIB** setting flashes.
5. Use AIR to display the desired setting.
6. Press and release POWER MODE to save the setting and return to the **STEALTH** item in Gas Select Mode.
7. See "Exiting Gas Select Mode (START)" on page 96 to enter Measuring Mode.

Exiting Gas Select Mode (START)

1. While in Gas Select Mode, press AIR to scroll to **START**.



2. Press and release POWER MODE. The instrument begins its warm-up sequence.

Warranty

RKI Instruments, Inc. warrants the CO-04 sold by us to be free from defects in materials, workmanship, and performance for a period of three years from the date of shipment from RKI Instruments, Inc. This includes the instrument and the original sensor. Replacement parts are warranted for 1 year from the date of their shipment from RKI Instruments, Inc. except for replacement sensors which are warranted for 3 years. Any parts found defective within their warranty period will be repaired or replaced, at our option, free of charge. This warranty does not apply to those items which by their nature are subject to deterioration or consumption in normal service, and which must be cleaned, repaired, or replaced on a routine basis. Examples of such items are:

- Absorbent cartridges
- Filter elements, disks, or sheets
- Pump diaphragms and valves

Warranty is voided by abuse including mechanical damage, alteration, rough handling, or repair procedures not in accordance with the instruction manual. This warranty indicates the full extent of our liability, and we are not responsible for removal or replacement costs, local repair costs, transportation costs, or contingent expenses incurred without our prior approval.

THIS WARRANTY IS EXPRESSLY IN LIEU OF ANY AND ALL OTHER WARRANTIES AND REPRESENTATIONS, EXPRESSED OR IMPLIED, AND ALL OTHER OBLIGATIONS OR LIABILITIES ON THE PART OF RKI INSTRUMENTS, INC. INCLUDING BUT NOT LIMITED TO THE WARRANTY OF MERCHANTABILITY OR FITNESS FOR A PARTICULAR PURPOSE. IN NO EVENT SHALL RKI INSTRUMENTS, INC. BE LIABLE FOR INDIRECT, INCIDENTAL, OR CONSEQUENTIAL LOSS OR DAMAGE OF ANY KIND CONNECTED WITH THE USE OF ITS PRODUCTS OR FAILURE OF ITS PRODUCTS TO FUNCTION OR OPERATE PROPERLY.

This warranty covers instruments and parts sold to users only by authorized distributors, dealers, and representatives as appointed by RKI Instruments, Inc.

We do not assume indemnification for any accident or damage caused by the operation of this gas monitor and our warranty is limited to replacement of parts or our complete goods.

CALL GEOTECH TODAY

(800) 833-7958

Geotech Environmental Equipment, Inc.

2650 East 40th Avenue • Denver, Colorado 80205

(303) 320-4764 • FAX (303) 322-7242

email: sales@geotechenv.com • website: www.geotechenv.com