

# USER MANUAL



## Honeywell BW™ Flex Series

Portable Multiple Gas Detector

**Honeywell**

M05-4002-003 EN-Rev. A



# Table Of Contents

---

Safety .....	4
<b>Introduction .....</b>	<b>5</b>
Product Description .....	5
Standards and Certifications .....	5
What's in the Box .....	7
Overview .....	7
Display Elements .....	8
<b>Operations .....</b>	<b>9</b>
Out of the Box First Run .....	9
Set Language, Time, and Date .....	9
Activate the Detector .....	11
Self Test .....	11
Deactivate the Detector .....	12
Common Button Operations .....	12
Bluetooth Pairing .....	13
Calibration .....	14
Bump Test .....	23
Force Calibration and Bump .....	30
Zero Calibration .....	30
Capture Real Time Reading .....	30
Configure the detector Settings via DC .....	31
<b>Maintenance .....</b>	<b>33</b>
Clean the Detector .....	33
Charge the Battery .....	33
Update Firmware .....	36
Replace the Belt Clip or Klick Fast Stud .....	37
Replace the Sensor Filter .....	38
Replace a Sensor .....	39

---

<b>Additional Information</b> .....	<b>41</b>
Sensor Poisons and Contaminants .....	41
Sensor Specifications .....	42
General Specifications .....	43
Troubleshooting .....	44
DataLogs and Event Logs .....	46
Alarms .....	47
Combustible Sensor Information .....	49
Filtered and Unfiltered Catalytic Bead Combustible (LEL) Sensor Information .....	50
User Preferences .....	53
Replacement Parts .....	56
Accessories .....	57
Security Information .....	58
Contact Us .....	60

# Safety



## WARNINGS

- The BW Flex Series detector with LEL-IR sensor (PN with W5) will not detect some combustible gases like **Hydrogen** or **Acetylene**. For detectable combustible gases, See "Combustible Sensor Information" on page 49 for more information. If your application has one or more of these hazards, please consult Honeywell Analytics to determine the best solution.
- High off-scale LEL readings may indicate an explosive concentration.



## CAUTION

- The detector is a personal safety Device. It is your responsibility to respond properly to the alarm.
- For safety reasons, this equipment must be operated and serviced by qualified personnel only.
- The Li-ion battery in this product presents a risk of fire, explosion, and chemical burn if misused. Do not disassemble, incinerate, or heat above 212°F (100°C). Batteries exposed to heat at 266°F (130°C) for 10 minutes can cause fire and explosion. Batteries must only be charged in a safe area free of hazardous gas.
- Deactivating the detector by removing the battery pack may cause improper operation and harm the detector.
- Use only Honeywell approved battery chargers such as the vehicle Charger.
- Do not use the Detector if it is damaged. Inspect the Detector before use. Look for cracks and missing parts.
- Honeywell recommends bumping test the sensors before each day's use to confirm their ability to respond to gas by exposing the detector to a gas concentration that exceeds the alarm setpoints. Manually verify that the audible and visual alarm activate. Calibrate if the readings are not within the specified limits.
- Protect the catalytic combustible sensor from exposure to lead compounds, silicone, and chlorinated hydrocarbons. Although certain organic vapors (Such as leaded gasoline and halogenated hydrocarbons) may temporarily inhibit sensor performance, in most cases, the sensor will recover after calibration.
- Honeywell recommends the catalytic combustible sensor be checked with a known concentration of calibration gas after any known exposure to catalytic contaminants or poisons (sulfur compounds, silicon vapors, halogenated compounds, etc.).
- The catalytic combustible sensor is factory calibrated to 50% LEL methane. If monitoring a different combustible gas in the % LEL range, calibrate the sensor using the appropriate gas.

# 1 Introduction

Learn what you need to know about the Honeywell BW™ Flex Series Gas Detector before operating.

## Product Description

The Honeywell BW™ Flex Series gas detector warns of hazardous gas at levels above user-defined alarm setpoints. The detector can monitor up to four gases at a time.

## Standards and Certifications

### IECEX: IECEX SIR 20.0020X

With IR sensor installed: Ex ia op is I Ma, Ex ia op is IIC T4 Ga,  $-40^{\circ}\text{C} \leq T_{\text{amb}} \leq 60^{\circ}\text{C}$

With LEL sensor installed: Ex da ia I Ma, Ex da ia IIC T4 Ga,  $-40^{\circ}\text{C} \leq T_{\text{amb}} \leq 60^{\circ}\text{C}$

With IR and LEL sensor installed: Ex da ia op is I Ma, Ex da ia op is IIC T4 Ga,  $-40^{\circ}\text{C} \leq T_{\text{amb}} \leq 60^{\circ}\text{C}$

Without IR and LEL sensor installed: Ex ia I Ma, Ex ia IIC T4 Ga,  $-40^{\circ}\text{C} \leq T_{\text{amb}} \leq 60^{\circ}\text{C}$

### ATEX: Sira 20ATEX2012X

With IR sensor installed:



I M1 Ex ia op is I Ma,  $-40^{\circ}\text{C} \leq T_{\text{amb}} \leq 60^{\circ}\text{C}$



II 1G Ex ia op is IIC T4 Ga,  $-40^{\circ}\text{C} \leq T_{\text{amb}} \leq 60^{\circ}\text{C}$

With LEL sensor installed:



I M1 Ex da ia I Ma,  $-40^{\circ}\text{C} \leq T_{\text{amb}} \leq 60^{\circ}\text{C}$



II 1G Ex da ia IIC T4 Ga,  $-40^{\circ}\text{C} \leq T_{\text{amb}} \leq 60^{\circ}\text{C}$

With IR and LEL sensor installed:

 I M1 Ex da ia op is I Ma,  $-40^{\circ}\text{C} \leq T_{\text{amb}} \leq 60^{\circ}\text{C}$

 II 1G Ex da ia op is IIC T4 Ga,  $-40^{\circ}\text{C} \leq T_{\text{amb}} \leq 60^{\circ}\text{C}$

Without IR and LEL sensor installed:

 I M1 Ex ia I Ma,  $-40^{\circ}\text{C} \leq T_{\text{amb}} \leq 60^{\circ}\text{C}$

 II 1G Ex ia IIC T4 Ga,  $-40^{\circ}\text{C} \leq T_{\text{amb}} \leq 60^{\circ}\text{C}$

Contains FCC ID: SU3RMBLED

Contains IC: 20969-RMBLED

CAN ICES-3(A)/NMB-3(A)

#### FCC Compliance statement

This Detector complies with part 15 of the FCC Rules. operation is subject to the following two conditions: (1) This Detector may not cause harmful interference, and (2) this Detector must accept any interference received, including interference that may cause undesired operation.

Note: This equipment has been tested and found to comply with the limits for a Class A digital Detector, pursuant to part 15 of the FCC Rules. These limits are designed to provide reasonable protection against harmful interference when the equipment is operated in a commercial environment. This equipment generates, uses, and can radiate radio frequency energy and, if not installed and used in accordance with the instruction manual, may cause harmful interference to radio communications. Operation of this equipment in a residential area is likely to cause harmful interference in which case the user will be required to correct the interference at his own expense.

# What's in the Box

1	Honeywell BW™ Flex Series gas detector
1	Battery (factory-installed)
1	USB charger
1	Calibration cap
1	Klick Fast stud
1	Quick Reference Guide
1	Tubing



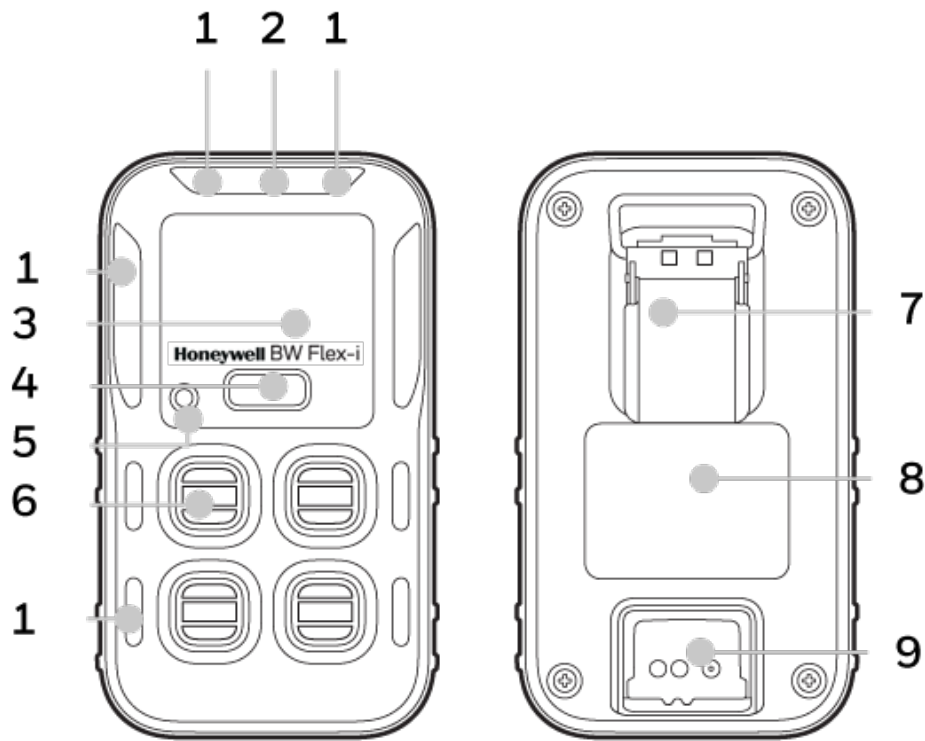







# Overview

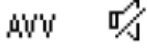

1	Alarm LED	6	Sensor
2	IntelliFlash	7	Clip
3	Display	8	Certification, model and Serial Number
4	Button	9	Charging and IR connection Port
5	Beeper		



# Display Elements

	<ul style="list-style-type: none"> <li>• Battery full</li> <li>• Battery half</li> <li>• Static icon</li> <li>• Battery low, Battery charging</li> <li>• Flashing icon: battery critical; Battery can't be charged</li> </ul>
	<ul style="list-style-type: none"> <li>• BLE connected</li> <li>• BLE fault</li> <li>• IR connected</li> <li>• Profile mode</li> </ul>
	<ul style="list-style-type: none"> <li>• AVV failed</li> <li>• Stealth mode</li> </ul>
	<ul style="list-style-type: none"> <li>• Sensor fault</li> <li>• Sensor EOL</li> </ul>
	<ul style="list-style-type: none"> <li>• Cal fail / due</li> <li>• Cal countdown</li> <li>• Predictive Cal due</li> </ul>
	<ul style="list-style-type: none"> <li>• Bump fail / due</li> <li>• Bump countdown</li> </ul>
	<ul style="list-style-type: none"> <li>• Inert Mode</li> </ul>
	<ul style="list-style-type: none"> <li>• Press and hold the button</li> </ul>
	<ul style="list-style-type: none"> <li>• Wait</li> <li>• Warning</li> <li>• Pass</li> <li>• Fail</li> </ul>
	<ul style="list-style-type: none"> <li>• Back</li> <li>• Next</li> </ul>
	<ul style="list-style-type: none"> <li>• Information</li> <li>• Bump</li> <li>• Zero</li> <li>• Calibration</li> <li>• Exit</li> </ul>

# 2 Operations

Learn what you can do with your Honeywell BW™ Flex Series Detector, from commissioning to Calibration.

## Out of the Box First Run

This operation is only executed the first time the detector is turned on.

1. Turn on the Detector. LEDs flash red, Sensors warm up, and the Detector performs the following Self-Tests: Battery, Firmware, BLE, Sensors, and Bump and Calibration due date.
2. After completing the Self-Test, you are asked to set the detector up in four ways: Manually, BLE, IR Link, and IntelliDoX.
3. Single-press the button to select a setup method.
4. Press and hold the button to initiate the selected method. For a detailed description of each method, go to See "Set Language, Time, and Date" below for more information.
5. After the initial setup is complete, the IntelliFlash flashes green every fifteen seconds, and the detector goes to the Regular mode. You are now ready to select any operation from the main menu.

Note: We strongly recommend to review the Alarm Settings after Start-Up.

## Set Language, Time, and Date

Configure the Language, time, and Date in a new detector on the first run setup.

There are four ways to set the Time Zone and Language in a new detector:

- Manual configuration via onscreen instructions.
- Via Device Configurator (DC) on a mobile device.
- Via Safety Suite Device Configurator (SSDC) on a computer.
- Via an IntelliDoX Docking Module. For further reference see the *IntelliDoX User Manual*.

## Configure the Detector Manually

1. Turn on the Detector and wait until you see the "Setup Manually" screen.
2. On the "Setup Manually" screen, press and hold the button. The Language selection menu is displayed.

You can select from the following languages:

English, Deutsch, Español, French, Italian, Portuguese, Russian, Nederlands, Simplified Chinese, Traditional Chinese, and Korean.

3. Single press to switch **Languages**, and Press and hold to select it. After you select the language, the Time setup is displayed.
4. Single press to switch **Hours, Minutes, and Seconds**; press and hold to select. After you set the time, the Date menu is displayed.
5. Single press to switch **Month, Day, and Year**.
6. Press, and Hold to save data. The detector goes to the Regular mode.

## Configure the detector via DC on a Mobile Device

1. Turn on the detector and the mobile device.
2. Pair your detector with the mobile device. For a detail pairing process, go to See "Bluetooth Pairing" on page 13 for more information..
3. After pairing, the Quick Setup window requests to Continue or Cancel. Tap **OK** to continue.
4. Choose **Language and Time Zone**, and then tap **Save** to complete the setup.

## Configure the detector via SSDC on a computer

Configure the detector via the Safety Suite Device Configurator (SSDC) software. You can download SSDC from: [https://explore.honeywell.com/safety\\_suite\\_device\\_configurator.html](https://explore.honeywell.com/safety_suite_device_configurator.html)

1. Connect the detector to a computer via IR Link.
2. Open the SSDC software.
3. Click on the Device List View tab.
4. Click Refresh to scan for devices.

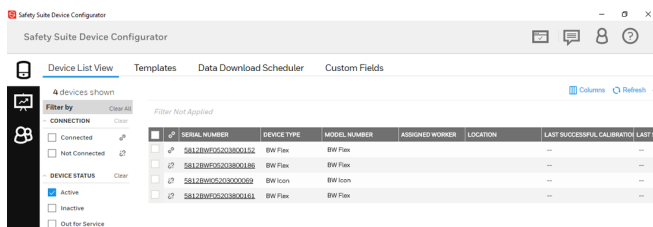

5. Select the detector's serial number. The Out of Box popup window is displayed.
6. Choose language and time zone, then click **SET** to complete the process.

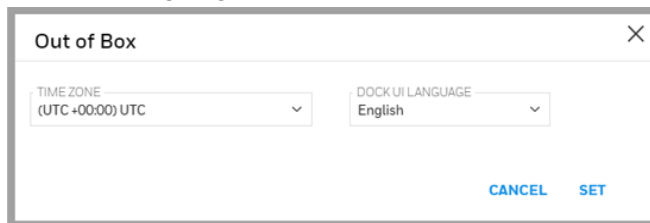

# Activate the Detector

To turn the detector on, press, and hold the button for four seconds. LEDs light and the instrument vibrates and beeps.

The detector performs a Self Test, the IntelliFlash flashes amber, and Sensors warm-up.

During the Sensor warm-up, the sensors LEDs flash clockwise.

In the regular mode, the IntelliFlash flashes green every fifteen seconds.

## Self Test

When the detector is activated, it performs several start-up tests:

**Firmware**  
BL V1.01  
APP V1.060.0

Firmware Version

**BLE**  
V1.01

BLE Version

**EOL**  
CO  
30 DAYS

End Of Life sensors, if any.

**Bump Due**  
SO2  
1 DAY

Bump Due Date by sensor

**Cal Due**  
SO2  
60 DAYS

Calibration Due Date by sensor

**Low**  
O2  
19.5 %VOL

Low Alarm Setpoint by sensor

**High**  
H2S  
14.0 PPM

High Alarm Setpoint by sensor

**STEL**  
H2S  
15.0 PPM

STEL Alarm Setpoint by sensor

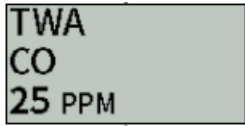

TWA Alarm Setpoint by sensor

When the detector has passed all the start-up self-tests, it enters the regular operation mode.

Sensor's Auto Zero is disabled by default but can be customized by the user.

Note: We strongly recommend to review the Alarm Settings after Start-Up.

## Deactivate the Detector

To deactivate your Honeywell BW™ Flex Series detector, press the button, and hold for four seconds.

The detector beeps and vibrates, and the alarm LEDs light red.

## Common Button Operations

Feature	Operation
Power On	4-second hold
Power Off	4-second hold
Enter the menu	Double-Press
Exit the menu (on Exit screen)	Press and hold
Move to Next Option menu	Single-Press
Initiate Selected Option	3-second hold
Acknowledge latched alarm	1-second hold
Backlight	Single-Press

# Bluetooth Pairing

You can pair the Honeywell BW™ Flex Series detector to a mobile device via built-in Bluetooth Low Energy (BLE) and The Honeywell Device Configurator app. If you do not have the app installed on your mobile device, you can download it from your Google Play Store or App Store.

The Honeywell Device Configurator app can show gas readings and alarms from the BW Flex Series unit that is connected, and then, send this data to the Honeywell remote monitoring software.

On the Honeywell BW™ Flex Series, the Bluetooth connection is on by default.

1. Turn On the BW Flex Series detector and your mobile device.
2. In your mobile device, activate the Bluetooth and open the Device Configurator app.
3. Select the detector's serial number in the Available Devices list.

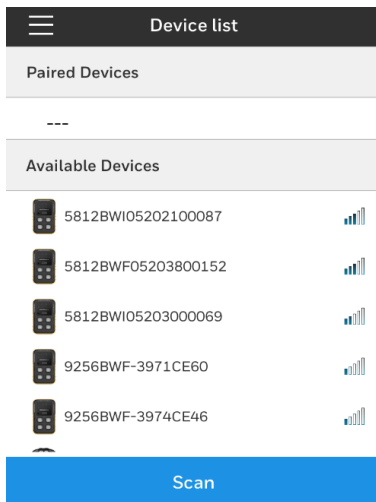

4. Input the pairing code displayed on the detector's screen to complete the BLE pairing.

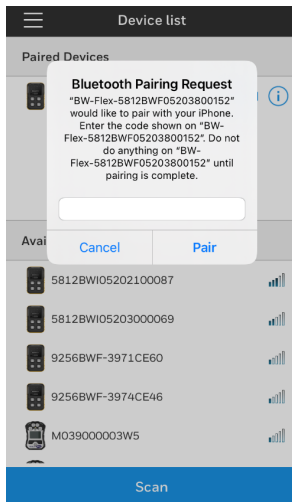

# Calibration

Perform a calibration to adjust the sensitivity levels of sensors and ensure accurate responses to gases.

The detector can be calibrated in four ways:

- Manual calibration via the instrument's menu.
- Via the Safety Suite Device Configurator (SSDC) software.
- Via the Device Configurator (DC) app.
- Use an IntelliDoX docking module. For further reference see the *IntelliDox User Manual*.



## CAUTION

- Move to a normal atmosphere (20.9% v/v O<sub>2</sub>) that is free of hazardous gas.
- Calibrate the Detector before first-time use and then on a regular schedule, depending on use and sensor exposure to poisons and contaminants. Honeywell recommends that the sensors be calibrated regularly and at least once every 180 days (6 months).

### Details for calibration and maintenance:

- PN with W5 is Non-dispersive IR, with W6 is filtered Catalytic bead technology, with W7 is unfiltered catalytic bead technology.
- The catalytic combustible sensor is factory calibrated to 50% LEL methane. If monitoring a different combustible gas in the % LEL range, calibrate the sensor using the appropriate gas.
- The IR combustible sensor will be calibrated to 50%LEL methane and must only be calibrated with methane. See "Combustible Sensor Information" on page 49 for more information. for approximate response to other target gases.

## Guidelines

When calibrating the detector, adhere to the following guidelines.

- Recommended gas mixture:
  - CO: 100 ppm balance N<sub>2</sub>
  - H<sub>2</sub>S: 25 ppm balance N<sub>2</sub>
  - LEL: 50% LEL or 2.5% for NA (2.2% for EU) by vol. methane balance air
  - O<sub>2</sub>: 18% by volume, balance N<sub>2</sub>. SO<sub>2</sub>: 20ppm balance N<sub>2</sub>.
- To ensure accurate calibration, use a premium-grade calibration gas. Gases approved by the National Institute of Standards and Technology (NIST) improve the accuracy of the calibration.
- Do not use a gas cylinder past its expiration date.
- Calibrate a new sensor before use. Install the sensor, activate the detector, and allow the sensor to stabilize before starting calibration (used sensor: 60 seconds / new sensor: 5 minutes, for X1 and X2 O<sub>2</sub> stabilization takes 24 hours. For W5 IR Sensor, 5 minutes stabilization is needed.
- Calibrate the sensors at least once every 180 days, depending on use and sensor exposure to poisons and contaminants.

- Calibrate the detector if the gas readings varies during start up.
- Calibrate the sensor before defining the alarm setpoints.
- Calibrate only in a safe area that is free of hazardous gas in an atmosphere of 20.9% oxygen.
- Do not calibrate the detector during or immediately after charging is complete.
- The oxygen sensor can be automatically calibrated each time upon activation (if this feature is enabled). Activate the detector in a normal (20.9%/20.8% oxygen) atmosphere.
- Allow the detector to stabilize for 1 minute after activation before performing a calibration or bump test.
- If a certified calibration is required, contact Honeywell.



## Calibrate the Detector via the menu

1. Turn On the BW Flex Series detector, and wait to sensors warm up.
2. Double-press the button to enter the menu.
3. Single press the button to locate **Calibration** and hold the button to select it. The detector starts Zero Calibration automatically.
4. After Zero Calibration is complete, place the cap over the detector, and press it down on both tabs to snap it into place.

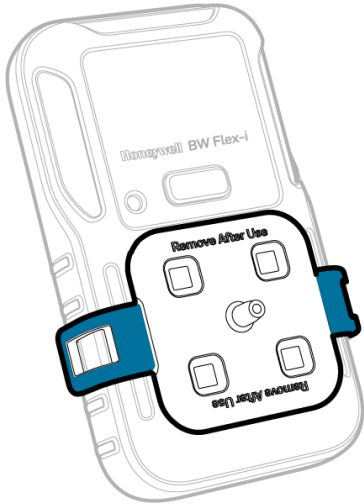

5. Attach the hose.

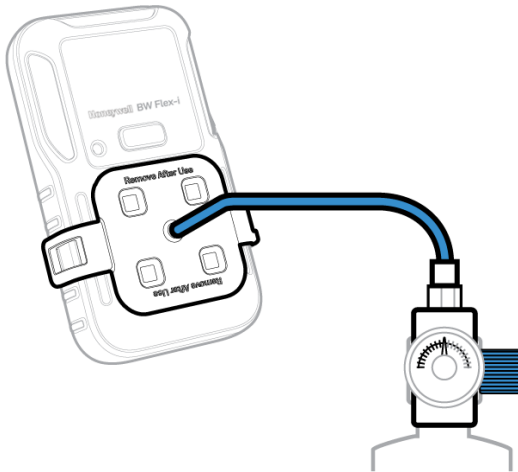

6. Follow on-screen instructions.  
**Note:** If sensors fail to detect the gas, or cannot be spanned, repeat the calibration. If the problem persists, replace the sensor.
7. Remove the calibration cap; the detector starts purging, and the slots LEDs flash amber clockwise. After the purge is complete, the detector is back to the regular mode.

## Calibrate the Detector via DC App

1. Turn On the BW Flex Series detector and wait a few minutes to sensors warm up.
2. In your mobile device, open the **Device Configurator** app and pair with the detector. For pairing details go to See "Bluetooth Pairing" on page 13 for more information.
3. In your mobile device, tap on the Menu button and then select **Remote Calibration**
4. Tap **Calibration**, the IntelliFlash flashes amber to indicate the calibration process has started.

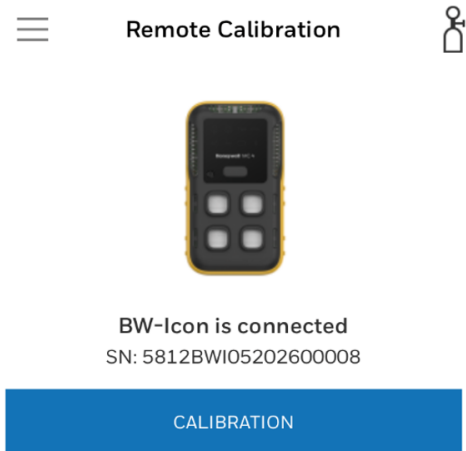

**Note:** If sensors fail to detect the gas, or cannot be spanned, repeat the calibration. If the problem persists, replace the sensor.

5. Enter the **Operator Name**, and then Tap **START**. The detector will start Zero Calibration; the IntelliFlash flashes amber.

A screenshot of the 'Operator Name' input screen in the DC App. At the top, there is a progress indicator with three circles, where the second circle is highlighted. Below this is a white box with the title 'Operator Name' and the text 'Please enter your name for this calibration. It will appear in the calibration report.' Below the text is a text input field containing the word 'User'. At the bottom of the screen are two buttons: a white button with 'CANCEL' in blue and a blue button with 'START' in white.

6. After the Zero calibration is completed, place the cap over the detector, and then press down on both tabs to snap it into place.

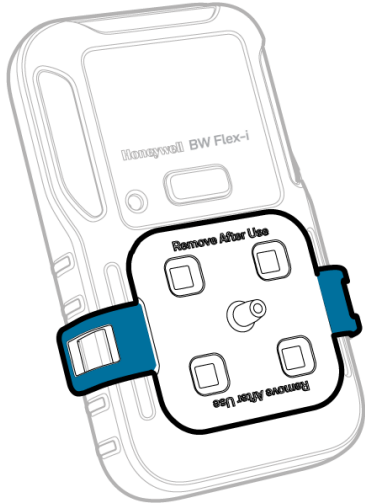

7. Attach the hose.

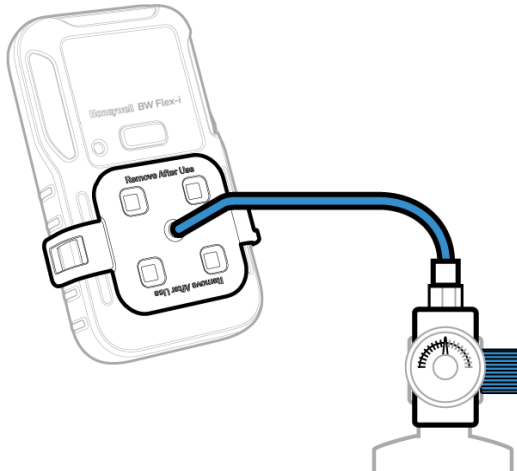

8. use any of the following three ways to select the gas cylinder, and then click **START**.

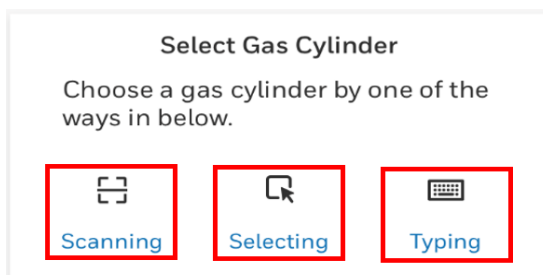

**Scanning:** Scan the bar code from the cylinder

**Selecting:** Choose the Last Time User cylinder information

**Typing:** Manual input of the gas concentration

9. Select the sensor that you want to calibrate and then tap **START**.

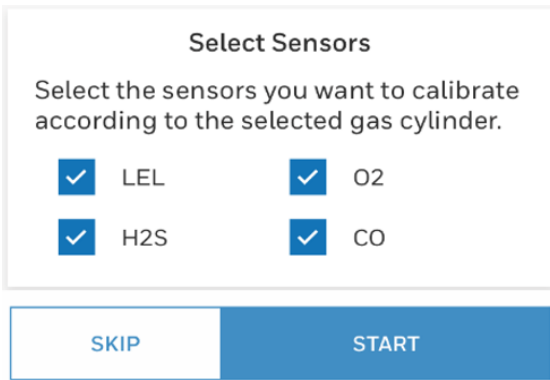

10. Open the cylinder valve by turning the pressure regulator knob counterclockwise. Follow onscreen instructions to know when to apply gas. The IntelliFlash lights amber.

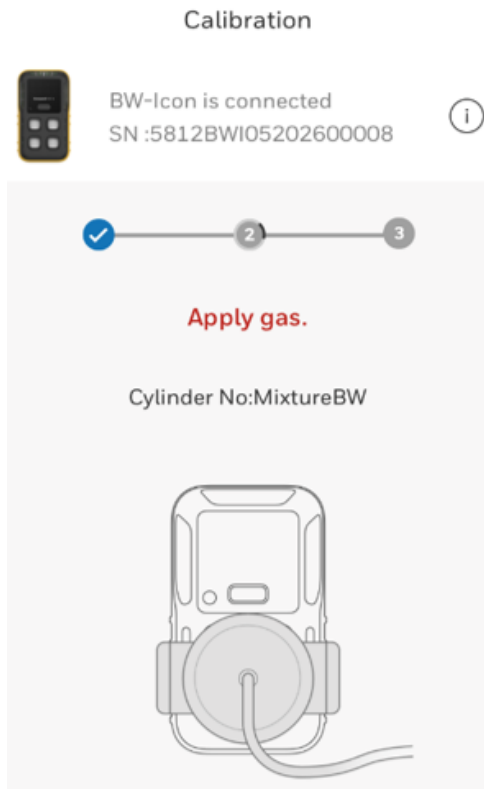

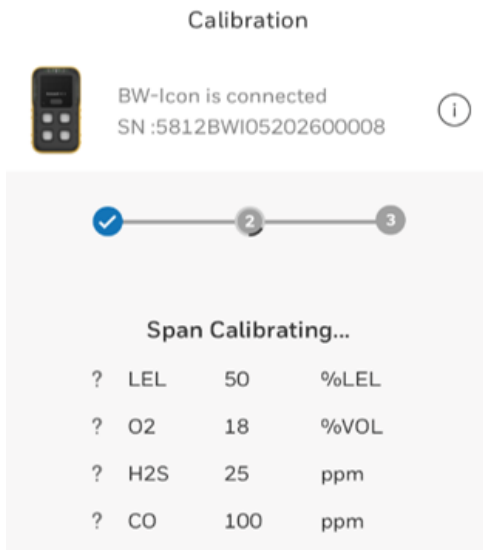

- After calibration is complete, a report is displayed. Tap the Return Arrow button to exit the report and go back to the remote calibration main screen.

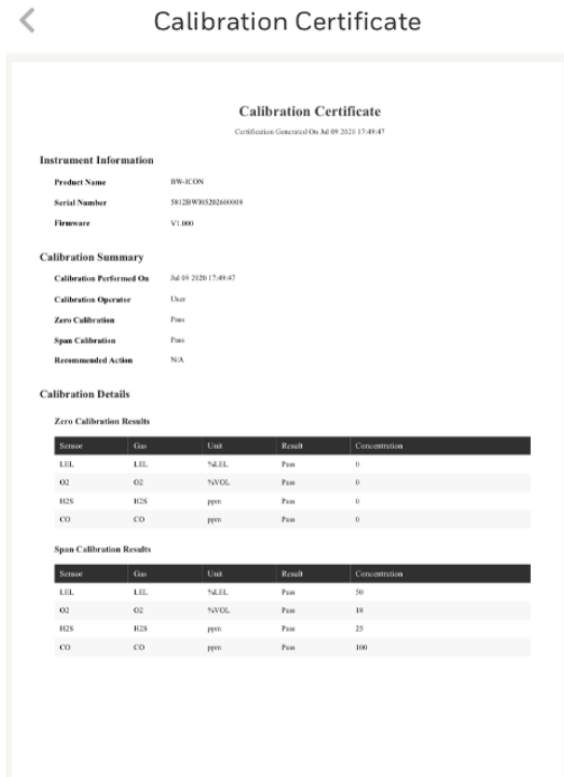

The detector will start purge, and the slots LEDs will flash amber clockwise. After purge is completed, the detector will go to the regular mode.

- Remove the hose and the calibration cap.

## Calibrate the detector via the SSDC

Calibrate the BW Flex Series via the Safety Suite Device Configurator (SSDC) software . You can download SSDC from: [https://explore.honeywell.com/safety\\_suite\\_device\\_configurator.html](https://explore.honeywell.com/safety_suite_device_configurator.html)

1. Turn On the BW Flex Series and wait a few minutes to sensors warm up.
2. Connect the detector to the PC via the IR link.
3. Log in to SSDC with an authorized user account. For further information, refer to the SSDC User Manual.
4. Click on the **Device View** tab, the SSDC scans for connected devices or you can click Refresh to browse manually.

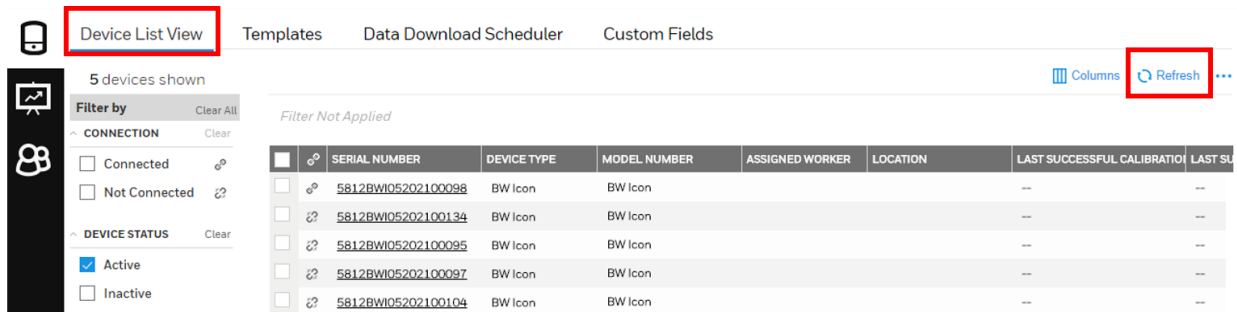

	SERIAL NUMBER	DEVICE TYPE	MODEL NUMBER	ASSIGNED WORKER	LOCATION	LAST SUCCESSFUL CALIBRATION	LAST SU
<input type="checkbox"/>	5812BW105202100098	BW Icon	BW Icon			--	--
<input type="checkbox"/>	5812BW105202100134	BW Icon	BW Icon			--	--
<input type="checkbox"/>	5812BW105202100095	BW Icon	BW Icon			--	--
<input type="checkbox"/>	5812BW105202100097	BW Icon	BW Icon			--	--
<input type="checkbox"/>	5812BW105202100104	BW Icon	BW Icon			--	--

5. Select the connected detector and then click **Start Bump/Cal.**
6. In the Start Bump/Calibration Test window, do the following:
  - Select **Calibration**;
  - Select the sensor. You can modify the default values;
  - Click **START TEST**
  - Wait for several seconds. The detector starts Zero Calibration,
2. After Zero Calibration is complete, place the cap over the detector, and then press down on both tabs to snap it into place.

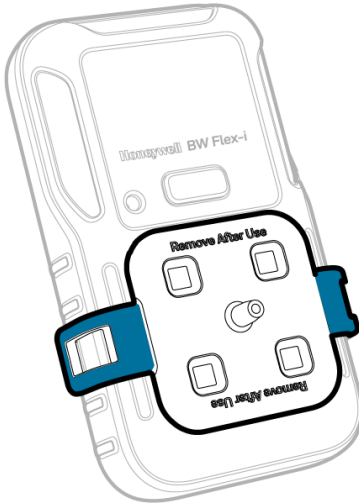

3. Attach the hose.

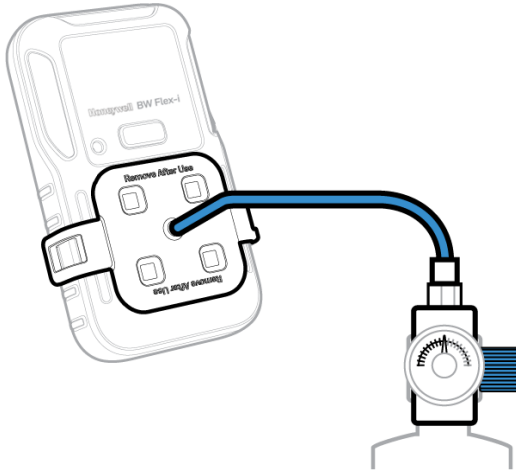

4. Follow onscreen instructions.

Start Bump/Cal Test ✕

Please select the parameters to set

Bump Test  Calibration

<input checked="" type="checkbox"/> IR-LEL Sensor GAS VALUE <input type="text" value="50.0"/> %LEL <small>only numbers are allowed between 10 - 100</small> BUMP THRESHOLD <input type="text" value="40"/> % <small>only numbers are allowed between 40 - 95</small>	<input type="checkbox"/> O2 Sensor GAS VALUE <input type="text" value="18.0"/> %VOL <small>only numbers are allowed between 5 - 25</small> BUMP THRESHOLD <input type="text" value="80"/> % <small>only numbers are allowed between 80 - 95</small>
<input type="checkbox"/> H2S Sensor GAS VALUE <input type="text" value="25.0"/> ppm <small>only numbers are allowed between 10 - 100</small> BUMP THRESHOLD <input type="text" value="40"/> % <small>only numbers are allowed between 40 - 95</small>	<input type="checkbox"/> CO Sensor GAS VALUE <input type="text" value="100.0"/> ppm <small>only numbers are allowed between 35 - 500</small> BUMP THRESHOLD <input type="text" value="40"/> % <small>only numbers are allowed between 40 - 95</small>

7. Apply span gas when the sensor slot LEDs start flashing. Span calibration starts after the detector detects gas. The four sensor slots LEDs flash blue clockwise. After the Span calibration is completed, the LEDs are solid green if calibration passed, or red if failed. **Note:** If sensors fail to detect the gas, or cannot be spanned, repeat the calibration. If the problem persists, replace the sensor.
8. Remove the calibration cap. The detector starts purging, and the slots LEDs flash in amber clockwise. After the purge is complete, the Detector is back to the regular mode.

# Bump Test

The detector can be tested in four ways:

- Via the detector's menu.
- Via the Safety Suite Device Configurator (SSDC) software on a computer.
- Via the Device Configurator (DC) app on a mobile Detector.
- Via the IntelliDoX Docking Module. For further reference see the *IntelliDoX User Manual*.



## CAUTION

- Move to a normal atmosphere (20.9% v/v O<sub>2</sub>) that is free of hazardous gas.
- Honeywell recommends bump testing the sensors before each day's use to confirm their ability to respond to gas by exposing the Detector to a gas concentration that exceeds the alarm setpoints. Manually verify that the audible and visual alarms activate.

### Details for Bump Test and maintenance:

- Recommendations for initial checking of the equipment on a routine basis including the maximum time interval between calibrations.
- The combustible sensor is factory calibrated to 50% LEL methane. If monitoring a different combustible gas in the % LEL range, calibrate the sensor using the appropriate gas.



## Bump Test via the Menu

Apply gas from a cylinder to the sensors manually through the calibration cap, and using the detector's menu.

1. Turn On the BW Flex Series and Wait a few minutes to sensors warm up.
2. Double press the button to enter the menu.
3. Hold the button to enter the bump test, then the sensor slot LED starts flashing blue.
4. Place the cap over the detector, and then press down on both tabs to snap it into place.

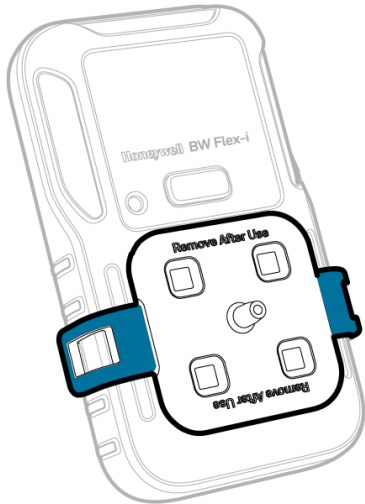

5. Attach the hose.

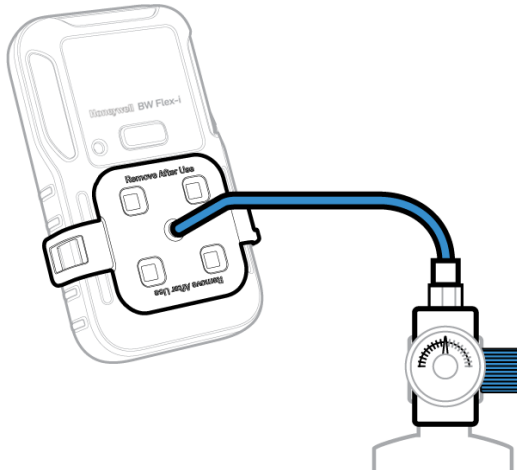

6. Apply span gas when the sensor slot LEDs start flashing. The bump test starts after the BW Flex Series detects gas. The four slots LEDs flash blue clockwise. After the bump test is completed, the LEDs are solid green if calibration passed, or red if failed.
7. Remove the calibration cap; the detector starts purging, and the sensor slots LEDs flash in amber clockwise. After the purge is complete, the detector is back to the regular mode.

## Bump Test via SSDC

Apply gas from a cylinder to the sensors manually through the calibration cap, and using the Safety Suite Device Configurator (SSDC) software on a personal computer (PC). You can download SSDC from: [https://explore.honeywell.com/safety\\_suite\\_device\\_configurator.html](https://explore.honeywell.com/safety_suite_device_configurator.html)

1. Turn On the BW Flex Series. Wait a few minutes to sensors warm up.
2. Connect the detector to the PC via the IR link.
3. Log in to SSDC with an authorized user account. For further information, refer to the *SSDC User Manual*.
4. Click the **Device View** tab, the SSDC scans for connected devices, or you can click Refresh to browse manually.

	SERIAL NUMBER	DEVICE TYPE	MODEL NUMBER	ASSIGNED WORKER	LOCATION	LAST SUCCESSFUL CALIBRATION	LAST SUCCESFUL CALIBRATION
<input type="checkbox"/>	5812BWI05202100098	BW Icon	BW Icon			--	--
<input type="checkbox"/>	5812BWI05202100134	BW Icon	BW Icon			--	--
<input type="checkbox"/>	5812BWI05202100095	BW Icon	BW Icon			--	--
<input type="checkbox"/>	5812BWI05202100097	BW Icon	BW Icon			--	--
<input type="checkbox"/>	5812BWI05202100104	BW Icon	BW Icon			--	--

5. Select the connected detector and then click **Start Bump/Cal**.
6. In the Start Bump/Calibration Test window, do the following:
  - Select Bump
  - Select the bump test sensor. You can modify the default values
  - Click **START TEST**

Please select the parameters to set

Bump Test  Calibration

IR-LEL Sensor

GAS VALUE: 50.0 %LEL  
only numbers are allowed between 10 - 100

BUMP THRESHOLD: 40 %  
only numbers are allowed between 40 - 95

O2 Sensor

GAS VALUE: 18.0 %VOL  
only numbers are allowed between 0 - 25

BUMP THRESHOLD: 80 %  
only numbers are allowed between 80 - 95

H2S Sensor

GAS VALUE: 25.0 ppm  
only numbers are allowed between 10 - 100

BUMP THRESHOLD: 40 %  
only numbers are allowed between 40 - 95

CO Sensor

GAS VALUE: 100.0 ppm  
only numbers are allowed between 35 - 500

BUMP THRESHOLD: 40 %  
only numbers are allowed between 40 - 95

**START TEST**

7. Place the cap over the detector, and then press down on both tabs to snap it into place.

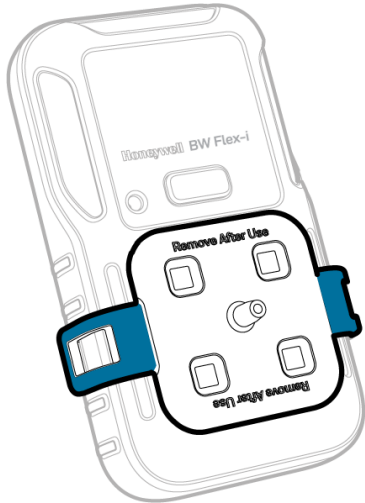

8. Attach the hose.

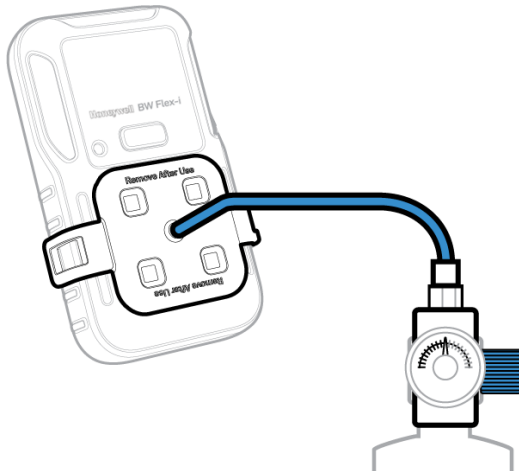

9. Apply span gas when the sensor slot LEDs start flashing. The bump test starts after the BW Flex Series detects gas. The four sensor slots LEDs flash blue clockwise. After the bump test is completed, the LEDs are solid green if calibration passed, or red if failed.

**Note:** If sensors fail to detect the gas, or cannot be spanned, repeat the bump test. If the problem persists, replace the sensor.

10. Remove the calibration cap. The detector starts purging, and the slots LEDs flash in amber clockwise. After the purge is complete, the Detector is back to the regular mode.

11. Attach the hose.

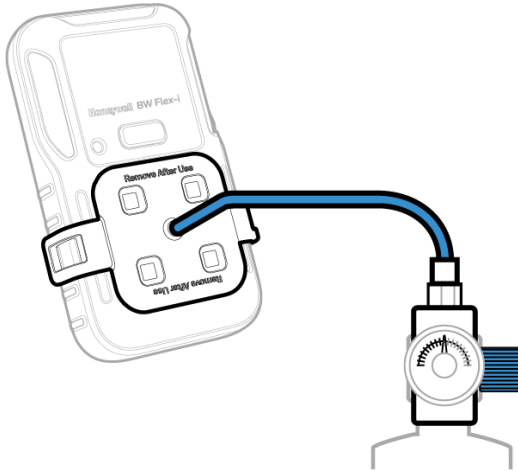

12. In the Input Gas level screen, check the sensor that you want to test and enter the Span gas concentration, and then tap **START**.
13. Open the cylinder valve by turning the pressure regulator knob counterclockwise. The Zero process starts and a message is displayed when succeeded.
14. Follow onscreen instructions to know when to apply gas and when the bump test process is complete.  
**Note:** If sensors fail to detect the gas, or cannot be spanned, repeat the bump test. If the problem persists, replace the sensor.
15. The process is complete when the results are displayed on your mobile device. You can now remove the cap by pulling on the tabs.

## Bump Test via DC

Apply gas from a cylinder to the sensors manually through the calibration cap, and using the Device Configurator (DC) app on a mobile device.

1. Turn On the BW Flex Series. Wait a few minutes to sensors warm up.
2. In your mobile device, open the Detector Configurator app, and pair with the detector. For details, go to See "Bluetooth Pairing" on page 13 for more information.
3. In your mobile device, tap on the Menu button and then select **Bump Test**.
4. Enter the **Operator Name**, and then Tap **Save**. The IntelliFlash LED flashes amber to indicate the bump test process has started.
5. Place the cap over the detector, and then press down on both tabs to snap it into place. Wait a few minutes to sensors warm up.

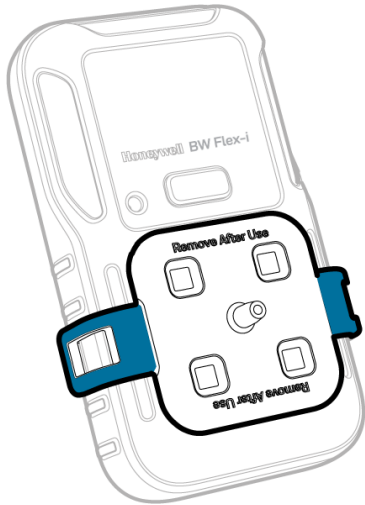

6. Attach the hose.

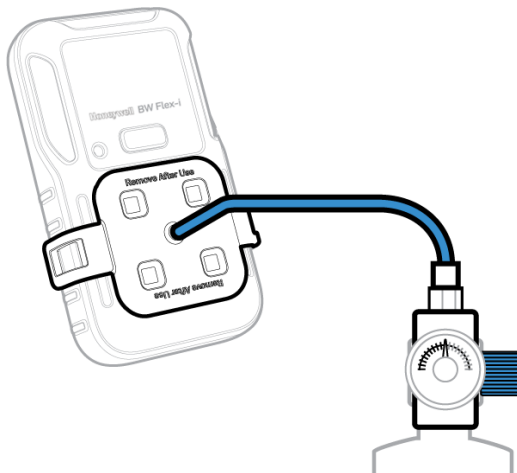

7. In the Input Gas level screen, check the sensor that you want to test and enter the Span gas concentration, and then tap **START**.
8. Open the cylinder valve by turning the pressure regulator knob counterclockwise. The Zero process starts and a message is displayed when succeeded.
9. Follow onscreen instructions to know when to apply gas and when the bump test process is complete.

**Note:** If sensors fail to detect the gas, or cannot be spanned, repeat the bump test. If the problem persists, replace the sensor.

10. The process is complete when the results are displayed on your mobile device. You can now remove the cap by pulling on the tabs.

## Force Calibration and Bump

Force Calibration has a higher priority than Force Bump. If you perform Force Calibration, there is no need to execute the Force Bump again.

You can execute a Force Calibration/Bump via four methods: IntelliDoX docking module, SSDC, DC app, and detector's menu.

Force Calibration/Bump via the IntelliDoX is executed automatically by the docking module.

To execute the Force Calibration/Bump via the SSDC, connect the detector to a computer and follow SSDC onscreen instructions.

To execute the Force Calibration/Bump via the DC app, pair the detector to the mobile phone and follow onscreen instructions.

To execute the Force Calibration/Bump via the detector's menu, enter the calibration/bump menu and when **Cal Now/Bump Now** is displayed, press and hold the button and within 60s you can enter to the flow of cal/bump.

## Zero Calibration



Over time and through use, the sensor baseline at zero exposure may drift from the manufacturer's baseline. For optimal performance Honeywell recommends that you zero the sensors periodically. Only zero calibrate the sensor in fresh air.

1. Double press the button to enter the menu.
2. Single press to switch to ZERO CAL.
3. Press and hold the button to execute the Zero Calibration.

Zero calibration starts automatically, and the sensor LEDs light clockwise in blue.

After Zero calibration passes, "ZERO PASS" is displayed, the sensor LEDs light green for 5 seconds, the sound alarm beeps, and then the detector is back to the regular mode.

## Capture Real Time Reading

1. Pair your BW Flex Series with a mobile device.
2. In your mobile device, open the **Device Configurator** app.
3. Tap **Menu** 
4. Tap **Measurements** .
5. Tap **Start Recording**.

## Configure the detector Settings via DC

1. Pair the BW Flex Series with the Device Configurator App on your mobile device.
2. Tap the menu button ☰
3. Tap **Detector Setup** ⚙️
4. Tap Download, to get the configuration table.

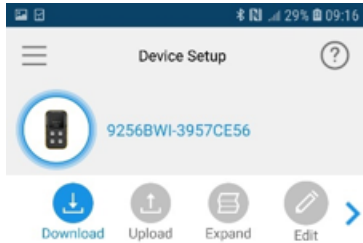

5. Tap **Edit** to change the settings, and then tap **Upload** to apply them.





# 3 Maintenance

## Clean the Detector

Clean the detector using a soft cloth with a water-based or non-alcoholic cleaner. Other types of cleaners, solvents, and lubricants can contaminate and cause permanent damage to the detector sensors.

## Charge the Battery

You can charge the battery via an IntelliDox docking module, the charger adaptor & USB Charger, and the Cradle Charger.

### Note:

The Li-ion battery may require 5 hours to full capacity. The time needed to charge will increase if the Detector is activated. The detector may be warm during charging; this is normal. To preserve the life of the battery, deactivate the Detector when not in use.

The battery operating temperature is  $-40^{\circ}\text{C}$  to  $+60^{\circ}\text{C}$ .



### WARNING

The Honeywell BW™ Flex Series uses a Li-ion battery that may present a risk of fire or chemical burn hazard if misused. Do not disassemble, heat above  $100^{\circ}\text{C}$ , or incinerate.



### CAUTION

- To avoid personal injury and property damage, adhere to the following:
- Charge the battery immediately when the Detector emits a low battery alarm.
- Charge the battery in a safe area that is free of hazardous gas in a temperature range from  $0-45^{\circ}\text{C}$ .
- Charge the battery using Honeywell charger adapters designed for this Detector only. Do not use any other charger adapters. Failure to adhere to this caution can lead to fire and explosion.

- If replacing the battery, use only approved Li-ion polymer cells that are available through Honeywell. User of any other cell can cause fire and explosion.



- Dispose of used Li-ion cells immediately. Do not disassemble and do not dispose of in fire. Do not mix with the solid waste stream. Spent batteries must be disposed of by a qualified recycler or hazardous materials handler.
- Keep Li-ion cells away from children.

## Battery Capacity Indicator

Status	Indication or Alarm	Duration with LEL sensor	Duration with LEL IR sensor
Normal	Static 2-bar battery icon. The Inteliflash flashes green.	>5h	>12h
Normal	Static 1-bar battery icon. The Inteliflash flashes green.	≤5h	≤12h
Battery low	Static empty battery icon. Display exclamation mark instead of SAFE. The IntelliFlash flashes amber.		≤1h
Battery critical	Flash empty battery icon. The IntelliFlash flashes amber, the Alarm LEDs flashes red alternatively. The detector beeps and vibrates.		20min

## Battery Icons

Status	Percentage	Indication or Alarm
Charging	Less than 100%	
Fully charged	100%	
Depleted	0%	
Can't charge	0 %	

### Note when charging with an IntelliDoX:

The detector turns off automatically if the communication with the IDOX is broken for more than 5 mins. For further information, refer to the *IntelliDoX user Manual*.

## Charge the battery via the USB Charger

1. Press and hold the button to deactivate the detector.
2. Plug the USB charger into an USB port.
3. Attach the charging adapter to the charging Port.



Battery charging when the detector is OFF.



Battery charging when the detector is ON.

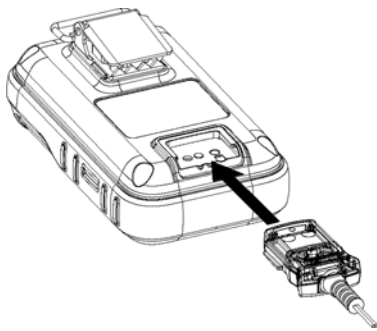

## Charge the battery via the Cradle Charger

1. Deactivate the detector.
2. Insert the detector into the detector bay and press down firmly on the detector to ensure contact between the detector and the contact pins. The detector can be activated during charging.
3. After charge is complete, the full battery icon is displayed .
4. Remove the detector.



Note: For further information, refer to the *Cradle Charger User Manual*.

# Update Firmware

The firmware can be updated via an IntelliDoX Docking Station (see the *IntelliDoX user Manual*), SSDC, or Device Configurator app.

## Update Firmware via DC

Update the firmware via the Device Configurator app on a mobile device.

1. Open the Device Configurator app on your mobile device and pair it with your detector.
2. Tap **Menu** ☰
3. Tap **Firmware** 📱
4. Tap **Update**

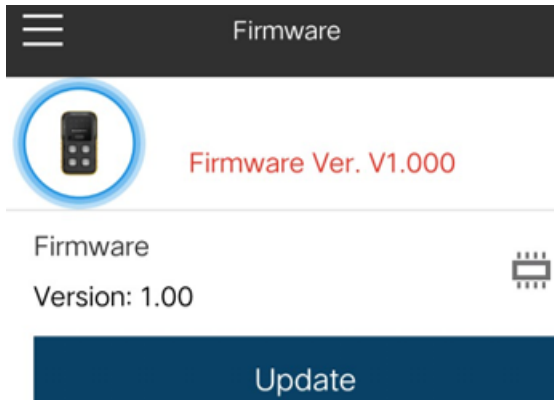

5. Tap **YES** to start the Firmware update, and wait until the "Update Successfully" system message is displayed. The detector goes to the Regular mode.

## Update Firmware via SSDC

1. Connect the detector to Safety Suite Device Configurator via IR Link or Bluetooth
2. Select the detector in the Device List to enter the configuration page
3. Safety Suite Device Configurator checks new firmware automatically after it connects to the Internet. The UPDATE is available when there is a new firmware release. Click UPDATE to start the firmware update.

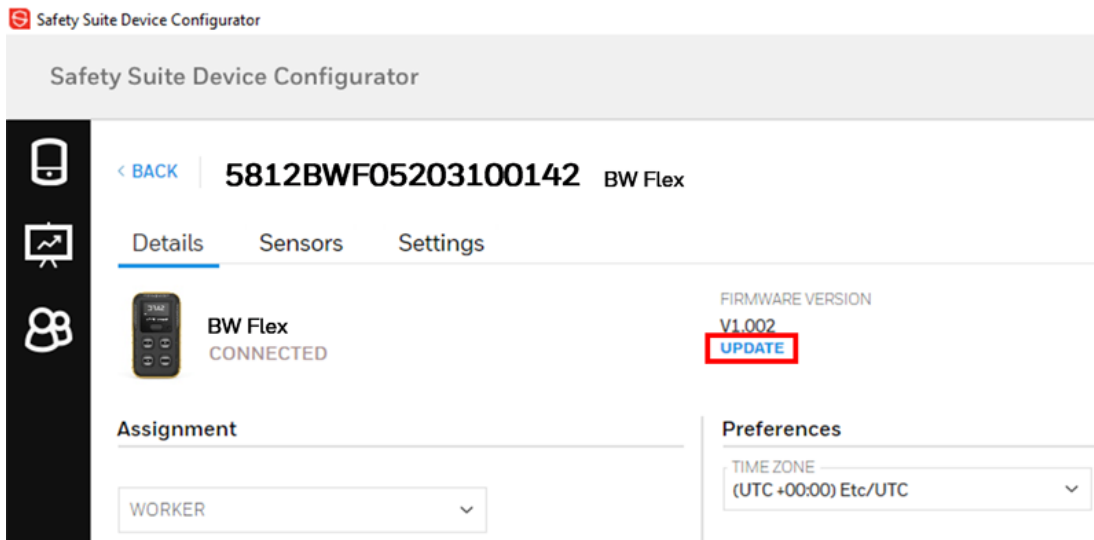

4. Click on the notifications icon on the top right to see the status and wait for an update successfully.

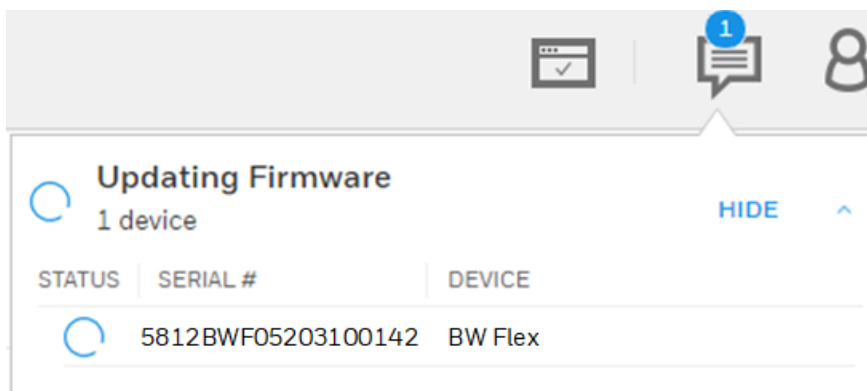

## Replace the Belt Clip or Klick Fast Stud

If the belt clip or Klick Fast Stud is damaged or loose, replace it with a new one. Insert a screwdriver through the hole in the clamp and loosen the screw to detach the clip. Put a new clip or Klick Fast Stud in place and fasten it.

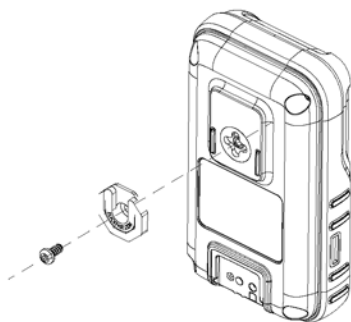

# Replace the Sensor Filter

If the sensor filter is dirty or damaged, please replace it with a new one.

1. Loosen the four screws on the back of the detector to separate the front enclosure.



2. Remove the sensors inserted in the front enclosure.

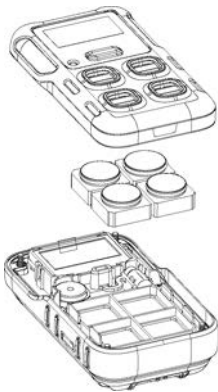

3. Remove the sensor filter from the inside of the front enclosure.

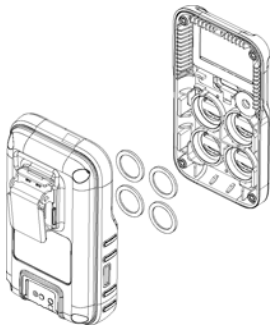

4. Place a new filter in place.
5. Reassemble the detector in the reverse order. Compress front enclosure and back enclosure. Use the screwdriver vertically to fasten the four screws with 3kgf.cm torque first and then use 5kgf.cm torque to fasten the four screws again.

# Replace a Sensor

If the sensor is faulty, please replace it with a new one.

1. Loosen the four screws on the back of the detector to separate the front enclosure.

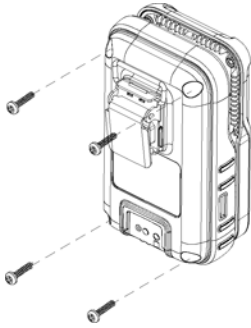

2. Remove the sensor inserted in the front enclosure.

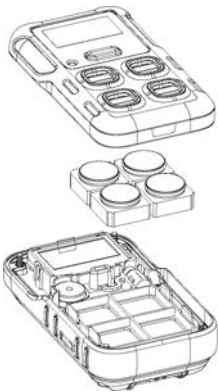

3. Put the new sensor in the correct sensor slot and notice the sensor's unfilled corner face to the sensor frame's unfilled corner.
4. Reassemble the detector in the reverse order. Compress front enclosure and back enclosure. Use the screwdriver vertically to fasten the four screws with 3kgf.cm torque first and then use 5kgf.cm torque to fasten the four screws again.



## CAUTION

Improper re-assembly of the BW Flex series detector could lead to damage and loss of ingress protection. An improper paste of the filter could lead to loss of ingress protection. Installing the sensor in the wrong slot would cause a sensor fault alarm (error 4006) or a wrong slot alarm (error 4004).





# 4 Additional Information

## Sensor Poisons and Contaminants

Several cleaners, solvents, and lubricants can contaminate and cause permanent damage to sensors.

<b>Cleaners and Lubricants</b>	<b>Silicones</b>	<b>Aerosols</b>
Brake cleaners	Silicone cleaners and protectants	Bug repellents and sprays
Lubricants	Silicone based adhesives, sealants, and gels	Lubricants
Rust inhibitors	Hand/body and medicinal creams that contain silicone	Rust inhibitors
Window and glass cleaners	Tissues containing silicone	Window and glass cleaners
Dish soaps	Mold releasing agents	
Citrus based cleaners	Polishes	
Alcohol based cleaners		
Hand sanitizers		
Anionic detergents		
Methanol (fuels and antifreezes)		

## Sensor Specifications

Sensor	Measuring Range	Resolution	Measuring Unit	Working Temperature
CO	0-2000 ppm	1 ppm	ppm, mg/m <sup>3</sup> , μmol/mol	-40°C to +60°C
H <sub>2</sub> S	0-200 ppm	1/0.1ppm	ppm, mg/m <sup>3</sup> , μmol/mol	-40°C to +60°C
SO <sub>2</sub>	0-150ppm	0.1ppm	ppm, mg/m <sup>3</sup> , μmol/mol	-40°C to +55°C
O <sub>2</sub>	0-30% v/v	0.1% VOL	%VOL	-40°C to +60°C
LEL IR	0-100% LEL CH <sub>4</sub>	1% LEL CH <sub>4</sub>	%LEL, % v/v	-40°C to +60°C
LEL	0-100% LEL	1% LEL	%LEL, % v/v	-20°C to +60°C* *Can be operated from -40°C to -20°C

Sensor	SPAN Count Down	Default SPAN Value	Calibration Flow Rate	New Sensor Stabilization Time
CO	60 sec	100ppm	500ml/min	0.5 hour
H <sub>2</sub> S	60 sec	25ppm	500ml/min	0.5 hour
SO <sub>2</sub>	90 sec	20ppm	500ml/min	0.5 hour
O <sub>2</sub>	60 sec	18.0% v/v	500ml/min	24 hours
LEL IR	60 sec	50% LEL CH <sub>4</sub>	500ml/min	N/A
LEL	60 sec	50% LEL	500ml/min	N/A

Sensor	Default Low Alarm	Default High Alarm	Default TWA	Default STEL
CO	35ppm	200ppm	35ppm	50ppm
H <sub>2</sub> S	10.0ppm	15.0ppm	10.0ppm	15.0ppm
SO <sub>2</sub>	2.0ppm	5.0ppm	0.5ppm	1.0ppm
O <sub>2</sub>	19.5% v/v	23.5% v/v	N/A	N/A
LEL IR/LEL	10% LEL	20% LEL	N/A LEL	N/A LEL

# General Specifications

Size	108.2 mm x 61.5 mm x 43.2 mm (4.29 in x 2.44 in x 1.7 in) with Alligator Clip. 108.2 mm x 61.5 mm x 37.8 mm (4.29 in x 2.44 in x 1.49 in) with Klick Fast Stud.
Weight	With Catalytic LEL: 189 g (6.7 oz) with Alligator Clip, 173 g (6.1 oz) with Klick Fast Stud. With IR LEL: 186 g (6.6 oz) with Alligator Clip, 170 g (6.0 oz) with Klick Fast Stud.
Appearance Colour	Amber, Dark Grey
Working Temperature	-40°C to +60°C (-40°F to 140°F) -20°C to +60°C (-4°F to 140°F) with Catalytic LEL sensor.
Working Humidity	5%-95% RH
IP Rating	IP 66/68, 45min@underwater 1.2m
Gas Type	CO, H <sub>2</sub> S, O <sub>2</sub> , SO <sub>2</sub> , Combustible gases*
Display	Monochrome 160X80px, black and white display.
Alarms Condition	Low Alarm, High Alarm, TWA Alarm, STEL Alarm, Negative Drift, Over-Range Alarm, Multi-Alarm.
Visual Alarm	6 Main Alarm LED's and 4 sensor LEDs
Audible Alarm	95 dBA at 10cm
Battery Life	40 days (8 hour per day at room temperature with Catalytic Combustible sensor). 16 hours at room temperature with the LEL sensor.
Event / Datalogging	50 alarm events. Continuous datalogging (45 days at 15 seconds interval and 8 hours per day). User configurable datalogging interval (5 to 60 seconds).
Calibration	Manual calibration from device menu. calibration with Safety Suite Device Configurator or Device Configurator.

\* Ask your Honeywell representative about new sensors availability.

# Troubleshooting

Problem	Cause	Solution
"Battery 0%" message is displayed	Depleted battery	Charge the rechargeable battery pack
Error 1006	Temperature sensor fail	Replace PCBA
Error 1007	Data flash fail	Replace PCBA
Error 1008	BLE fail	Replace PCBA
Error 3001	RTC fail	Replace PCBA
Error 4004	The sensor is in the wrong slot.	Correct the sensor position.
Error 4006	Sensors fail or no communication	Replace the sensor or the PCBA
Need Force Bump. "Bump Now" message is displayed.	Bump overdue and must carry out bump testing before use.	Hold the button for 3 seconds or connect to DC/SSDC or insert to IntelliDoX to start the bump testing; otherwise, the detector will auto power off after 60 secs.
Need Force Calibration "Cal Now" message is displayed.	Calibration overdue and must carry out calibration testing before use.	Hold the button for 3 seconds or connect to DC/SSDC or insert to IntelliDoX to start the Calibration; otherwise, the detector will auto power off after 60 secs.
Detector alarms after start-up sequence	Sensor not stabilized	O <sub>2</sub> sensor: Wait for at least 10 min before power on.
	Sensors require calibration	For the NDIR-CH <sub>4</sub> sensor, please allow 5 minutes following startup for the sensor to warm-up before attempting to calibrate
Detector does not respond when button is pressed	The battery state is critically low, or the battery is depleted.	Charge the rechargeable battery pack
Detector does not respond when button is pressed	Detector is performing operations that do not require user input.	Button operation restores automatically when the operation ends.

<b>Problem</b>	<b>Cause</b>	<b>Solution</b>
Detector Doesn't accurately measure gas.	Sensor(s) require calibration.	Carry out calibration.
	Detector is colder/hotter than gas temperature.	Allow the Detector to attain ambient temperature before use.
	The sensor filter is blocked.	Replace sensor filter
The detector does not alarm.	Alarm setpoints set incorrectly.	Define the alarm setpoint in Detector Configurator.
	Alarm setpoints set to zero.	Define the alarm setpoint in Detector Configurator.
	Detector is in calibration mode.	Complete the calibration procedure.
	Detector is in DC mode.	Stop data communication via a mobile phone.
	Detector is in IR communication.	Stop data communication via IR Link.
The Detector alarms without reason	The sensor was exposed to the target gas.	Detector is operating normally. Use caution in suspected areas. Check the peak gas exposure reading.
	Alarm setpoints are set incorrectly.	Define the alarm setpoint in Detector Configurator.
	Sensors require calibration.	Carry out calibration.
	Missing or faulty sensors.	Replace the sensors.
	Battery temperature is out of acceptable range. 	Move to lower temperature ambient to charge the battery.
Battery indicator doesn't display when charging.	Battery is depleted.	Charge the battery for 8 hours. If the battery indicator doesn't light after charging, contact Honeywell

# DataLogs and Event Logs

## DataLogs

The detector records various information to create a report. The detector is capable of storing 45 days of data at 15 sec interval, 8hrs/day.

When the memory is full, the detector replaces the oldest datalogs with the most recent datalogs.

## Event Logs

The detector records a maximum of 50 gas alarm, maintenance events, and error conditions.

The following event types are recorded:



- 1: Gas high
- 2: Gas low
- 3: Gas STEL
- 4: Gas TWA
- 5: Gas over range
- 6: Gas negative
- 7: Sensor failure
- 8: Multi alarm
- 9: Zeroing
- 10: Spanning
- 11: Bumping
- 12: Disabled

# Alarms





A gas detected event supersedes any other event.

When more than one alarm occurs on one sensor, the highest priority is displayed: Over Range > High > STEL, TWA, Low, Negative.

When more than one sensor alarms, the alarm status is displayed as multi-alarm no matter what kind of gas alarms they are.

Alarm type from high priority to low		Description
Multi-Alarm		"MULTI ALARM" message is displayed. Alarm LEDs alternately flash. Alarmed sensor LEDs flash too. It beeps and vibrates.
Over Limit		"+OL" message is displayed. Alarm LEDs alternately flash. Alarmed sensor LED flashes too. It beeps and vibrates.
High		"HIGH" message is displayed. Alarm LEDs alternately flash. Alarmed sensor LED flashes too. It beeps and vibrates.



Alarm type from high priority to low		Description
STEL		"STEL" message is displayed. Alarm LEDs alternately flash. Alarmed sensor LED flashes too. It beeps and vibrates.
TWA		"TWA" message is displayed. Alarm LEDs alternately flash. Alarmed sensor LED flashes too. It beeps and vibrates.
Low		"LOW" message is displayed. Alarm LEDs alternately flash. Alarmed sensor LED flashes too. It beeps and vibrates.
Negative		"-OL" message is displayed. Intelliflash LED flashes amber. Alarmed sensor LED turns solid red.

# Combustible Sensor Information

The BW Flex device can be installed with either a Non-dispersive Infra-red LEL sensor or a Catalytic type LEL sensors. Furthermore, the catalytic LEL sensors are offered in both filtered and unfiltered variations. Each type of combustible sensors has standard characteristics and limitation which the user should be made aware of.

The following information provided is there to:

- Enable you to identify the type of combustible sensor which is installed within your device, i.e., IR, Catalytic filtered, or unfiltered.
- Provide you with a basic relative response of the IR sensor to other common combustible gases.
- Provide you with a basic list of detectable gases for both catalytic filtered and unfiltered sensors.
- Provide a basic of list recommended Correction factors for the Catalytic LEL sensors.

## Identifying Combustible Sensor Type

The type of combustible sensor may be determined by the model number printed on the Certification / serial number label on the rear of the device, as shown in the following example.

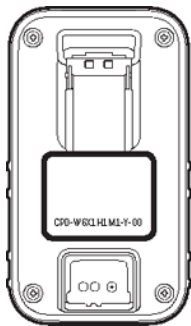

The model number should look like "CPD-W6X1H1M1-Y-00," the type of combustible sensor is identified by the 4th and 5th characters; in this case, "W6".

Use the following table to identify your particular sensor type:

Combustible Sensor option from the model number	Sensor Type
W5	NDIR Combustible
W6	Filtered Catalytic Combustible
W7	Un-filtered Catalytic Combustible

## Non-Dispersive Infrared (NDIR) sensor Relative Response

The BW Flex NDIR LEL sensor is optimized to see methane. While the unit can detect and respond to other combustible gases listed in the below table, the readings' accuracy may be inconsistent. If the primary need is to detect a specific combustible gas other than methane, please contact Honeywell to discuss an alternative product.

Gas <sup>1</sup>	Expected IR LEL response at 20% LEL target gas
Methane	20% LEL
Propane	28% LEL to 56% LEL
Butane	28% LEL to 56% LEL
Pentane	31% LEL to 62% LEL
Hexane	20% LEL to 48% LEL
Methanol <sup>2</sup>	40%LEL to 80% LEL
Ethanol <sup>2</sup>	21% LEL to 42% LEL
Hydrogen	No response
Acetylene	No response

<sup>1</sup>For any gases not listed, please contact Honeywell to find the best solution for your application.

<sup>2</sup>Please use caution when using the BW Flex Series around Methanol and Ethanol. The BW Flex Series CO sensor may become inhibited by prolonged exposure to concentrations of Methanol and Ethanol thus causing the unit to alarm. This condition can last up to 12 hours before the CO sensor recovers to normal levels.

## Filtered and Unfiltered Catalytic Bead Combustible (LEL) Sensor Information

Honeywell BW Flex multi-gas detectors are offered with both filtered and unfiltered combustible gas (LEL) sensors. The filtered LEL sensor provides enhanced resistance to airborne sensor poisons such as volatile silicone vapors and high hydrogen sulfide gas concentrations. Due to some molecules' physical size, the filtered LEL sensor is not typically suitable for the detection of some compounds, including complex hydrocarbons, alcohols, ketones, and esters. The filtered LEL sensor is suitable for detecting less complex molecules, including C1 to C6 hydrocarbons, hydrogen, and acetylene.

For applications requiring the detection of more complex compounds, select a detector with an unfiltered LEL sensor.

Consult the following chart for assistance in selecting a suitable combustible sensor.

Explosive Gas/Vapour	Detectable by Non-Filtered LEL Sensor	Detectable by Filtered LEL Sensor
Hydrogen (H <sub>2</sub> )	X	X
Methane (CH <sub>4</sub> )	X	X
Ethane (C <sub>2</sub> H <sub>6</sub> )	X	X
Propane (C <sub>3</sub> H <sub>8</sub> )	X	X
n-Butane (C <sub>4</sub> H <sub>10</sub> )	X	X
n-Pentane (C <sub>5</sub> H <sub>12</sub> )	X	X
n-Hexane (C <sub>6</sub> H <sub>14</sub> )	X	X
n-Heptane (C <sub>7</sub> H <sub>16</sub> )	X	
n-Octane (C <sub>8</sub> H <sub>18</sub> )	X	
n-Nonane (C <sub>9</sub> H <sub>20</sub> )	X	
Methanol (CH <sub>3</sub> OH)	X	
Ethanol (C <sub>2</sub> H <sub>6</sub> O)	X	
Iso-propyl alcohol (C <sub>3</sub> H <sub>8</sub> O)	X	
Acetylene (C <sub>2</sub> H <sub>2</sub> )	X	X
1, 3 Butadiene (C <sub>4</sub> H <sub>6</sub> )	X	X
Carbon monoxide (CO)	X	X
Acetone (C <sub>3</sub> H <sub>6</sub> O)	X	
Methyl ethyl ketone (C <sub>4</sub> H <sub>8</sub> O)	X	
Toluene (C <sub>7</sub> H <sub>8</sub> )	X	
Ethyl acetate (C <sub>4</sub> H <sub>8</sub> O <sub>2</sub> )	X	
Ammonia (NH <sub>3</sub> )	X	X
Cyclohexane (C <sub>6</sub> H <sub>12</sub> )	X	X

Explosive Gas/Vapour	Detectable by Non-Filtered LEL Sensor	Detectable by Filtered LEL Sensor
Gasoline	X	
Ethylene (C <sub>2</sub> H <sub>4</sub> )	X	X
Benzene (C <sub>6</sub> H <sub>6</sub> )	X	

**Note:** This list is not all-inclusive. As combustible sensors are a non-specific sensing technology, it is recommended you verify detection capabilities for any specific compounds.

Catalytic bead sensors are typically not recommended for detection of combustible gases with flash points greater than 37.8° C/100° F.

### Correction Factor for catalytic type combustible LEL sensors

The following table shows the % relative sensitivity of several common detectable gases based on a methane (CH<sub>4</sub>) calibration. This table applies to both Filtered and Unfiltered versions of the catalytic combustible sensors offered in the BW Flex detector.

Gas	Rel Sens	CF Value (vs Methane)
n-Butane	66	1.5
Hydrogen	111	0.90
Methane	100	1
n-Pentane	58	1.7
Propane	61	1.6
Custom		0.1-15

# User Preferences

All of the parameters and options can be configured using the Safety Suite Device Configurator desktop application. An IntelliDox docking station is required to connect a BW Flex Series detector to SSDC. The BW Flex Series communicates with an IntelliDox using infrared signals, and the IntelliDox is connected to the SSDC computer via a USB or network cable. For more information, refer to the IntelliDox manual and Safety Suite Device Configurator manual.

## Sensor Options

As for each sensor, these parameters and options are available.

- **Auto Zero:**  
If enabled, the detector will perform Zero Calibration at start-up. Disabled is the default value.
- **TWA Method:**  
This option is to choose the algorithm between ACGIH and OSHA.
- **Inert Mode:**  
It is used to switch the work mode of the Oxygen sensor. Normal mode is for the atmospheric environment, and the zero reading is between low and high alarm. The Inert mode is for an anaerobic environment, and the zero reading is below the Low Alarm. Normal mode is the default value.
- **ATEX Performance Compliance:**  
If enabled, the blanking zone will be disabled, and the minus reading will be display. Disabled is the default value.
- **Low Alarm Acknowledge:**  
If enabled, the audible alarm can be disabled during a Low Alarm. The vibration, visual indication, and LCD remain enabled. It applies for H<sub>2</sub>S, CO, and LEL sensors only.
- **Cal / Bump Countdown:**  
This countdown is an indication before calibration due. Users can customize how many days before calibration due to start this indication. Disabled is the default value.
- **Bump Threshold:**  
The bump Threshold is the percentage of calibration gas needed to get detected in the bump test.
- **Predictive calibration %:**  
It is an Intelligent EC sensor function. For the predictive calibration, a calculation taking historical measurements such as the temperature, electrolyte concentration, sensitivity, accuracy, and time is considered. Users can set the threshold of sensitivity attenuation for the predictive calibration. 20% is the default value.
- **Sensor Disabled:**  
Disable an unnecessary gas sensor.
- **Calibration Gas Conc:**  
Define the gas concentration for calibration.
- **Low Alarm:**  
Define the threshold at which a low-level alarm is triggered.
- **High Alarm:**  
Define the threshold at which a high-level alarm is triggered.

- **TWA Alarm:**  
Define the threshold at which a TWA alarm is triggered. This parameter is available only for H<sub>2</sub>S and CO.
- **STEL Alarm:**  
Define the threshold at which a STEL alarm is triggered.
- **Calibration Interval:**  
Define how often a calibration should be executed.
- **Bump Interval:**  
Define how often a bump test should be executed.
- **STEL interval:**  
Define the period after which a STEL alarm is triggered. This parameter is available only for H<sub>2</sub>S and CO. The available range is 5 to 15 minutes.
- **Display Decimal:**  
Determine whether to express as an integer or tenths decimal. This parameter is available only for H<sub>2</sub>S.

## Behavior Options

These behavior options are available.

- **3rd. Party Profile:**  
If enabled, the detector can connect to a Motorola device and send real-time data: Disabled is the default value. Only SSDC can set via IR Link.
- **Datalog Download Since Last:**  
If enabled, datalog download in DC, SSDC, IntelliDoX will always download the unsynchronized data to reduce Synchronization Time: Enabled is the default value.
- **Lockout on Self-Test Error:**  
If enabled and a failure occurs during the self-test, the detector deactivates. Disabled is the default value.
- **TWA & STEL Backup:**  
If enabled, when the device is powered down for greater than 2 hours, then STEL/TWA calculations will start freshly. Disabled is the default value.
- **Latching Alarms:**  
If enabled, the gas alarm latches until the user hold the button for 1 second to eliminate. Disabled is the default value.
- **Disable Power Off:**  
If enabled, the detector cannot be deactivated by pressing the button. The user can deactivate the detector by IntelliDoX or disable this feature. Disabled is the default value.
- **Flip Display:**  
If enabled, flip the display. Disabled is the default value.
- **Cal Lock:**  
If enabled, can't carry out calibration manually from the detector. Disabled is the default value.
- **Recurrence Time:**  
If enabled, the bump/cal due to indication will appear at the customized time point. If disabled, the bump/cal due to indication will appear at the same time point of the last bump/cal. Disabled is the default value.

- **Stealth Mode:**  
With this option enabled, the gas detector only vibrates without beeping and flashing when an alarm occurs.
- **Alarm Latch:**  
With this option enabled, when an alarm occurs, the detector continues beeping, flashing, and vibrating for a specified time even after the alarm condition is cleared. To acknowledge a latched alarm, press the button.
- **Time zone:**  
Specify the time zone where the detector is used.
- **Automatically Adjust Clock for Daylight Savings Time:**  
Determine whether to use daylight saving time.
- **Spring Start Time:**  
For daylight saving time, specify the date and time when the spring starts.
- **Fall End Time:**  
For daylight saving time, specify the date and time when the fall ends.



## Replacement Parts

SR-M1-1S	CO sensor, Analog
SR-H1-1S	H <sub>2</sub> S sensor, Analog
SR-X1-1S	Oxygen sensor, Analog
SR-S3-1S	SO <sub>2</sub> sensor, Analog
SR-M2-1S	CO sensor, Digital
SR-H2-1S	H <sub>2</sub> S sensor, Digital
SR-X2-1S	Oxygen sensor, Digital
SR-S4-1S	SO <sub>2</sub> sensor, Digital
SR-W5-1S	LEL IR sensor, Digital
SR-W6-1S	LEL sensor, Digital
SR-DUMM-1S	Dummy sensor
CP-BC1	Back shell, Yellow
CP-BC1B	Back shell, Black
CP-VM-1	Vibration motor
CP-BAT	Battery pack
CP-KF	Klickfast stud
CP-SF2	LCD and Sensor frame
CP-SS	Sensor Membrane(kit of 4)
CP-SS-K1	Sensor membrane(kit of 20)
CP-AG	Alligator Clip
CP-SS-AF-K1	Filters(10pcs)
CP-SCREW-K1	Housing screws(20pcs)
CP-LCD-K1	LCD Kit
CP-FC3	Front enclosure BW Flex-i
CP-FC4	Front enclosure BW Flex4
CP-LBL-3	Sensor label pack
CP-MPCB3	PCBA, BW Flex-i
CP-MPCB4	PCBA, BW Flex4
SR-W7-1S	LEL sensor unfiltered, Digital

## Accessories

CP-AF-K3	External Filter Kit
GA-PA-1-MC5	Mains 5-way charger
CP-USB	USB Charger,5.8V,1A
DX-NEST-CP	IntelliDox nest
DX-CP	IntelliDox
CP-C01-5	5 way cradle charger
CP-TC-1	Calibration cap

# Security Information

This manual provides additional information for the customer and organization related to identification and risk management associated with the use of the system in connected infrastructure. It applies to a system with the following components:

- Safety Suite Detector Configurator
- IntelliDoX Docking Station
- Gas Detection Instruments

Some controls such as custom operating system, encrypted data for firmware updates, and elimination of confidential data from the system (except for gas log files if designated as confidential by the customer) are already built into the system. This manual is focusing on additional controls that could be added by the customer.

## Security considerations for system installation

- To minimize unauthorized external access to the system, Safety Suite Detector Configurator should operate behind a sufficiently robust and current company firewall.
- Ensure virus protection is installed, signature files are up-to-date, and subscriptions are active as per applicable IT policies.
- Allow only digitally signed software from trusted sources to run on PC, where Safety Suite Detector Configurator is installed.
- To minimize the possibility of tampering with docking stations, instruments, and PCs, it is recommended to limit physical access to authorized personnel only.

## Security considerations for instruments equipped with wireless connectivity

- Bluetooth communication is always ON. It cannot be turned OFF by the user.
- If possible pair devices ONLY when in a physically secure area

## System Monitoring

It is highly recommended to perform regular security inspections of the system and review authorized access data.

Honeywell does not represent that the software is compatible with any specific third-party hardware or software other than as expressly specified by Honeywell. The Customer is responsible for providing and maintaining an operating environment with at least the minimum standards specified by Honeywell. The Customer understands and warrants that Customer must implement and maintain reasonable and appropriate security measures relating to the software, the information used therein, and the network environment. This obligation includes complying with applicable cybersecurity standards and best practices including, but not limited to, the Federal Trade Commission consent decrees and other declarations of reasonable and appropriate security measures, the National Institute of Standards and Technology (“NIST”) Cybersecurity Framework and NIST Alerts, InfraGard Alerts, and the United States Computer Emergency Readiness Team (“US-CERT”) Alerts and Bulletins, and their equivalents.

The software is provided “as is” without any express or implied warranties. Honeywell, its affiliated companies, and licensors expressly disclaim any implied warranty of merchantability, warranty of fitness for a particular purpose, and warranty of non-infringement. In no event are

Honeywell, its affiliates, and licensors liable for any loss of data, loss of profit, or any loss or damage, whether direct, indirect, incidental, special, or consequential, however arising, as a result of accessing or using the software. So long as this provision is enforceable in Customer's jurisdiction, the foregoing limitations, exclusions, and disclaimers apply to the fullest extent permitted by law even if any remedy fails of its essential purpose.

# Contact Us

## **Europe, Middle East, Africa**

Life Safety Distribution GmbH

Javastrasse 2

8604 Hegnau

Switzerland

Toll-Free 00800 333 222 44

Middle East +971 4 450 5800

Middle East +971 4 450 5852

(Portable Gas Detection)

gasdetection@honeywell.com

## **Americas**

Honeywell Analytics

405 Barclay Boulevard

Lincolnshire, Illinois.

USA 60069

Toll free: 1-800 538 0363

Tel: +1 847 955 8200

detectgas@honeywell.com

## **Asia Pacific**

Honeywell Analytics Asia Pacific

7F SangAm IT Tower,

434 Worldcup Buk-ro, Mapo-gu,

Seoul 03922, South Korea

Tel: +82 (0) 2 6909 0300

India Tel: +91 124 4752700

analytics.ap@honeywell.com

**Technical Services**

EMEA: HAexpert@honeywell.com

US: ha.us.service@honeywell.com

AP: ha.ap.service@honeywell.com



[www.honeywellanalytics.com](http://www.honeywellanalytics.com)

Rev-A ENG © Tuesday, December 22, 2020