

# Thermo Scientific Orion Star A216 Benchtop and Star A326 Portable pH/RDO/DO Meters

## Reference Guide



Ross and the COIL trade dress are trademarks of Thermo Fisher Scientific, Inc. and its subsidiaries.

AQUAfast, AQUASensors, BOD AutoEZ, ionplus, KNIpHE, LogR, No Cal, ORION, perpHect, PerpHecT, pHISA, pHuture, Pure Water, Sage, ROSS, ROSS Ultra, Sure-Flow, Titrator PLUS, and TURBO2 are registered trademarks of Thermo Fisher Scientific, Inc. and its subsidiaries.

A+, All in One, Aplus, AUTO-BAR, AUTO-CAL, Auto-ID, AUTO-READ, AUTO-STIR, Auto-Test, AutoTraction, CISA, digital LogR, DuraProbe, EZ Startup, ISEasy, Low Maintenance Triode, Minimum Stir Requirement, MSR, NISS, Optimum Results, Orion Dual Star, Orion Star, SAOB, SMART AVERAGING, SMART STABILITY, Star LogR, Star Navigator 21, Stat Face, Triode are trademarks of Thermo Fisher Scientific, Inc. and its subsidiaries.

Guaranteed Success and The Technical Edge are service marks of Thermo Fisher Scientific, Inc. and its subsidiaries.

© 2011 Thermo Fisher Scientific Inc. All rights reserved. All trademarks are the property of Thermo Fisher Scientific, Inc. and its subsidiaries.

The specifications, descriptions, drawings, ordering information and part numbers within this document are subject to change without notice.

This publication supersedes all previous publications on this subject.

# Thermo Scientific Orion Star A216 Benchtop and Star A326 Portable pH/RDO/DO Meters

<b>Chapter 1</b>	<b>Introduction</b> .....	<b>1</b>
<b>Chapter 2</b>	<b>Meter Overview</b> .....	<b>3</b>
	<b>Meter Connections and Inputs</b> .....	<b>3</b>
	<i>Power Source</i> .....	3
	<i>Electrodes and Other Connections</i> .....	4
	<i>Connecting Electrode the Benchtop Meter</i> .....	5
	<b>Meter Display</b> .....	<b>6</b>
	<b>Meter Keypad</b> .....	<b>7</b>
	<b>Meter Maintenance</b> .....	<b>8</b>
<b>Chapter 3</b>	<b>Meter Setup</b> .....	<b>9</b>
	<b>Navigating the Setup Menu</b> .....	<b>9</b>
	<b>Setup Menu Overview</b> .....	<b>9</b>
	<i>pH Channel Menu</i> .....	10
	<i>DO/RDO Channel Menu</i> .....	12
	<i>Settings Menu</i> .....	14
	<i>View Log Menu</i> .....	15
	<i>Diagnostics Menu</i> .....	15
<b>Chapter 4</b>	<b>pH, RmV and ORP Calibration</b> .....	<b>17</b>
	<b>pH Calibration</b> .....	<b>17</b>
	<i>Calibration Editing</i> .....	18
	<b>RmV Calibration</b> .....	<b>18</b>
	<b>ORP Calibration</b> .....	<b>19</b>
<b>Chapter 5</b>	<b>RDO/DO Calibration</b> .....	<b>21</b>
	<b>Air Dissolved Oxygen Calibration</b> .....	<b>21</b>
	<b>Water Dissolved Oxygen Calibration</b> .....	<b>22</b>
	<b>Manual Dissolved Oxygen Calibration</b> .....	<b>23</b>
	<b>Set Zero Dissolved Oxygen Calibration</b> .....	<b>24</b>
<b>Chapter 6</b>	<b>Temperature Calibration</b> .....	<b>25</b>
<b>Chapter 7</b>	<b>Measurement</b> .....	<b>27</b>
<b>Chapter 8</b>	<b>Methods</b> .....	<b>29</b>
	<b>Saving the Current Meter Settings as a New Method</b> .....	<b>29</b>
	<b>Loading an Existing Method</b> .....	<b>29</b>
	<b>Editing, Copying or Deleting an Existing Method</b> .....	<b>30</b>

<b>Chapter 9</b>	<b>Data Storage and Retrieval</b> .....	<b>31</b>
	<b>Data Storage Settings</b> .....	<b>31</b>
	<i>Read Type Selection</i> .....	31
	<i>Computer and Printer Export Settings</i> .....	32
	<i>Data Log Settings</i> .....	32
	<b>Viewing the Calibration Log and Data Log</b> .....	<b>33</b>
	<i>Viewing the Calibration Log</i> .....	33
	<i>Viewing the Data Log</i> .....	33
	<b>Exporting the Data Log to a Computer or Printer</b> .....	<b>34</b>
	<b>Clearing the Data Log</b> .....	<b>35</b>
	<b>Interfacing a Printer</b> .....	<b>36</b>
	<b>Interfacing a Computer</b> .....	<b>36</b>
<b>Chapter 10</b>	<b>Customer Services</b> .....	<b>37</b>
	<b>Meter Errors and Recommended Actions</b> .....	<b>37</b>
	<b>Meter Self Test and Checkout</b> .....	<b>38</b>
	<i>Meter Self Test</i> .....	38
	<i>Meter Checkout (pH)</i> .....	38
	<b>Electrode Stability Test</b> .....	<b>39</b>
	<b>Meter Factory Reset</b> .....	<b>39</b>
	<b>Meter User Reset</b> .....	<b>40</b>
	<b>About Meter</b> .....	<b>40</b>
	<b>Assistance</b> .....	<b>40</b>
	<b>Warranty and Registration</b> .....	<b>40</b>
	<b>Ordering Information</b> .....	<b>41</b>
<b>Chapter 11</b>	<b>Meter Compliance</b> .....	<b>45</b>
	<b>Notice of Compliance</b> .....	<b>45</b>
	<b>WEEE Compliance</b> .....	<b>45</b>
	<b>Declaration of Conformity</b> .....	<b>46</b>
	<b>Meter Specifications</b> .....	<b>47</b>
<b>Appendix 1</b>	<b>Advanced Meter Features</b> .....	<b>51</b>
	<b>Automatic pH Buffer Recognition Feature</b> .....	<b>51</b>
	<i>Testing a pH Electrode for Automatic Buffer Recognition</i> ..	51
	<b>Electrode Condition Icon</b> .....	<b>52</b>
	<b>Multipoint Calibration Curve Feature</b> .....	<b>53</b>
	<b>Dissolved Oxygen Barometric Pressure Compensation</b> .....	<b>53</b>
	<b>Dissolved Oxygen Salinity Correction</b> .....	<b>54</b>

*This page intentionally left blank.*

---

## Chapter 1 Introduction

Thank you for your purchase of the Orion Star A216 benchtop pH/RDO/DO or Star A326 portable pH/RDO/DO meter. These meters are capable of measuring pH, mV, relative mV (RmV), ORP, dissolved oxygen and temperature in °C or °F.

The Orion Star A216 benchtop pH/RDO/DO meters feature

- pH range of -2.000 to 20.000 pH units with 0.1, 0.01 or 0.001 resolution and up to 5 calibration points
- mV, relative mV and ORP range of -2000.0 to +2000.0 mV with 0.1 mV resolution
- Dissolved oxygen range of 0 to 50 mg/L or 0 to 500 % saturation using an RDO optical dissolved oxygen probe with a resolution of 0.1 or 0.01 mg/L and 1 or 0.1 % saturation
- Dissolved oxygen range of 0 to 90 mg/L or 0 to 600 % saturation using a polarographic dissolved oxygen probe with a resolution of 0.1 or 0.01 mg/L and 1 or 0.1 % saturation
- AUTO-READ, continuous (with hold option) and timed measurement modes
- calibration editing
- 2000 point data log
- manual, ready (AUTO-READ) and timed data logging functions
- IP54-rated dust and splash resistant housing

The Orion Star A326 portable pH/RDO/DO meters feature

- pH range of -2.000 to 20.000 pH units with 0.1, 0.01 or 0.001 resolution and up to 5 calibration points
- mV, relative mV and ORP range of -2000.0 to +2000.0 mV with 0.1 mV resolution
- Dissolved oxygen range of 0 to 50 mg/L or 0 to 500 % saturation using an RDO optical dissolved oxygen probe with a resolution of 0.1 or 0.01 mg/L and 1 or 0.1 % saturation
- Dissolved oxygen range of 0 to 90 mg/L or 0 to 600 % saturation using a polarographic dissolved oxygen probe with a resolution of 0.1 or 0.01 mg/L and 1 or 0.1 % saturation
- AUTO-READ, continuous (with hold option) and timed measurement modes
- calibration editing
- 5000 point data log
- manual, ready (AUTO-READ) and timed data logging functions
- IP67-rated dust-proof and waterproof housing

Please read this reference guide thoroughly. Any use outside of these instructions may invalidate your warranty and cause permanent damage to the meter.

*This page intentionally left blank.*

## Chapter 2 Meter Overview

### Meter Connections and Inputs

#### *Power Source*

1. Power adapter (included with benchtop meters, sold separately for portable meters)
  - a. Select the appropriate wall socket plug plate.
  - b. Slide off the clear plastic cover from the plug plate.
  - c. Slide the plug plate into the groove on the back of the power adapter.
  - d. Connect the power adapter to the meter and power outlet.
  
2. Batteries (included with portable meters, sold separately for benchtop meters)
  - a. Select four AA alkaline batteries.
  - b. Confirm that the meter is powered off.
  - c. Remove the battery compartment cover.
    - i. Benchtop meters – push down on the battery compartment tab and lift the battery cover up.
    - ii. Portable meters – loosen the screws holding the battery cover, release the top portion of the battery cover from the meter (use a coin or your finger) and release the bottom portion of the battery cover.
  - d. Orientate the batteries as shown in the battery compartment housing and insert batteries.
  - e. Replace the battery compartment cover. For portable meters – replace the screws.

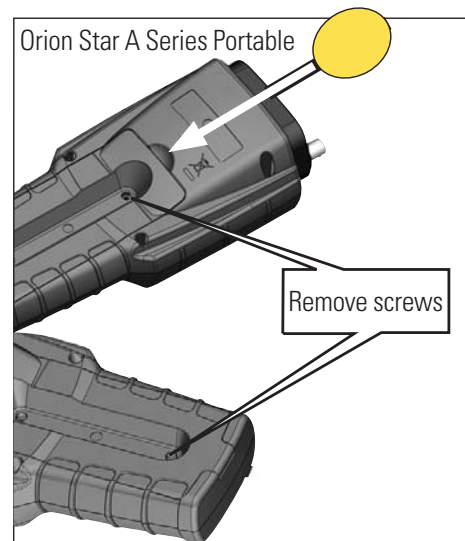
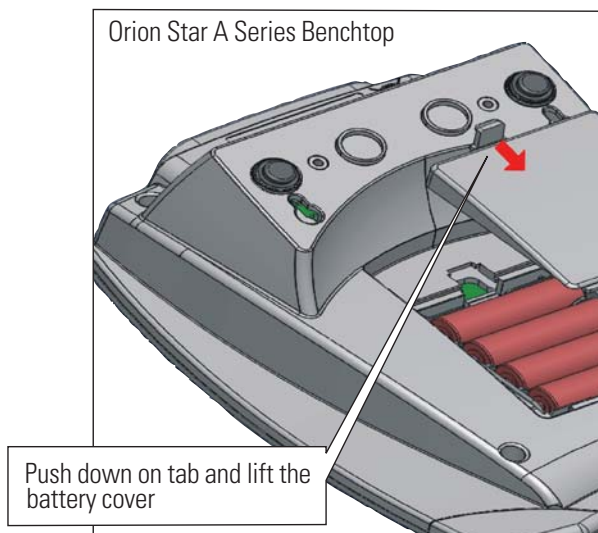



## Electrodes and Other Connections

1. Prepare the pH electrode, RDO optical dissolved oxygen probe, polarographic dissolved oxygen probe and any other applicable electrodes according to the directions in the electrode user guide.
2. Connect the appropriate items as labeled on the meter and as shown in the figure below:

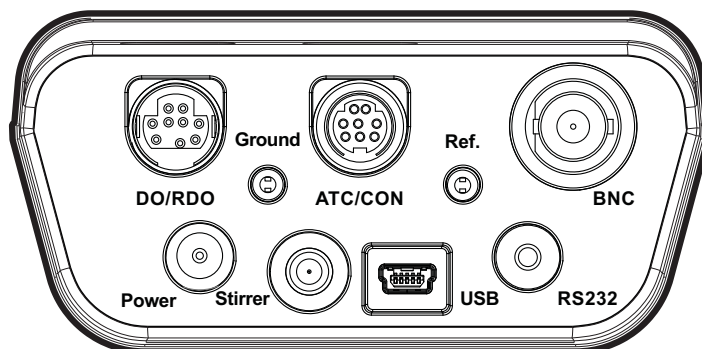

*Star A216 Meter Back Panel*

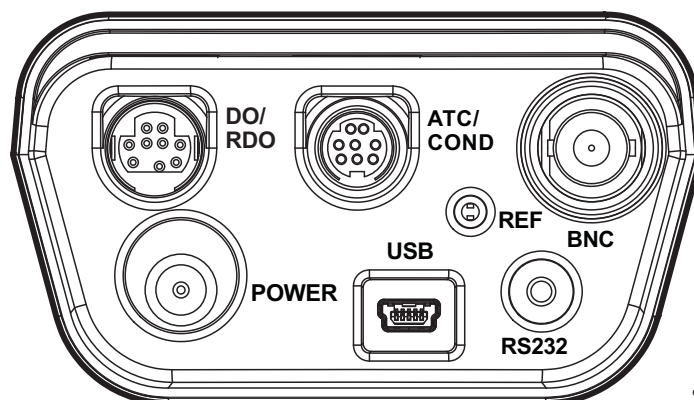

*Star A326 Meter Back Panel*

- BNC – Input for pH electrode or ORP/redox electrode with BNC or waterproof BNC connector.
- REF – Input for reference electrode with standard 2.5 mm pin-tip connector.
- ATC/CON – Input for ATC probe with 8 pin MiniDIN connector.
- Ground – Input for a ground wire with a standard pin-tip connector. *Orion Star A216 benchtop meters only.*
- DO/RDO – Input for RDO optical dissolved oxygen probe or polarographic dissolved oxygen probe with 9 pin MiniDIN connector.
- Power – Input for the power adapter.
- Stirrer – Input for the stirrer probe, Cat. No. 096019. *Orion Star A216 benchtop meters only.*
- USB – Input for the USB cable, used to connect the meter to a printer or computer.
- RS232 – Input for the RS232 cable, used to connect the meter to a printer or computer.



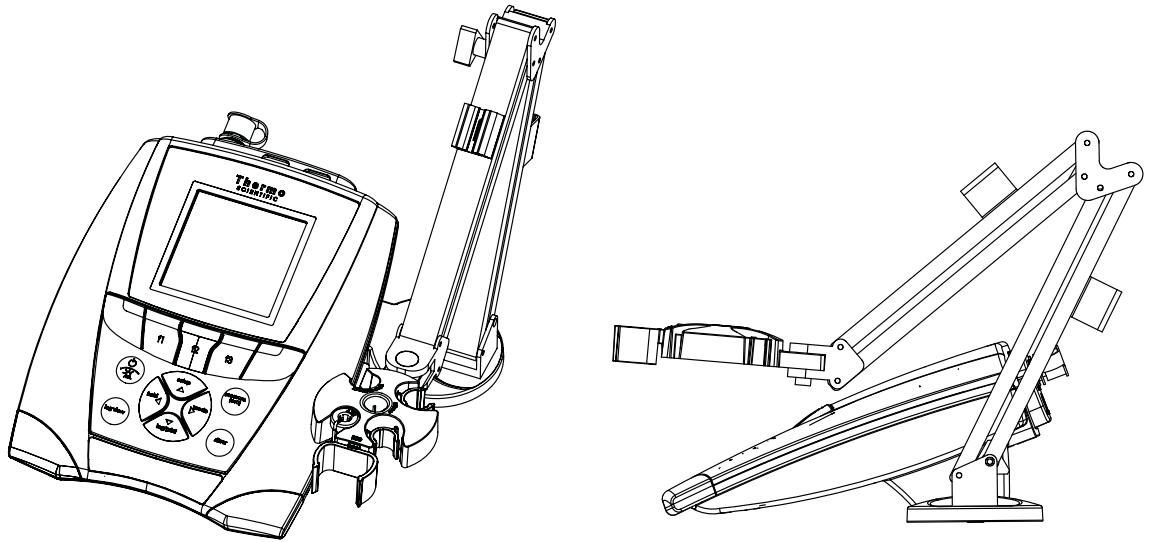













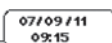







## Connecting Electrode Arm to an Orion Star A Series Benchtop Meter



Orion Star A series benchtop meters include an electrode arm that can be attached to either side of the meter.

1. Unpack the electrode arm and base.
2. Choose the side of the meter to attach the arm.
3. Use a clean surface and turn the meter over.
4. Release the existing screw from the back of the meter.
5. Align the electrode arm base with the circles at the bottom of the meter. The metal post on the electrode arm base should be on the same side as the meter display.
6. Take the screw that was removed and use it to secure the electrode arm base to the meter.
7. Turn the meter over.
8. Place the hole at the bottom of the electrode arm onto the metal post on the electrode arm base.

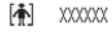
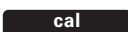
## Meter Display

Display Icon	Description
	Shown when the meter is running on AC power.
	Shown when the meter has batteries installed.
	Indicates data is being sent to a computer or printer.
	Indicates data is being sent to the data log.
	Shown when an alarm is set and the alarm value is reached.
	Indicates the meter is set to be interfaced with a printer or computer via the RS232 port.
	Indicates the meter is set to be interfaced with a printer or computer via the USB port.
	Displays the time and date entered in the setup menu.
	Displays the current temperature based on the temperature probe reading or entered temperature value. Shows the origin of the temperature as MAN (entered temperature) or ATC (temperature probe).
	Shown when  is pressed and the displayed measurement is frozen.
	Indicates a calibration was successfully completed. Icon will blink when the calibration alarm is set and the alarm value is reached.
	Indicates the pH electrode condition as good (two bars), fair (one bar) or bad (slash through it), based on the last saved calibration and measurement stability.
	Indicates a method is in use and the number of the method being used.
	Indicates the type of measurement and determines the type of calibration that will be performed.
	Specifies the stability of the electrode as <b>stabilizing</b> or <b>ready</b> .
	Shown when the meter is in AUTO-READ mode. The  icon will blink while the reading is stabilizing and stop blinking when the reading is stable and the measurement is locked on the display.
	Displays the measurement value based on the last saved calibration and current electrode reading. Units are shown to the right of the value.
	Shows the raw millivolt reading of the electrode. <b>pH mode only.</b>
	Shows the buffer values used for the last saved calibration. <b>pH mode only.</b>
	Shows the barometric pressure measured by the meter ( <b>Auto</b> ) or entered by operator ( <b>Man.</b> ) and used to correct dissolved oxygen measurements. <b>RDO/DO modes only.</b>
	Displays the salinity correction factor used to correct dissolved oxygen measurements. <b>RDO/DO modes only.</b>
	Shows the operator assigned sample ID number.
	Shows the operator assigned user ID number.
	Displays the action that will be performed when <b>f1</b> is pressed.
	Displays the action that will be performed when <b>f2</b> is pressed.
	Displays the action that will be performed when <b>f3</b> is pressed.

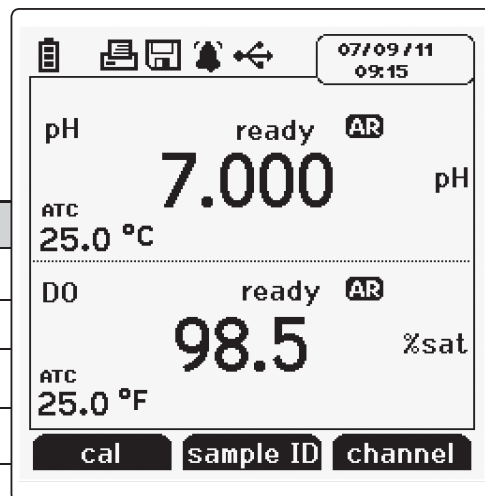

## Meter Keypad

Orion Star A200  
and A300 Series  
Portable Keypad

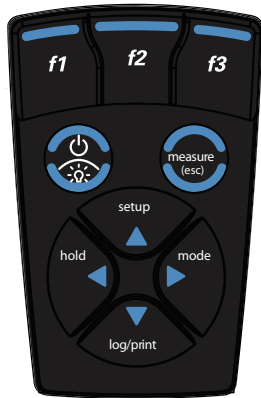

Orion Star A200 Series  
Benchtop Keypad

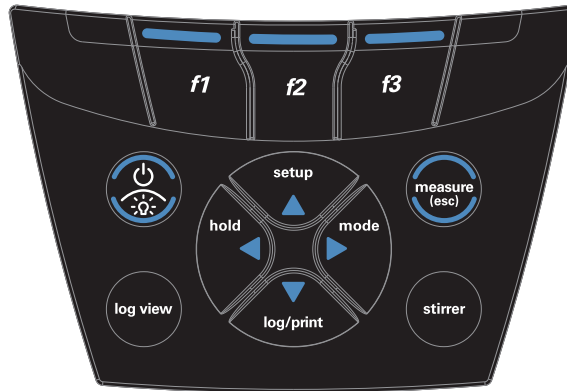

Press the **f1**, **f2** and **f3** function keys to perform the action shown above each key on the display.



Press to turn the meter on.

When the meter is on, press and quickly release to turn the display backlight on or off or hold down to turn the meter off.



In the measurement mode, press to take a measurement.

In the setup, calibration and other menus, press to escape the current menu and return to the measurement mode.



In the measurement mode, press to enter the setup menu.

In the setup, calibration and other menus, press to scroll up through a list of options.



In the continuous measurement mode, press to hold (freeze) the displayed measurement and press again to release (unfreeze) the measurement.

In the setup, calibration and other menus, press to scroll left through a list of options.



In the single channel measurement modes, press to change the displayed measurement mode. Options for channel 1 are pH, mV, RmV (relative mV) or ORP. Options for channel 2 are %sat (dissolved oxygen in percent saturation), mg/L (dissolved oxygen in milligrams per liter) or °C (probe membrane temperature).  
In the setup, calibration and other menus, press to scroll right through a list of options.



In the measurement mode, press to log or print a measurement.













In the setup, calibration and other menus, press to scroll down through a list of options.



Press to view the data log and calibration log. *Orion Star A216 benchtop meters only.*



Press to start or stop the stirrer probe. *Orion Star A216 benchtop meters only.*















1. Press  to power the meter on. When the meter is on, press and quickly release  to turn the backlight on or off or press and hold  for about three seconds to power the meter off.
2. Press  to exit any meter function and return to the measurement mode.
3. The **f1**, **f2**, and **f3** function keys perform a variety of meter operations. The menu-specific operation is shown above each key on the display. For example, press **f1** in the measurement mode to start a calibration.
4. The , ,  or  keys are used as navigation keys (up, right, down, left) when selecting from a fixed list or grid of meter options. In the measurement mode, these keys are used to access the setup menu, change the measurement mode, manually log or print a measurement and hold (freeze) a displayed measurement in the continuous measurement mode.
5. In the continuous measurement mode, when  is pressed and the measurement is being held (frozen), only the  key will be functional until the measurement is released (unfrozen).
6. Press  to turn on or off the stirrer probe (Cat. No. 096019). *Orion Star A216 benchtop meters only.*
7. Press  to access the calibration log and data log. *Orion Star A216 benchtop meters only.*

## Meter Maintenance

For routine meter maintenance, dust and wipe the meter with a damp cloth. If necessary, warm water or a mild water-based detergent can be used. Meter maintenance can be performed on a daily, weekly or monthly basis, as required by the environment in which the meter is operated. Immediately remove any spilled substance from the meter using the proper cleaning procedure for the type of spill.

## Chapter 3 Meter Setup

### Navigating the Setup Menu



1. In the measurement mode, press  to enter the main setup menu.
2. Press , ,  or  to scroll through the main setup menu options. Press **f3 (select)** to select a main setup menu option.
3. Press  or  to scroll through setup submenu options. Press **f3 (select)** to select a setup submenu option.
4. Perform the appropriate actions to set the desired parameter in the setup submenus.
  - a. To select a value from a list of options, press  or  to highlight the desired value and press **f3 (select)** to set the value.
  - b. To enter a numeric value, use the numeric entry screen.
    - i. Select the value to be entered by pressing **f3 (select)** or **f3 (edit)**. The numeric entry screen will popup on the display.
    - ii. Press , ,  or  to highlight a number, decimal place or negative sign; press **f3 (enter)** to select the highlighted item and repeat until the desired value is shown on the top of the numeric entry screen.
    - iii. Press **f2 (done)** to save the value and exit the numeric entry screen.
5. Press **f1 (back)** and then  to return to the measurement mode at any time.

### Setup Menu Overview

pH Channel	DO/RDO Channel	Settings	Log View	Diagnostics
<b>Method</b> <hr/> <b>Mode &amp; Settings</b> <ul style="list-style-type: none"> <li>• Measure Mode</li> <li>• Read Type</li> <li>• Resolution</li> <li>• Buffer Group</li> <li>• Stability</li> <li>• Averaging</li> <li>• Limit Alarm</li> <li>• Cal Due Alarm</li> </ul> <hr/> <b>Temperature</b> <ul style="list-style-type: none"> <li>• Manual Temp Value</li> <li>• Temperature Unit</li> <li>• Temperature Calibration</li> <li>• Temperature Input</li> </ul>	<b>Method</b> <hr/> <b>Mode &amp; Settings</b> <ul style="list-style-type: none"> <li>• Measure Mode</li> <li>• Measure Unit</li> <li>• Resolution</li> <li>• Read Type</li> <li>• Baro Press</li> <li>• Salinity Correct</li> <li>• Stability</li> <li>• Averaging</li> <li>• Limit Alarm</li> <li>• Cal Due Alarm</li> <li>• RDO Cap Life (<i>RDO only</i>)</li> </ul> <hr/> <b>Temperature</b> <ul style="list-style-type: none"> <li>• Manual Temp Value</li> <li>• Temperature Unit</li> <li>• Temperature Calibration</li> <li>• Temperature Input</li> </ul>	<ul style="list-style-type: none"> <li>• Export Data</li> <li>• Data Log</li> <li>• Date / Time</li> <li>• Language</li> <li>• Key Press Beep</li> <li>• Alarm Beep</li> <li>• Stirrer (<i>Star A216 meters only</i>)</li> <li>• Contrast</li> <li>• Auto Shut Off</li> <li>• User ID</li> <li>• Sample ID</li> </ul>	<ul style="list-style-type: none"> <li>• Data Log</li> <li>• Calibration Log</li> </ul>	<ul style="list-style-type: none"> <li>• Factory Reset</li> <li>• User Reset</li> <li>• Self Test</li> <li>• Stability Test</li> <li>• About Meter</li> </ul>

## pH Channel Menu

The pH Channel setup menu is used to review and change parameters relating to pH, mV, relative mV and ORP measurements and calibrations.

Main Setup Menu	2nd Level	3rd Level	Menu Options	Menu Description
pH Channel	Method	List of Methods		Menu allows the current meter settings to be saved as a new method, an existing method to be run on the meter, or an existing method to be viewed, edited, copied, deleted or printed.
	Mode and Settings	Measure Mode	<ul style="list-style-type: none"> <li>• pH</li> <li>• mV</li> <li>• RmV</li> <li>• ORP</li> </ul>	Menu used to select the displayed measurement mode, which determines the type of calibration the meter will perform.
		Read Type	<ul style="list-style-type: none"> <li>• Auto</li> <li>• Continuous</li> <li>• Timed</li> </ul>	<p>Menu used to select how the meter will take measurements.</p> <p><b>Auto (AR)</b> – Press  to take a measurement. When the measurement is stable, it is locked on the display until  is pressed again.</p> <p><b>Continuous</b> – The measurement is constantly updated on the display and <b>stabilizing</b> or <b>ready</b> is shown to indicate the measurement stability.</p> <p><b>Timed</b> – Measurements are taken at a set time interval. To enter the time interval, highlight <b>Timed</b> press  to highlight the hours (HH), minutes (MM) or seconds (SS), press <b>f3 (edit)</b> and use the numeric entry screen to change the values.</p>
		Resolution	<ul style="list-style-type: none"> <li>• 1 Decimal Place 0.1</li> <li>• 2 Decimal Places 0.01</li> <li>• 3 Decimal Places 0.001</li> </ul>	Menu used to select the resolution for the displayed measurement values.
		Buffer Group	<ul style="list-style-type: none"> <li>• USA</li> <li>• DIN</li> </ul>	Menu used to select the buffer group used for automatic buffer recognition during pH calibrations. USA – pH 1.68, 4.01, 7.00, 10.01, 12.46 buffers DIN – pH 1.68, 4.01, 6.86, 9.18 buffers





pH Channel Menu (cont.)

Main Setup Menu	2nd Level	3rd Level	Menu Options	Menu Description
pH Channel (cont.)	Mode and Settings (cont.)	Stability	<ul style="list-style-type: none"> <li>• Smart Stability</li> <li>• Fast</li> <li>• Medium</li> <li>• Slow</li> </ul>	Menu used to select how the stability of the displayed measurement values is indicated. Smart Stability automatically compensates for measurement conditions and optimizes the meter response time.
		Averaging	<ul style="list-style-type: none"> <li>• Off</li> <li>• Automatic Smart</li> </ul>	Menu used to turn the averaging function on or off. Automatic Smart automatically compensates for measurement conditions and optimizes the meter response time.
		Limit Alarm	<ul style="list-style-type: none"> <li>• Limit Alarm On Off</li> <li>• Alarm Settings Low High High/Low</li> <li>• High Limit</li> <li>• Low Limit</li> </ul>	Menu used to turn the limit alarm on or off and to set the limit alarm parameters. The limit alarm is triggered if the measurement goes above a high value and/or below a low value set by the operator. Press  or  to change the setting on each line, press  or  to select another line and use the numeric entry screen to enter limit values.
		Cal Due Alarm	<ul style="list-style-type: none"> <li>• Cal Due Alarm On Off</li> <li>• Cal Due Limit</li> </ul>	Menu used to turn the calibration due alarm on or off and to set the calibration due alarm time. The calibration due alarm is triggered if a set amount of time has passed without a calibration being performed. Press  or  to change the setting on the top line, press  or  to select another line and use the numeric entry screen to enter the calibration due value in hours.
	Temperature	Manual Temp Value	Default value or last entered value	Menu used to set the temperature value that will be used for all measurements and calibrations. Use the numeric entry screen to enter the temperature.
		Temperature Unit	<ul style="list-style-type: none"> <li>• Celsius</li> <li>• Fahrenheit</li> </ul>	Menu used to select the temperature units.
		Temperature Calibration	<ul style="list-style-type: none"> <li>• ATC</li> <li>• Solution Temperature</li> <li>• Membrane Temperature</li> <li>• Sol &amp; Mem Temperature</li> <li>• ATC, Sol &amp; Mem Temp</li> </ul>	Menu allows the temperature measured by an ATC probe (separate or built in to an electrode), solution temperature measured by a DO probe, membrane temperature measured by a DO probe or a combination of these to be adjusted by the operator.
		Temperature Input	<ul style="list-style-type: none"> <li>• ATC</li> <li>• DO Probe</li> <li>• Manual</li> </ul>	Menu used to select the source of the temperature measurement when multiple electrodes with temperature function are connected to the meter.



## DO/RDO Channel Menu

The DO/RDO Channel setup menu is used to review and change parameters relating to dissolved oxygen measurements and calibrations.

Main Setup Menu	2nd Level	3rd Level	Menu Options	Menu Description
DO/RDO Channel	Method	List of Methods		Menu allows the current meter settings to be saved as a new method, an existing method to be run on the meter, or an existing method to be viewed, edited, copied, deleted or printed.
	Mode and Settings	Measure Mode	<ul style="list-style-type: none"> <li>• DO</li> <li>• RDO</li> <li>• Auto</li> </ul>	Menu used to select the type of DO probe used. The meter accepts and automatically recognizes Orion RDO optical DO probes and Orion polarographic DO probes. Use this menu if a different probe is used or the probe type needs to be verified.
		Measure Unit	<ul style="list-style-type: none"> <li>• mg/L</li> <li>• % sat</li> </ul>	Menu used to select the displayed measurement units.
		Resolution (mg/L mode)	<ul style="list-style-type: none"> <li>• 1 Decimal Place 0.1</li> <li>• 2 Decimal Places 0.01</li> </ul>	Menu used to select the resolution for the displayed measurement values.
		Resolution (% sat mode)	<ul style="list-style-type: none"> <li>• 1 Decimal Place 1</li> <li>• 2 Decimal Places 0.1</li> </ul>	Menu used to select the resolution for the displayed measurement values.
		Read Type	<ul style="list-style-type: none"> <li>• Auto</li> <li>• Continuous</li> <li>• Timed</li> </ul>	<p>Menu used to select how the meter will take measurements.</p> <p><b>Auto (AR)</b> – Press  to take a measurement. When the measurement is stable, it is locked on the display until  is pressed again.</p> <p><b>Continuous</b> – The measurement is constantly updated on the display and <i>stabilizing</i> or <i>ready</i> is shown to indicate the measurement stability.</p> <p><b>Timed</b> – Measurements are taken at a set time interval. To enter the time interval, highlight  press  to highlight the hours (HH), minutes (MM) or seconds (SS), press <b>f3 (edit)</b> and use the numeric entry screen to change the values.</p>
		Baro Press	<ul style="list-style-type: none"> <li>• Automatic</li> <li>• Manual</li> </ul>	Menu used to select automatic or manual barometric pressure compensation for dissolved oxygen measurements. Use the numeric entry screen to enter a manual value.
		Salinity Correct	<ul style="list-style-type: none"> <li>• Manual</li> </ul>	Menu used to set manual salinity correction for dissolved oxygen measurements. Use the numeric entry screen to enter a manual value.
		Stability	<ul style="list-style-type: none"> <li>• Smart Stability</li> <li>• Fast</li> <li>• Medium</li> <li>• Slow</li> </ul>	Menu used to select how the stability of the displayed measurement values is indicated. Smart Stability automatically compensates for measurement conditions and optimizes the meter response time.

DO/RDO Channel Menu (cont.)

Main Setup Menu	2nd Level	3rd Level	Menu Options	Menu Description
<b>DO/RDO Channel (cont.)</b>	Mode and Settings (cont.)	Averaging	<ul style="list-style-type: none"> <li>• Off</li> <li>• Automatic Smart</li> </ul>	Menu used to turn the averaging function on or off. Automatic Smart automatically compensates for measurement conditions and optimizes the meter response time.
		Limit Alarm	<ul style="list-style-type: none"> <li>• Limit Alarm                             <ul style="list-style-type: none"> <li>On</li> <li>Off</li> </ul> </li> <li>• Alarm Settings                             <ul style="list-style-type: none"> <li>Low</li> <li>High</li> <li>High/Low</li> </ul> </li> <li>• High Limit</li> <li>• Low Limit</li> </ul>	Menu used to turn the limit alarm on or off and to set the limit alarm parameters. The limit alarm is triggered if the measurement goes above a high value and/or below a low value set by the operator. Press  or  to change the setting on each line, press  or  to select another line and use the numeric entry screen to enter limit values.
		Cal Due Alarm	<ul style="list-style-type: none"> <li>• Cal Due Alarm                             <ul style="list-style-type: none"> <li>On</li> <li>Off</li> </ul> </li> <li>• Cal Due Limit</li> </ul>	Menu used to turn the calibration due alarm on or off and to set the calibration due alarm time. The calibration due alarm is triggered if a set amount of time has passed without a calibration being performed. Press  or  to change the setting on the top line, press  or  to select another line and use the numeric entry screen to enter the calibration due value in hours.
		RDO Cap Life (RDO mode)	Cap Life Serial Number	Menu used to display the RDO optical cap life as days remaining and the RDO optical cap serial number.
	Temperature	Manual Temp Value	Default value or last entered value	Menu used to set the temperature value that will be used for all measurements and calibrations. Use the numeric entry screen to enter the temperature.
		Temperature Unit	<ul style="list-style-type: none"> <li>• Celsius</li> <li>• Fahrenheit</li> </ul>	Menu used to select the temperature units.
		Temperature Calibration	<ul style="list-style-type: none"> <li>• Solution Temperature</li> <li>• Membrane Temperature</li> <li>• Sol &amp; Mem Temperature</li> </ul>	Menu allows the solution temperature measured by a DO probe, membrane temperature measured by a DO probe or a combination of these to be adjusted by the operator.
		Temperature Input	<ul style="list-style-type: none"> <li>• ATC</li> <li>• DO Probe</li> <li>• Manual</li> </ul>	Menu used to select the source of the temperature measurement when multiple electrodes with temperature function are connected to the meter.

## Settings Menu

The Settings setup menu is used to review and change parameters relating to the general operation of the meter.

Main Setup Menu	2nd Level	Menu Options	Menu Description
<b>Settings</b>	Export Data	<ul style="list-style-type: none"> <li>• Printing               <ul style="list-style-type: none"> <li>• On</li> <li>• Off</li> </ul> </li> <li>• Comm Setup               <ul style="list-style-type: none"> <li>• RS232</li> <li>• USB</li> </ul> </li> <li>• Data Format               <ul style="list-style-type: none"> <li>• Printer</li> <li>• PC (CSV)</li> </ul> </li> <li>• Comm Config               <ul style="list-style-type: none"> <li>• 1200</li> <li>• 2400</li> <li>• 4800</li> <li>• 9600</li> <li>• 19200</li> <li>• 38400</li> </ul> </li> </ul>	Menu used to turn data exporting on or off, set the meter to be interfaced using the RS232 or USB port, set the exported data format for a printer (string of text) or PC (comma delimited text) and set the baud rate.
	Data Log	<ul style="list-style-type: none"> <li>• Off</li> <li>• On</li> </ul>	Menu used to turn on or off the data log feature.
	Date / Time	<ul style="list-style-type: none"> <li>• Date               <ul style="list-style-type: none"> <li>• DD/MM/YY</li> <li>• MM/DD/YY</li> </ul> </li> <li>• Time               <ul style="list-style-type: none"> <li>• 12 Hour Clock</li> <li>• 24 Hour Clock</li> </ul> </li> </ul>	Menu used to set the date format as day/month/year or month/day/year; enter the date values; set the time format as 12 hour or 24 hour clock; and enter the time values. Use the numeric entry screen to enter the values.
	Language	<ul style="list-style-type: none"> <li>• English</li> <li>• Spanish</li> <li>• German</li> <li>• French</li> <li>• Italian</li> <li>• Chinese</li> </ul>	Menu used to set the language for all displayed meter prompts.
	Key Press Beep	<ul style="list-style-type: none"> <li>• Off</li> <li>• On</li> </ul>	Menu used to turn on or off the beep sound made every time a meter key is pressed.
	Alarm Beep	<ul style="list-style-type: none"> <li>• Off</li> <li>• On</li> </ul>	Menu used to turn on or off the beep sound made when an alarm value is reached.

### Settings Menu (cont.)

Main Setup Menu	2nd Level	Menu Options	Menu Description
<b>Settings (cont.)</b>	Stirrer	<ul style="list-style-type: none"> <li>• Speed 1</li> <li>• Speed 2</li> <li>• Speed 3</li> <li>• Speed 4</li> <li>• Speed 5</li> </ul>	Menu used to turn the stirrer probe on or off and to set the stirrer probe speed. <i>Star A216 meters only.</i>
	Contrast	<ul style="list-style-type: none"> <li>• Level 1</li> <li>• Level 2</li> <li>• Level 3</li> <li>• Level 4</li> <li>• Level 5</li> <li>• Level 6</li> </ul>	Menu used to set the display contrast.
	Auto Shut Off	<ul style="list-style-type: none"> <li>• Off</li> <li>• On</li> </ul>	Menu used to turn on or off the meter automatic shutoff feature, which turns the meter off when no keys are pressed for 20 minutes.
	User ID	Default value or last entered value	Menu used to set the user ID. Use the alphanumeric entry screen to enter the user ID.
	Sample ID	<ul style="list-style-type: none"> <li>• Off</li> <li>• Manual</li> <li>• Auto Incremental</li> </ul>	Menu used to turn the sample ID off or on. When sample ID is set to manual or auto incremental, enter the sample ID in the measurement mode by pressing <b>f2 (sample ID)</b> and using the alphanumeric entry screen.

### View Log Menu

The View Log setup menu is used to access information stored in the data log and calibration log. Refer to the Data Storage and Retrieval chapter for detailed information on using this setup menu.

### Diagnostics Menu

The Diagnostics setup menu is used to perform the meter self-test, reset the meter to the factory default settings and display meter information including serial number and software revision. Refer to the Customer Services chapter for detailed information on using this setup menu.

*This page intentionally left blank.*







## Chapter 4 pH, RmV and ORP Calibration

The Orion Star A200 and Star A300 series pH meters can perform a one to five point pH calibration, one point relative mV calibration and one point ORP calibration. Step-by-step instructions and prompts are displayed on the meter to assist operators with the calibration menus. The meter can save up to 10 calibrations in the log and calibration data can be exported from the meter to a printer or computer.





### pH Calibration

One to five pH buffers can be used for calibration. Always use fresh pH buffers and select buffers that bracket the sample pH and are one to four pH units apart. Prepare the pH electrode according to the instructions in the electrode use guide. Connect the pH electrode and any other electrodes to be used (stirrer probe, ATC probe, reference electrode) to the meter. Power on the meter and set the measurement mode to pH.

*Note: In most calibration screens, press **f1 (esc)** to return to the measurement mode without saving the calibration.*

1. In the measurement mode, press **f1 (cal)**. In dual channel measurement displays, press  or  to highlight **pH – Channel** and press **f2 (select)**.
2. Rinse the pH electrode and any other electrodes in use with distilled water, blot dry with a lint-free tissue and place into the pH buffer.
3. When the electrode and buffer are ready, press **f3 (start)**. If using a Star A216 benchtop meter and stirrer probe, the stirrer probe will automatically start stirring at the speed selected in the setup menu once **f3 (start)** is pressed and stop stirring once the reading stabilizes.
4. Wait for the pH value on the meter to stabilize and stop flashing and perform one of the following actions:
  - a. Press **f2 (accept)** to accept the displayed value.
  - b. Press **f3 (edit)** to access the numeric entry screen and edit the value.
    - i. Press , ,  or  to highlight a number, decimal point or negative sign; press **f3 (enter)** to select the highlighted item and repeat until the value at the measured temperature is shown above the numeric entry screen.
    - ii. Press **f2 (done)** to exit the numeric entry screen.
    - iii. Press **f2 (accept)** to accept the entered value.
5. Press **f2 (next)** to proceed to the next buffer and repeat steps 2 through 4 or press **f3 (cal done)** to save and end the calibration. If five buffers are used, the calibration will save and end once the fifth value is accepted.
  - a. If a one point calibration is performed, press **f2 (accept)** to accept the displayed slope value or press **f3 (edit)** to access the numeric entry screen, enter the slope value and press **f2 (accept)**.
6. The meter will display the calibration summary including the average slope and export the data to the calibration log. Press **f1 (meas)** to proceed to the measurement mode or press **f2 (print)** to proceed to the measurement mode and export the data to a printer or computer.







## Calibration Editing

1. In the calibration summary display (pH calibration step 6), press **f3 (cal edit)** to edit the calibration points.
2. Press  or  to highlight the calibration point to be edited and press **f2 (select)**.
3. Press  or  to highlight *Remeasure*, *Edit* or *Delete* and press **f2 (select)**.
  - a. If *Remeasure* is selected, repeat pH calibration steps 2 through 4.
  - b. If *Edit* is selected, press **f3 (edit)** to access the numeric entry screen, enter the new value, press **f2 (done)** and then press **f2 (accept)**. Select another calibration point to edit or press **f1 (back)**.
  - c. If *Delete* is selected, the calibration point will be deleted. If deleting the calibration point changes the calibration to a one point calibration, enter the slope using the numeric entry screen.
4. The meter will display an updated calibration summary and export the data to the calibration log. Press **f1 (meas)** to proceed to the measurement mode, press **f2 (print)** to proceed to the measurement mode and export the data to a printer or computer or press **f3 (cal edit)** to edit another calibration point.

## RmV Calibration

One standard can be used for a relative mV calibration. Always use fresh standard. Prepare the electrode according to the instructions in the electrode use guide. Connect the electrode and any other electrodes to be used (stirrer probe, ATC probe, reference electrode) to the meter. Power on the meter and set the measurement mode to RmV.

*Note: In most calibration screens, press **f1 (esc)** to return to the measurement mode without saving the calibration.*

1. In the measurement mode, press **f1 (cal)**. In dual channel measurement displays, press  or  to highlight *pH – Channel* and press **f2 (select)**.
2. Rinse the electrode and any other electrodes in use with distilled water, blot dry with a lint-free tissue and place into the standard.
3. When the electrode and standard are ready, press **f3 (start)**. If using a Star A216 benchtop meter and stirrer probe, the stirrer probe will automatically start stirring at the speed selected in the setup menu once **f3 (start)** is pressed and stop stirring once the reading stabilizes.
4. Wait for the mV value on the meter to stabilize, indicated by the flashing **stabilizing** or solid **ready** icon, and perform one of the following actions:
  - a. Press **f2 (accept)** to accept the mV value shown on the *Rel Value* line.
  - b. Press **f3 (edit)** to access the numeric entry screen and edit the mV value shown on the *Rel Value* line.
    - i. Press , ,  or  to highlight a number, decimal point or negative sign; press **f3 (enter)** to select the highlighted item and repeat until the value at the measured temperature is shown.
    - ii. Press **f2 (done)** to exit the numeric entry screen.
    - iii. Press **f2 (accept)** to accept the entered mV value.
5. The meter will display the calibration summary including the mV offset and export the data to the calibration log. Press **f1 (meas)** to proceed to the measurement mode or press **f2 (print)** to proceed to the measurement mode and export the data to a printer or computer.



## ORP Calibration

The mV reading of an ORP standard is dependent on the ORP electrode reference system, reference material and filling solution as well as the ORP standard temperature. An ORP electrode can be automatically calibrated to read 420 mV relative to the Standard Hydrogen Electrode ( $E_H$ ) at 25°C when the Orion ORP standard (Cat. No. 967901 or 967961), Orion ORP electrode (Cat. No. 9678BNWP, 9778BNWP, 9180BNMD or 9179BNMD) and Orion 4 M KCl filling solution (Cat. No. 900011) or 4 M KCl gel (in Cat. No. 9179BNMD) are used. The raw mV reading of an electrode with the same conditions is 220 mV at 25 °C.

The Thermo Scientific Orion ORP standard is nonhazardous, stable and will not change over time, so it is an ideal standard for any ORP measurement system. The Orion Star A200 and Star A300 series pH meters offer a simple, automatic calibration to the  $E_H$  value in the ORP mode when using Orion ORP electrodes and standard. Visit [www.thermoscientific.com/water](http://www.thermoscientific.com/water) for ORP application notes that include a table of ORP standard values at different temperatures.

One standard can be used for ORP calibration. Always use fresh ORP standard. Prepare the ORP electrode according to the instructions in the electrode use guide. Connect the electrode and any other electrodes to be used (stirrer probe, ATC probe, reference electrode) to the meter. Power on the meter and set the measurement mode to ORP.

*Note: In most calibration screens, press **f1 (esc)** to return to the measurement mode without saving the calibration.*

1. In the measurement mode, press **f1 (cal)**. In dual channel measurement displays, press  or  to highlight **pH – Channel** and press **f2 (select)**.
2. Rinse the ORP electrode and any other electrodes in use with distilled water, blot dry with a lint-free tissue and place into the standard.
3. When the electrode and standard are ready, press **f3 (start)**. If using a Star A216 benchtop meter and stirrer probe, the stirrer probe will automatically start stirring at the speed selected in the setup menu once **f3 (start)** is pressed and stop stirring once the reading stabilizes.
4. Wait for the mV value on the meter to stabilize, indicated by the flashing **stabilizing** or solid **ready** icon, and press **f2 (accept)** once the value is stable.
5. The meter will display the calibration summary including the mV offset and export the data to the calibration log. Press **f1 (meas)** to proceed to the measurement mode or press **f2 (print)** to proceed to the measurement mode and export the data to a printer or computer.



*This page intentionally left blank.*

## Chapter 5 RDO/DO Calibration





Polarographic DO probes only - A polarographic DO probe must be polarized. The probe is continuously polarized when it is connected to the meter. If the probe is not connected to the meter: connect the probe to the meter, connect the meter to a power source and wait 30 to 60 minutes for polarization.

The Orion Star A200 and Star A300 meters can perform a calibration using water-saturated air (Air), air-saturated water (Water), Winkler titration (Manual) or zero point calibration (Set Zero). Step-by-step instructions and prompts are displayed on the meter to assist operators with the calibration menus. The meter can save up to 10 calibrations in the log and calibration data can be exported from the meter to a printer or computer.

### Air Dissolved Oxygen Calibration

An air calibration is performed in water-saturated air using the calibration sleeve included with the DO probe. This is the simplest and most accurate calibration. Due to the inherent differences between water-saturated air and air-saturated water, 102.3% saturation will be displayed when the calibration reading is stable when using a polarographic DO probe. The highest possible accuracy is reached when calibration temperature is the same as the measuring temperature. Moisten the sponge or absorbent cloth in the calibration sleeve with distilled water and insert the probe into the sleeve without touching the water saturated material. For BOD measurements, this calibration can be performed in a BOD bottle.





*Note: In most calibration screens, press **f1 (esc)** to return to the measurement mode without saving the calibration.*

1. In the measurement mode, press **f1 (cal)**. In dual channel measurement displays, press  or  to highlight **DO/RDO – Channel** and press **f2 (select)**.
2. Press  or  to highlight **Air** and press **f3 (select)**.
3. Rinse the RDO optical DO probe or polarographic DO probe with distilled water, blot dry with a lint-free tissue and place into the prepared calibration sleeve or BOD bottle. Allow the probe and water-saturated air to reach equilibrium.
4. When the probe and water-saturated air are ready, press **f3 (start)**.
5. Wait for the dissolved oxygen reading on the meter to stabilize and stop flashing. Once the reading is stable, the meter will display *Reading is stable. Accept Auto Calibration Value* and **101.7 %** if using an RDO optical DO probe or **102.3 %** if using a polarographic DO probe.
6. Press **f3 (cal done)** to export the data to the calibration log or press **f2 (print)** to export the data to the calibration log and a printer or computer. The meter will proceed to the measurement mode.

## Water Dissolved Oxygen Calibration

A water calibration is performed using water that is 100% saturated with air. Bubble air into a water sample and gently stir the sample to prevent the buildup of air bubbles on the dissolved oxygen probe membrane.









*Note: In most calibration screens, press **f1 (esc)** to return to the measurement mode without saving the calibration.*

1. In the measurement mode, press **f1 (cal)**. In dual channel measurement displays, press  or  to highlight *DO/RDO – Channel* and press **f2 (select)**.
2. Press  or  to highlight *Water* and press **f3 (select)**.
3. Rinse the DO probe and any other electrodes in use with distilled water, blot dry with a lint-free tissue and place into the prepared air-saturated water. Allow the DO probe and air-saturated water to reach equilibrium.
4. When the DO probe and air-saturated water are ready, press **f3 (start)**.
5. Wait for the dissolved oxygen reading on the meter to stabilize and stop flashing. Once the reading is stable, the meter will display *Reading is stable. Accept Auto Calibration Value* and **100 %**.
6. Press **f3 (cal done)** to export the data to the calibration log or press **f2 (print)** to export the data to the calibration log and a printer or computer. The meter will automatically proceed to the measurement mode.

## Manual Dissolved Oxygen Calibration

A manual calibration is performed using a water sample with a known concentration of dissolved oxygen. This method can be used to calibrate the DO probe to the value achieved by a Winkler titration. A manual calibration involves performing a Winkler titration and using that sample as a calibration standard. The oxygen level result from the titration is entered in a manual calibration as the dissolved oxygen value. This correlates the meter input to the Winkler titration. This method is inherently less accurate, due to the possibility of titration errors.





*Note: In most calibration screens, press **f1 (esc)** to return to the measurement mode without saving the calibration.*

1. In the measurement mode, press **f1 (cal)**. In dual channel measurement displays, press  or  to highlight **DO/RDO – Channel** and press **f2 (select)**.
2. Press  or  to highlight **Manual** and press **f3 (select)**.
3. Rinse the DO probe and any other electrodes in use with distilled water, blot dry with a lint-free tissue and place into the prepared water sample with a known dissolved oxygen concentration. Allow the DO probe and water sample to reach equilibrium.
4. When the DO probe and water sample are ready, press **f3 (start)**.
5. Wait for the dissolved oxygen reading on the meter to stabilize and stop flashing. Perform one of the following actions:
  - a. Press **f2 (accept)** to accept the displayed dissolved oxygen value in mg/L (milligrams per liter).
  - b. Press **f3 (edit)** to access the numeric entry screen and edit the dissolved oxygen value.
    - i. Press , ,  or  to highlight a number or decimal point, press **f3 (enter)** to select the highlighted item and repeat until the dissolved oxygen value in mg/L is shown.
    - ii. Press **f2 (done)** to exit the numeric entry screen.
    - iii. Press **f2 (accept)** to accept the entered dissolved oxygen value.
6. Press **f3 (cal done)** to export the data to the calibration log or press **f2 (print)** to export the data to the calibration log and a printer or computer. The meter will automatically proceed to the measurement mode.

## Set Zero Dissolved Oxygen Calibration

A zero point calibration is performed in an oxygen-free solution. Zero the probe when using a new membrane, using fresh electrolyte solution or when measuring dissolved oxygen levels below 10% saturation or 1 mg/L. A zero point calibration is not generally required unless measurements will be taken below 10% saturation or 1 mg/L. Perform an air or water calibration before performing a zero point calibration.















*Note: In most calibration screens, press **f1 (esc)** to return to the measurement mode without saving the calibration.*

1. In the measurement mode, press **f1 (cal)**. In dual channel measurement displays, press  or  to highlight **DO/RDO – Channel** and press **f2 (select)**.
2. Press  or  to highlight **Set Zero** and press **f3 (select)**.
3. Rinse the RDO optical DO probe or polarographic DO probe and any other electrodes in use with distilled water, blot dry with a lint-free tissue and place into the prepared zero oxygen standard. Allow the probe and standard to reach equilibrium.
4. When the probe and zero oxygen standard are ready, press **f3 (start)**.
5. Wait for the dissolved oxygen reading on the meter to stabilize and stop flashing. Once the reading is stable, the meter will display **Reading is stable. Accept Auto Calibration Value** and **0.00**.
6. Press **f3 (cal done)** to export the data to the calibration log or press **f2 (print)** to export the data to the calibration log and a printer or computer. The meter will proceed to the measurement mode.

## Chapter 6 Temperature Calibration

The meter ATC temperature display has a relative accuracy of  $\pm 0.1$  °C. ATC probes (both separate and those built into electrodes) have varying temperature accuracies, usually  $\pm 0.5$  °C to  $\pm 2$  °C. Use this function only if it is necessary to calibrate the temperature readings taken by the ATC probe. Since the temperature offset calculated during the calibration is applied to all future temperature measurements, recalibrate if a different ATC probe is used.

Temperature calibration is for the calibration of an ATC probe (separate or built in to a pH electrode or ORP electrode), the solution temperature measured by a DO probe, the membrane temperature measured by a DO probe or a combination of these. If manual temperature compensation is being used and the display shows MAN as the temperature source icon, set the manual temperature value using the Manual Temp Value menu. The temperature calibration menu is not accessible unless an ATC probe is connected to the meter.

1. In the measurement mode, press .
2. Press , ,  or  to highlight *pH Channel* or *DO/RDO Channel* and press **f3 (select)**.
3. Press  or  to highlight *Temperature* and press **f3 (select)**.
4. Press  or  to highlight *Temperature Calibration* and press **f3 (select)**.
5. Press  or  to highlight *ATC*, *Solution Temperature*, *Membrane Temperature*, *Sol & Mem Temperature* or *ATC*, *Sol & Mem Temp* to identify the ATC probe and/or DO probe that will be calibrated and press **f3 (select)**.
6. Place the ATC probe and/or DO probe and thermometers into a solution with a known, stable temperature. It is recommended that two NIST traceable thermometers be used to measure and verify the temperature of the solution.
7. Wait for the temperature readings of the ATC probe and/or DO probe and thermometers to stabilize (usually two to five minutes).
8. Press **f3 (edit)** to access the numeric entry screen and edit the temperature value.
  - a. Press , ,  or  to highlight a number, decimal point or negative sign; press **f3 (enter)** to select the highlighted item and repeat until the temperature value read by the thermometers is shown on the display.
  - b. Press **f2 (done)** to exit the numeric entry screen.
9. The meter will display the entered temperature value on the *Reference Temp* line, the original temperature read by the ATC probe and/or DO probe on the *ATC* line and the temperature offset value that will be applied to all future temperature readings on the *Offset* line. Press **f2 (accept)** to proceed with the displayed temperature data, save and end the calibration and export the data to the calibration log.
10. Press **f1 (meas)** to proceed to the measurement mode or press **f2 (print)** to proceed to the measurement mode and export the data to a printer or computer.



*This page intentionally left blank.*





## Chapter 7 Measurement

The Orion Star A216 and Star A326 meters are capable of showing two measurements simultaneously on the display. The first channel can be set to measure pH, mV, RmV (relative mV) or ORP. The second channel can be set to measure DO - %sat (dissolved oxygen in percent saturation), DO - mg/L (dissolved oxygen in milligrams per liter) or DO - °C (probe membrane temperature).

The meter can be set to display one or both of these measurement channels, depending on the operator's needs. In the measurement mode, press **f3 (channel)** to scroll through a single measurement display of channel one or channel two or a dual measurement display of channel one and two. To change the measurement mode of a channel, press **f3 (channel)** until the single measurement display of that channel is shown and then press  until the correct mode is shown.

*Note: It is highly recommended that any unused channels not be shown on the meter display while taking measurements, since the meter waits for all displayed channels to stabilize before logging the measurement data.*

Press  while taking a measurement in the continuous measurement mode to freeze the display and press  a second time to unfreeze the display and continue the measurement. Press  while taking a measurement to manually export the measurement to the data log, if the data log is enabled in the setup menu.

1. Rinse the pH electrode cell, RDO optical dissolved oxygen probe or polarographic dissolved oxygen probe and any other electrodes in use with distilled water, blot dry with a lint-free tissue and place into the sample.
2. *Star A216 meters only* – If the stirrer probe is in use and the meter is in continuous or timed mode, press  to turn on the stirrer probe. If the stirrer probe is in use and the meter is in AUTO-READ mode, the stirrer probe will start stirring when  is pressed and stop stirring when the reading stabilizes.
3. Start the measurement and wait for it to stabilize.
  - a. If the meter is in AUTO-READ mode (default setting), press  to start the measurement. When the **AR** icon stops flashing, record the applicable measurement parameters and temperature of the sample. Press  again to start a new measurement.
  - b. If the meter is in continuous mode, the meter will immediately start taking a measurement and update the display whenever the measurement changes. Wait for the display to show **ready** and record the applicable measurement parameters and temperature of the sample.
  - c. If the meter is in timed mode, the meter will log measurements at the preselected time interval, regardless of the measurement stability. The meter will update the display whenever the measurement changes, so the applicable measurement parameters and temperature of the sample can be recorded when the display shows **ready**.
4. *Star A216 meters only* – If the stirrer probe is in use and the meter is in continuous or timed mode, press  to turn off the stirrer probe.
5. Remove the electrodes from the sample, rinse with distilled water, blot dry and place into the next sample.
6. Repeat steps 2 through 5 for all samples.
7. When all samples have been measured, store the electrodes according to their user guides.

















*This page intentionally left blank.*









## Chapter 8 Methods

The Orion Star A200 and Star A300 series meters can save up to ten methods per channel and the corresponding calibration data for each method, for the fast and easy recollection of different meter setup parameters. The default meter setting is that no method is used and the method number will be shown as M100 or M300 if no method is in use. The current meter settings can be saved in the setup menu. Existing methods can be selected from the methods list and run on the meter. Methods can be viewed, edited, copied to a new method or deleted.





















### Saving the Current Meter Settings as a New Method

1. In the measurement mode, press .
2. Press , ,  or  to highlight *pH Channel* or *DO/RDO Channel* and press **f3 (select)**.
3. Press  or  to highlight *Method* and press **f3 (select)**.
4. The meter will display *Current Settings* and a list of methods. The list will show the sequential number of the methods (*M101*) and the date, time and mode of each method (*07/01/11 12:45 pH*) if methods have been previously created.
5. Press  or  to highlight *Current Settings* and press **f3 (save)**.
6. Press  or  to highlight a method number that the current settings will be saved as and press **f2 (accept)**.
7. The meter will prompt for a method specific password to be created. The password must be at least 3 characters long.
  - a. Press **f3 (edit)** to access the numeric entry screen.
  - b. Press , ,  or  to highlight a number, press **f3 (enter)** to select the highlighted number and repeat until the new password is shown.
  - c. Press **f2 (done)** to exit the numeric entry screen.
  - d. Press **f2 (accept)** to accept the entered password.
8. The meter will automatically proceed to the measurement mode.

### Loading an Existing Method

1. In the measurement mode, press .
2. Press , ,  or  to highlight *pH Channel* or *DO/RDO Channel* and press **f3 (select)**.
3. Press  or  to highlight *Method* and press **f3 (select)**.
4. The meter will display *Current Settings* and a list of methods. The list will show the sequential number of the methods (*M101*) and the date, time and mode of each method (*07/01/11 12:45 pH*) if methods have been previously created.
5. Press  or  to highlight the method to be loaded and press **f2 (load)**.
6. The meter will automatically proceed to the measurement mode.

## Editing, Copying or Deleting an Existing Method

1. In the measurement mode, press .
2. Press , ,  or  to highlight *pH Channel* or *DO/RDO Channel* and press **f3 (select)**.
3. Press  or  to highlight *Method* and press **f3 (select)**.
4. The meter will display *Current Settings* and a list of methods. The list will show the sequential number of the methods (*M101*) and the date, time and mode of each method (*07/01/11 12:45 pH*) if methods have been previously created.
5. Press  or  to highlight the desired method and press **f3 (options)**.
6. Enter the method specific password.
  - a. Press **f3 (edit)** to access the numeric entry screen.
  - b. Press , ,  or  to highlight a number, press **f3 (enter)** to select the highlighted number and repeat until the password is shown.
  - c. Press **f2 (done)** to exit the numeric entry screen.
  - d. Press **f2 (accept)** to accept the entered password.
7. Press  or  to highlight *Edit*, *Copy* or *Delete* and press **f2 (accept)**.
  - a. If *Edit* is selected – press  or  to highlight any setup menu parameters that need to be changed and press **f3 (select)**. Review and change all applicable setup menu parameters. Press **f1 (back)** to return to the list of methods and then press  to return to the measurement mode.
  - b. If *Copy* is selected – press  or  to highlight a method number that the selected method will be copied to and press **f2 (accept)**. The meter will automatically proceed to the measurement mode.
  - c. If *Delete* is selected – press **f2 (yes)** to delete the method or press **f3 (no)** to keep the method. The meter will automatically proceed to the measurement mode.













---

## Chapter 9 Data Storage and Retrieval

























### Data Storage Settings

The data and calibration storage settings include the measurement read type, computer and printer export settings and data log settings. The measurement read type determines when the meter sends measurements to the data log, if the data log is enabled in the setup menu, and to a printer or computer, if a printer or computer is connected to the meter and enabled in the setup menu. Review the date and time settings and update as needed.











#### Read Type Selection

1. In the measurement mode, press .
2. Press , ,  or  to highlight *pH Channel* or *DO/RDO Channel* and press **f3 (select)**.
3. Press  or  to highlight *Mode and Settings* and press **f3 (select)**.
4. Press  or  to highlight *Read Type* and press **f3 (select)**.
5. Press  or  to highlight *Auto*, *Continuous* or *Timed* and press **f3 (select)**.
  - a. If *Timed* is selected and the time interval needs to be changed – highlight *Timed*; press  to highlight hours (HH), minutes (MM) or seconds (SS); press **f3 (edit)** to access the numeric entry screen; use the numeric entry screen to change the values and press **f1 (back)** when the time interval is correct.
6. Press  to return to the measurement mode.

## Computer and Printer Export Settings

1. In the measurement mode, press .
2. Press , ,  or  to highlight **Settings** and press **f3 (select)**.
3. Press  or  to highlight **Export Data** and press **f3 (select)**.
4. Press  or  to highlight **Printing** and press **f3 (select)**. Press  or  to highlight **On** or **Off** and press **f3 (select)**. Select **On** to allow data to be sent to a computer or printer.
5. Press  or  to highlight **Comm Setup** and press **f3 (select)**. Press  or  to highlight **RS232** or **USB** and press **f3 (select)**. Select **RS232** if the meter will be interfaced using the RS232 port and select **USB** if the meter will be interfaced using the USB port.
6. Press  or  to highlight **Data Format** and press **f3 (select)**. Press  or  to highlight **Printer** or **PC (CSV)** and press **f3 (select)**. Select **Printer** to export the data as a string of text and select **PC (CSV)** to export the data in comma delimited format.
7. Press  or  to highlight **Comm Config** and press **f3 (select)**. Press  or  to highlight **1200, 2400, 4800, 9600, 19200 or 38400** and press **f3 (select)**. Select the baud rate best for the data transfer requirements. The fixed meter output settings are 8 bits, 1 stop bit and parity none.
8. Press **f1 (back)** and then press  to return to the measurement mode.















## Data Log Settings

1. In the measurement mode, press .
2. Press , ,  or  to highlight **Settings** and press **f3 (select)**.
3. Press  or  to highlight **Data Log** and press **f3 (select)**.
4. Press  or  to highlight **Off** or **On** and press **f3 (select)**.
5. Press **f1 (back)** and then press  to return to the measurement mode.













## Viewing the Calibration Log and Data Log

The Orion Star A200 and Star A300 series meters save up to ten of the most recent calibrations per channel. The Star A216 meter saves up to 2000 sets of data points and the Star A326 meter saves up to 5000 sets of data points. A log number is assigned to each data point. The read type of the displayed channel or channels determines when measurements are exported to the data log. When a data point is exported to a computer or printer, the time stamp will include the hour, minutes and seconds.























### Viewing the Calibration Log

1. In the measurement mode, press .
2. Press , ,  or  to highlight *View Log* and press **f3 (select)**.
3. Press  or  to highlight *Calibration Log* and press **f2 (accept)**.
4. Press  or  to highlight *pH – Channel* or *DO/RDO – Channel* and press **f2 (select)**.
5. Press  or  to highlight *pH*, *RmV* or *ORP* (pH – Channel) or *DO* or *RDO* (DO/RDO – Channel) and press **f2 (select)**.
6. The meter will display a list of calibrations for the selected channel and calibration type. The list shows the sequential number of the calibration and the date and time it was saved (*07/01/2011 12:45*).
7. To view the calibration data, press  or  to highlight a specific calibration and press **f2 (select)**. Press **f2 (print)** to print the calibration, press **f3 (info)** to view the electrode slope between pH buffer points (pH – Channel only) or press **f1 (back)** to return to the list of calibrations.
8. Press  to return to the measurement mode.











### Viewing the Data Log

1. In the measurement mode, press .
2. Press , ,  or  to highlight *View Log* and press **f3 (select)**.
3. Press  or  to highlight *Data Log* and press **f2 (accept)**.
4. Press  or  to highlight *pH – Channel* or *DO/RDO – Channel* and press **f2 (select)**.
5. The meter will display a list of the data points. The list shows the sequential number of the data point and the date and time the data point was saved (*07/01/2011 12:45*).
6. To view the measurement information for an individual data point, press  or  to highlight the data point and press **f2 (select)**. Press **f2 (print)** to print the data point or press **f1 (back)** to return to the list of data points.
7. Press  to return to the measurement mode.

## Exporting the Data Log to a Computer or Printer

1. In the measurement mode, press .
2. Press , ,  or  to highlight *View Log* and press **f3 (select)**.
3. Press  or  to highlight *Data Log* and press **f2 (accept)**.
4. Press  or  to highlight *pH – Channel* or *DO/RDO – Channel* and press **f3 (select)**.
5. The meter will display a list of the data points. The list shows the sequential number of the data point and the date and time the data point was saved (*07/01/2011 12:45*).
6. Press **f3 (options)**.
7. Press  or  to highlight *Log Export* and press **f2 (accept)**.
8. Press  or  to highlight *Today, Last 10, Range* or *All* as the data log points to be exported and press **f2 (accept)**.
  - a. If *Today, Last 10* or *All* is selected – press **f2 (yes)** to export the data.
  - b. If *Range* is selected – enter the first and last date points:
    - i. Press **f3 (edit)** to display the numeric entry screen.
    - ii. Press , ,  or  to highlight a number, press **f3 (enter)** to select the highlighted number and repeat until the number of the first data point to be exported is shown on the display.
    - iii. Press **f2 (done)** to exit the numeric entry screen.
    - iv. Press  to enter the last data point.
    - v. Press **f3 (edit)** to display the numeric entry screen.
    - vi. Press , ,  or  to highlight a number, press **f3 (enter)** to select the highlighted number and repeat until the number of the last data point to be exported is shown on the display.
    - vii. Press **f2 (done)** to exit the numeric entry screen.
    - viii. Press **f2 (accept)** and then press **f2 (yes)** to export the data.
9. After exporting the data, the meter will automatically return to the measurement mode.

## Clearing the Data Log

1. In the measurement mode, press .
2. Press , ,  or  to highlight *View Log* and press **f3 (select)**.
3. Press  or  to highlight *Data Log* and press **f2 (accept)**.
4. Press  or  to highlight *pH – Channel* or *RDO/DO – Channel* and press **f3 (select)**.
5. The meter will display a list of the data points. The list shows the sequential number of the data point and the date and time the data point was saved (*07/01/2011 12:45*).
6. Press **f3 (options)**.
7. Press  or  to highlight *Log Clear* and press **f2 (accept)**.
8. Press **f2 (yes)** twice to clear the entire data log.
9. Enter the password. The default is **11111** and pressing **f2 (accept)** will advance the meter to the next step.
10. Press **f1 (back)** and then press  to return to the measurement mode.



## Interfacing a Printer

The Orion Star printer, Cat. No. 1010006, is recommended for use with the Orion Star A200 and Star A300 series meters. The Orion Star printer has a 9600 baud rate and it is packaged with the RS232 printer cable, Cat. No. 250302-001, which is required to interface an Orion Star A meter to a printer. The baud rate of the Orion Star A200 and Star A300 series meters can be set to 1200, 2400, 4800, 9600, 19200 or 38400 for communication to different printers. The fixed meter settings are: number of bits = 8, stop bits = 1, parity = none. The flow control for the printer should be set to XON/XOFF. The meter will send measurements and calibration data to the printer if the printer option is turned on in the setup menu. Alternatively, measurements and calibration data can be sent to the data log and calibration log. From the data log and calibration log, the operator can chose to print a single data log point, a range of data log points or the entire data log.

## Interfacing a Computer

The Orion Star A200 and Star A300 series meters can send measurements and calibration data to a computer in a comma delimited format that is easy to parse in computer programs like Excel. Connect the RS232 computer cable, Cat. No. 1010053, to the RS232 input on the meter and the RS232 input on a computer. The baud rate of the Orion Star A series meters can be set to 1200, 2400, 4800, 9600, 19200 or 38400. The fixed meter settings are: number of bits = 8, stop bits = 1, parity = none. The flow control for the computer should be set to XON/XOFF. The meter will send measurements and calibration data to the computer if the computer option is turned on in the setup menu. Alternatively, measurements and calibration data can be sent to the data log and calibration log. From the data log and calibration log, the operator can chose to send a single data log point, a range of data log points or the entire data log to the computer.

*A complimentary copy of general data logging software is available for use with the Orion Star A200 and Star A300 series meters. This can be found on the CD included with the meter or at [www.thermoscientific.com/water](http://www.thermoscientific.com/water).*

---









## Chapter 10 Customer Services

### Meter Errors and Recommended Actions

Error	Recommended Actions
Display Error	If this error occurs, contact Technical Support.
Hardware Error	If this error occurs, contact Technical Support.
Channel Input Error	Disconnect all of the electrodes from the meter, connect the BNC shorting cap to the BNC inputs and repeat the self test.
Reference Input Error	Make sure that all of the electrodes are disconnected from the meter (including the reference input), connect the BNC shorting cap to the BNC input and repeat the self test.
Ground Input Error	Make sure that all of the electrodes are disconnected from the meter (including the ground input), connect the BNC shorting cap to the BNC input and repeat the self test.
Keypad Failure	Repeat the self test. When the meter prompts, press each of the keys one at a time, including the power key, within five seconds of one other. If the error persists, contact Technical Support.
Over Range Measurement or Under Range Measurement	If the measurement is flashing 9999 and over range or under range, the measurement value is outside of the allowable measurement range. Make sure that the electrode is connected to the appropriate meter input and the electrode parameters are entered correctly in the setup menu. Clean the electrode according to the electrode user guide and re-calibrate the electrode with new buffers or standards. If the error persists, perform the meter self test.
Measurement Out of Range	Make sure that the electrode is connected to the appropriate meter input and the electrode parameters are entered correctly in the setup menu. Clean the electrode according to the electrode user guide and re-calibrate the electrode with new buffers or standards. Perform the meter self test.

## Meter Self Test and Checkout











### *Meter Self Test*

1. In the measurement mode, press setup .
2. Press , ,  or  to highlight *Diagnostics* and press **f3 (select)**.
3. Press  or  to highlight *Self Test* and press **f2 (accept)**.
4. Disconnect all of the electrodes and probes from the meter, attach the BNC shorting cap to the BNC input and press **f2 (yes)**.
5. Press **f2 (yes)** to start the self test.
6. The meter will perform an accuracy test. When the meter displays *Accuracy Test Passed*, press **f2 (next)**.
7. The meter will perform an EPROM test. When the meter displays *E2Prom Test Passed*, press **f2 (next)**.
8. The meter will perform a keypad test. Press each of the keys on the keypad (including ) one at a time in any order. When the meter displays *Keypad Test Passed*, press **f2 (next)**.
9. The meter will display *Self Test Passed*. Press  to return to the measurement mode.

### *Meter Checkout (pH)*







1. After the self test is complete, the meter will return to the measurement mode. Keep all of the electrodes disconnected from the meter and keep the BNC shorting cap attached to the BNC input on the meter.
2. Set the measurement mode to pH. The meter should read a steady  $7.000 \text{ pH} \pm 0.002 \text{ pH}$ . If the meter does not read a steady  $7.000 \pm 0.002$ , perform a one point pH calibration with the BNC shorting cap attached to the BNC input. Set the pH value to 7.000 and the slope value to 100.0. Refer to the pH Calibration section for detailed instructions.
3. In the measurement mode, the meter should read a steady  $0.0 \text{ mV} \pm 0.2 \text{ mV}$ . If the meter does not read a steady  $0.0 \text{ mV} \pm 0.2 \text{ mV}$  with the BNC shorting cap attached to the BNC input, contact Technical Support.

## Electrode Stability Test

1. In the measurement mode, press .
2. Press , ,  or  to highlight *Diagnostics* and press **f3 (select)**.
3. Press  or  to highlight *Stability Test* and press **f2 (accept)**.
4. Press  or  to highlight *pH – Channel* or *DO/RDO – Channel* and press **f2 (next)**.
5. Make sure the electrode or probe to be tested is connected to the channel selected in the previous step and press **f2 (yes)**.
6. Place the electrode or probe in an appropriate solution with a stable temperature and press **f2 (yes)**.
  - a. Orion pH 7 buffer (Cat. No. 910107, 910760 or 910710) is recommended for testing a pH electrode.
  - b. Orion ORP standard (Cat. No. 967901 or 967961) is recommended for testing an ORP electrode.
  - c. A prepared water-saturated air calibration sleeve is recommended for testing RDO optical dissolved oxygen and polarographic dissolved oxygen probes.
7. The meter will perform the stability test and show the mV per minute or % per minute drift and noise on the display.
8. The meter will display *Stability Test Passed* or *Stability Test Failed*. Press **f1 (esc)** or  to return to the measurement mode.



## Meter Factory Reset

After a factory reset is performed, all of the meter settings will be reset to the factory defaults and the data log, calibration log and methods will be deleted.

1. In the measurement mode, press .
2. Press , ,  or  to highlight *Diagnostics* and press **f3 (select)**.
3. Press  or  to highlight *Factory Reset* and press **f2 (accept)**.
4. Press **f2 (yes)** to reset the meter.
5. The meter will pause, power off and restart with the factory default settings.

## Meter User Reset

After a user reset is performed, all of the meter setup menu settings will be reset to the defaults; however, the data log, calibration log and methods will be retained.

1. In the measurement mode, press .
2. Press , ,  or  to highlight *Diagnostics* and press **f3 (select)**.
3. Press  or  to highlight *User Reset* and press **f2 (accept)**.
4. Press **f2 (yes)** to reset the meter.
5. The meter will pause and then return to the measurement mode with the default setup menu settings.

## About Meter

1. In the measurement mode, press .
2. Press , ,  or  to highlight *Diagnostics* and press **f3 (select)**.
3. Press  or  to highlight *About Meter* and press **f2 (accept)**.
4. The meter model, measurement parameters, serial number and software revision will be displayed.
5. Press **f1 (back)** to return to the diagnostics menu or press  to return to the measurement mode.

## Assistance

After troubleshooting all components of your measurement system, contact Technical Support. Within the United States call 1.800.225.1480 and outside the United States call 978.232.6000 or fax 978.232.6031. In Europe, the Middle East and Africa, contact your local authorized dealer. For the most current contact information, visit [www.thermoscientific.com/water](http://www.thermoscientific.com/water).

## Warranty and Registration

To register your meter and for the most current warranty information, visit [www.thermoscientific.com/water](http://www.thermoscientific.com/water).

## Ordering Information

<b>Orion Star A200 Series Benchtop Meters</b>	
<b>Cat. No.</b>	<b>Description</b>
<b>STARA2110</b>	Star A211 pH Benchtop Meter with Electrode Stand
<b>STARA2115</b>	Star A211 pH Benchtop Meter with Electrode Stand; 8302BNUMD ROSS pH/ATC Triode; 810199 ROSS pH Buffer Kit
<b>STARA2120</b>	Star A212 Conductivity Benchtop Meter with Electrode Stand
<b>STARA2125</b>	Star A212 Conductivity Benchtop Meter with Electrode Stand; 013005MD Conductivity Cell; 011007 Conductivity 1413 $\mu$ S/cm Standard
<b>STARA2126</b>	Star A212 Conductivity Benchtop Meter with Electrode Stand; 013016MD Conductivity Cell with Detachable Flow Through Cell; 011008 Conductivity 100 $\mu$ S/cm Standard
<b>STARA2130</b>	Star A213 RDO/DO Benchtop Meter with Electrode Stand
<b>STARA2135</b>	Star A213 RDO/DO Benchtop Meter with Electrode Stand; 083005MD Polarographic DO Probe with Calibration Sleeve; 080513 Probe Maintenance Kit; BOD Funnel, Stirrer and Adapter
<b>STARA2136</b>	Star A213 RDO/DO Benchtop Meter with Electrode Stand; 086030MD AUTO-STIR DO/BOD Probe; 080514 Polarographic Electrolyte Solution; 080513 Probe Maintenance Kit
<b>STARA2140</b>	Star A214 pH/ISE Benchtop Meter with Electrode Stand
<b>STARA2145</b>	Star A214 pH/ISE Benchtop Meter with Electrode Stand; 8102BNUWP ROSS Ultra pH Electrode; 927007MD ATC Probe; 096019 Stirrer Probe; 810199 ROSS pH Buffer Kit
<b>STARA2146</b>	Star A214 pH/ISE Benchtop Meter with Electrode Stand; 8102BNUWP ROSS Ultra pH Electrode; 927007MD ATC Probe; 9512HPBNWP High-Performance Ammonia Electrode; 096019 Stirrer Probe; 951007 Ammonia 1000ppm Standard; 951210 Low-level Ammonia ISA; 951213 Ammonia Electrode Storage Solution
<b>STARA2147</b>	Star A214 pH/ISE Benchtop Meter with Electrode Stand; 8102BNUWP ROSS Ultra pH Electrode; 927007MD ATC Probe; 9609BNWP Fluoride Electrode; 096019 Stirrer Probe; 040906 Fluoride 1ppm with TISAB II Standard; 040907 Fluoride 2ppm with TISAB II Standard; 040908 Fluoride 10ppm with TISAB II Standard; 940909 TISAB II
<b>STARA2148</b>	Star A214 pH/ISE Benchtop Meter with Electrode Stand; 8102BNUWP ROSS Ultra pH Electrode; 927007MD ATC Probe; 8611BNWP ROSS Sodium Electrode with Sodium Standards, Reagents and Solutions; 096019 Stirrer Probe
<b>STARA2150</b>	Star A215 pH/Conductivity Benchtop Meter with Electrode Stand
<b>STARA2155</b>	Star A215 pH/Conductivity Benchtop Meter with Electrode Stand; 8157BNUMD ROSS pH/ATC Triode; 013005MD Conductivity Cell; 810199 ROSS pH Buffer Kit; 011007 Conductivity 1413 $\mu$ S/cm Standard
<b>STARA2160</b>	Star A216 pH/RDO/DO Benchtop Meter with Electrode Stand
<b>STARA2165</b>	Star A216 pH/RDO/DO Benchtop Meter with Electrode Stand; 8157BNUMD ROSS pH/ATC Triode; 083005MD Polarographic DO Probe with Calibration Sleeve; 810199 ROSS pH Buffer Kit; 080513 Probe Maintenance Kit; BOD Funnel, Stirrer and Adapter

<b>Orion Star A200 and Star A300 Series Portable Meters</b>	
<b>Cat. No.</b>	<b>Description</b>
<b>STARA2210</b>	Star A221 pH Portable Meter
<b>STARA2215</b>	Star A221 pH Portable Meter; 8107UWMMD ROSS pH/ATC Triode with 3 Meter Cable; 910410 pH 4.01 Buffer Pouches; 910710 pH 7.00 Buffer Pouches; 911010 pH 10.01 Buffer Pouches; 810001 ROSS Electrode Storage Solution; 911110 Rinse Solution Pouches; STARA-CS Star A Carrying Case; STARA-AR Star A Meter Armor
<b>STARA2220</b>	Star A222 Conductivity Portable Meter
<b>STARA2225</b>	Star A222 Conductivity Portable Meter; 013010MD Conductivity Cell with 3 Meter Cable; 01100710 Conductivity 1413µS/cm Standard Pouches; 911110 Rinse Solution Pouches; STARA-CS Star A Carrying Case; STARA-AR Star A Meter Armor
<b>STARA2230</b>	Star A223 RDO/DO Portable Meter
<b>STARA2235</b>	Star A223 RDO/DO Portable Meter; 087010MD RDO Optical DO Probe with 3 Meter Cable; STARA-CS Star A Carrying Case; STARA-AR Star A Meter Armor
<b>STARA3210</b>	Star A321 pH Portable Meter
<b>STARA3215</b>	Star A321 pH Portable Meter; 8107UWMMD ROSS pH/ATC Triode with 3 Meter Cable; 910410 pH 4.01 Buffer Pouches; 910710 pH 7.00 Buffer Pouches; 911010 pH 10.01 Buffer Pouches; 810001 ROSS Electrode Storage Solution; 911110 Rinse Solution Pouches; STARA-CS Star A Carrying Case; STARA-AR Star A Meter Armor
<b>STARA3220</b>	Star A322 Conductivity Portable Meter
<b>STARA3225</b>	Star A322 Conductivity Portable Meter; 013010MD Conductivity Cell with 3 Meter Cable; 01100710 Conductivity 1413µS/cm Standard Pouches; 911110 Rinse Solution Pouches; STARA-CS Star A Carrying Case; STARA-AR Star A Meter Armor
<b>STARA3230</b>	Star A323 RDO/DO Portable Meter
<b>STARA3235</b>	Star A323 RDO/DO Portable Meter; 087010MD RDO Optical DO Probe with 3 Meter Cable; STARA-CS Star A Carrying Case; STARA-AR Star A Meter Armor
<b>STARA3240</b>	Star A324 pH/ISE Portable Meter
<b>STARA3245</b>	Star A324 pH/ISE Portable Meter; 8107UWMMD ROSS pH/ATC Triode with 3 Meter Cable; 910410 pH 4.01 Buffer Pouches; 910710 pH 7.00 Buffer Pouches; 911010 pH 10.01 Buffer Pouches; 810001 ROSS Electrode Storage Solution; 911110 Rinse Solution Pouches; STARA-CS Star A Carrying Case; STARA-AR Star A Meter Armor
<b>STARA3250</b>	Star A325 pH/Conductivity Portable Meter
<b>STARA3255</b>	Star A325 pH/Conductivity Portable Meter; 8107UWMMD ROSS pH/ATC Triode with 3 Meter Cable; 013010MD Conductivity Cell with 3 Meter Cable; 910410 pH 4.01 Buffer Pouches; 910710 pH 7.00 Buffer Pouches; 911010 pH 10.01 Buffer Pouches; 810001 ROSS Electrode Storage Solution; 01100710 Conductivity 1413µS/cm Standard Pouches; 911110 Rinse Solution Pouches; STARA-CS Star A Carrying Case; STARA-AR Star A Meter Armor
<b>STARA3260</b>	Star A326 pH/RDO/DO Portable Meter
<b>STARA3265</b>	Star A326 pH/RDO/DO Portable Meter; 8107UWMMD ROSS pH/ATC Triode with 3 Meter Cable; 087010MD RDO Optical DO Probe with 3 Meter Cable; 910410 pH 4.01 Buffer Pouches; 910710 pH 7.00 Buffer Pouches; 911010 pH 10.01 Buffer Pouches; 810001 ROSS Electrode Storage Solution; STARA-CS Star A Carrying Case; STARA-AR Star A Meter Armor
<b>STARA3290</b>	Star A329 pH/ISE/Conductivity/RDO/DO Portable Meter
<b>STARA3295</b>	Star A329 pH/ISE/Conductivity/RDO/DO Portable Meter; 8107UWMMD ROSS pH/ATC Triode with 3 Meter Cable; 013010MD Conductivity Cell with 3 Meter Cable; 087010MD RDO Optical DO Probe with 3 Meter Cable; 910410 pH 4.01 Buffer Pouches; 910710 pH 7.00 Buffer Pouches; 911010 pH 10.01 Buffer Pouches; 810001 ROSS Electrode Storage Solution; 01100710 Conductivity 1413µS/cm Standard Pouches; 911110 Rinse Solution Pouches; STARA-CS Star A Carrying Case; STARA-AR Star A Meter Armor

Ordering Information (cont.)

<b>Orion Star A Series Accessories and Electrodes</b>	
<b>Cat. No.</b>	<b>Description</b>
<b>STARA-BEA</b>	Orion Star A Series Electrode Arm and Holder (Attaches to base of meter or STARA-HB base)
<b>STARA-HB</b>	Orion Star A Series Electrode Stand Base Only (Use when electrode arm is not attached to meter)
<b>STARA-CS</b>	Orion Star A Series Portable Hard Carrying Case
<b>STARA-AR</b>	Orion Star A Series Portable Meter Armor with Stand, includes one pH Electrode Holder with Storage Sleeve and one Conductivity Cell and DO Probe Holder
<b>STARA-ESPH</b>	Orion Star A Series pH Electrode Holder for Meter Armor (requires pH storage sleeve, purchase separately)
<b>STARA-ESCD</b>	Orion Star A Series Conductivity Cell and DO Probe Holder for Meter Armor
<b>1010003</b>	Orion Star A Series Power Adapter for Benchtop and Portable Meters
<b>8102BNUWP</b>	ROSS Ultra Glass Refillable pH Electrode
<b>8302BNUMD</b>	ROSS Glass Refillable pH/ATC Triode
<b>8157BNUMD</b>	ROSS Refillable Epoxy pH/ATC Triode
<b>8107UWMMD</b>	ROSS Gel-filled Epoxy pH/ATC Triode with 3 Meter Cable
<b>927005MD</b>	Epoxy Steel ATC Probe
<b>927007MD</b>	Stainless Steel ATC Probe
<b>9179BNMD</b>	Gel-filled Epoxy ORP/ATC Triode
<b>9180BNMD</b>	Refillable Epoxy ORP/ATC Triode
<b>9512HPBNWP</b>	High-Performance Ammonia Electrode
<b>9609BNWP</b>	Fluoride Electrode
<b>8611BNWP</b>	ROSS Sodium Electrode with Sodium Standards, Reagents and Solutions
<b>013005MD</b>	DuraProbe Epoxy 4-Cell (K=0.475) Conductivity Cell
<b>013010MD</b>	DuraProbe Epoxy 4-Cell (K=0.475) Conductivity Cell with 3 Meter Cable
<b>013020MD</b>	DuraProbe Epoxy 4-Cell (K=0.475) Conductivity Cell with 6 Meter Cable
<b>013025MD</b>	DuraProbe Epoxy 4-Cell (K=0.475) Conductivity Cell with 10 Meter Cable
<b>013016MD</b>	Steel 2-Cell (K=0.1) Conductivity Cell with Detachable Flow Through Cell
<b>083005MD</b>	Polarographic DO Probe with Calibration Sleeve
<b>083010MD</b>	Polarographic DO Probe with Calibration Sleeve and 3 Meter Cable
<b>083025MD</b>	Polarographic DO Probe with Calibration Sleeve and 10 Meter Cable
<b>086030MD</b>	AUTO-STIR DO/BOD Probe
<b>087010MD</b>	RDO Optical DO Probe with 3 Meter Cable
<b>087020MD</b>	RDO Optical DO Probe with 6 Meter Cable
<b>087030MD</b>	RDO Optical DO Probe with 10 Meter Cable
<b>096019</b>	Stirrer Probe for Star A200 Series Benchtop Meters



*This page intentionally left blank.*

---

## Chapter 11 Meter Compliance

### Notice of Compliance

This equipment generates, uses, and can radiate radio frequency energy and if not installed and used in accordance with the instruction manual, may cause interference to radio communications. It has been tested and found to comply with the limits for a Class A computing device pursuant to Subpart J of Part 15 of FCC Rules, which are designed to provide reasonable protection against such interference when operated in a commercial environment. Operation of this equipment in a residential area is likely to cause interference in which case the user, at his own expense, will be required to take whatever measures may be required to correct the interference.

“This digital apparatus does not exceed the (Class A) limits for radio noise emissions from digital apparatus set out in the Radio Interference Regulations of the Canadian Department of Communications.”

“Le present appareil numerique n’emet pas de bruits radioelectriques depassant les limites applicables aux appareils numeriques (de la class A) prescrites dans le Reglement sur le brouillage radioelectrique edicte par le ministere des Communications du Canada.”

### WEEE Compliance



This product is required to comply with the European Union’s Waste Electrical & Electronic Equipment (WEEE) Directive 2002/96/EC. It is marked with the symbol on the left.

Thermo Fisher Scientific has contracted with one or more recycling/disposal companies in each EU Member State and this product should be disposed of or recycled through them. Further information on compliance with these directives, the recyclers in your country, and information on Thermo Scientific Orion products that may assist the detection of substances subject to the RoHS Directive are available at [www.thermoscientific.com](http://www.thermoscientific.com).

## Declaration of Conformity

**Manufacturer:** Thermo Fisher Scientific Inc.

**Address:** Ayer Rajah Crescent  
Blk 55 #04-16/24  
Singapore 139949  
Singapore

### Hereby declares that the following products:

Benchtop meters are rated 100 to 240 VAC, 50/60 Hz, 0.5A.  
Handheld meters use four non-rechargeable AA batteries.

#### Benchtop Meters

Orion Star A211 pH  
Orion Star A212 Conductivity  
Orion Star A213 RDO/DO  
Orion Star A214 pH/ISE  
Orion Star A215 pH/Conductivity  
Orion Star A216 pH/RDO/DO

#### Portable Meters

Orion Star A221 pH  
Orion Star A222 Conductivity  
Orion Star A223 RDO/DO  
Orion Star A321 pH  
Orion Star A322 Conductivity  
Orion Star A323 RDO/DO  
Orion Star A324 pH/ISE  
Orion Star A325 pH/Conductivity  
Orion Star A326 pH/RDO/DO  
Orion Star A329 pH/ISE/Conductivity/RDO/DO

### Equipment Class:

Measurement, control and laboratory  
Orion Star A-series meters are EMC Class A

### Conforms with the following directives and standards:

**EN61326-1:2006**

#### Electromagnetic Compatibility (EMC Directive)

Electrical equipment for measurement,  
control and laboratory use - EMC requirements

**EN61010-1:2001**

#### Safety Standards

**UL61010-1:2004**

Safety requirements for electrical equipment for measurement,  
control and laboratory use - general requirements

**CAN/CSA C22.2 No. 61010-1-04**



---

Cheow Kwang Chan  
QA/Regulatory Manager

Place and Date of Issue:  
June 15, 2011  
Singapore

## Meter Specifications

<b>Meter Operating Conditions</b>	
Operating Ambient Temperature	5 to 45 °C
Operating Relative Humidity	5 to 85 %, non-condensing
Storage Temperature	-20 to +60 °C
Storage Relative Humidity	5 to 85 %, non-condensing
Pollution	Degree 2
Overvoltage	Category II
Weight	Portable: 450g Benchtop: 850g
Size	Portable: 5.9cm (H) x 10.5cm (W) x 23.1cm (D) Benchtop: 9.3cm (H) x 18.0cm (W) x 23.6cm (D)
Regulatory and Safety	CE, TUV 3-1, FCC Class A
Power Rating	DC Input: 9 VDC 1A Battery: 4 x AA
Shock and Vibration	Vibration: shipping/handling per ISTA #1A. Shock: drop test in packaging per ISTA #1A
Enclosure (designed to meet)	Portable: IP67 Benchtop: IP54
Warranty	3 year meter replacement

<b>Universal Power Adapter Operating Conditions</b>	
Operating Ambient Temperature	0 to 50 °C
Operating Relative Humidity	0 to 90 %, non-condensing
Storage Temperature	-20 to +75 °C
Storage Relative Humidity	0 to 90 %, non-condensing
Pollution	Degree 2
Overvoltage	Category II

<b>Meter Parameter Specifications</b>	
<b>pH</b>	
Range	-2.000 to 20.000
Resolution	0.1, 0.01, 0.001
Relative Accuracy	± 0.002
Calibration Points	Up to 5
Calibration Editing	Yes
<b>mV/RmV</b>	
Range	± 2000.0 mV
Resolution	0.1, 1
Relative Accuracy	±2%
E <sub>H</sub> ORP Mode	Yes
<b>Dissolved Oxygen Measurement</b>	
<b>Concentration - Polarographic</b>	
Range	0 to 90 mg/L
Resolution	0.01, 0.1
Relative Accuracy	± 0.2
<b>% Saturation - Polarographic</b>	
Range	0 to 600 % sat.
Resolution	0.1, 1
Relative Accuracy	± 2%
<b>Concentration - RDO</b>	
Range	0 to 50 mg/L
Resolution	0.01, 0.1
Relative Accuracy	± 0.1 mg/L up to 8 mg/L; ± 0.2 mg/L from 8 to 20 mg/L; 10% of reading from 20 to 50 mg/L

<b>% Saturation - RDO</b>	
Range	0 to 500 % sat.
Resolution	0.1, 1
Relative Accuracy	± 2%
Automatic Barometric Pressure Correction	450.0 to 850.0 mm Hg
Salinity Factor Correction	Manual; 0 to 45 ppt
Calibration Features	Water saturated air, air saturated water, manual (Winkler) and zero point
Probe Characteristics	Polarographic or RDO
<b>Temperature Measurement</b>	
Range	0 to 50°C
Resolution	0.1
Relative Accuracy	± 0.1
Offset Calibration	1 point
<b>Data Logging</b>	
Number of Points	Star A216: 2000 with time and date stamp Star A326: 5000 with time and date stamp
Log Function	Manual, Ready (AUTO-READ), Timed
Log Edit	Delete individual points, group of points or all
<b>Inputs</b>	
pH Electrode	BNC, reference pin
ATC Probe	8-pin MiniDIN
DO with Built-in Temperature Probe	9-pin MiniDIN
<b>Output</b>	
	RS232, USB
<b>Power</b>	
AC Adapter	Universal, 110 - 240 VAC (included with Star A216)
Battery Power	Four Alkaline AA (included with Star A326)
Battery Life	2000 hours

*This page intentionally left blank.*

---

## Appendix 1 Advanced Meters Features

### Automatic pH Buffer Recognition Feature

The Orion Star A200 and Star A300 series pH meters are capable of automatically recognizing pH 1.68, 4.01, 7.00, 10.01 and 12.46 buffers or pH 1.68, 4.01, 6.86, and 9.18 buffers during a pH calibration, depending on the pH buffer set that is selected in the setup menu. During a calibration, the meter uses the selected buffer set and the raw mV reading of the pH electrode in the buffer to recognize and display the buffer value at the measured temperature. The raw mV reading of the pH electrode in the buffer must be about  $\pm 30$  mV from the theoretical mV reading of the buffer in order for the meter to automatically recognize the buffer.

USA pH Buffer Set		DIN pH Buffer Set	
Buffer	mV Range	Buffer	mV Range
1.68	+285 to +345 mV	1.68	+285 to +345 mV
4.01	+207 to +147 mV	4.01	+207 to +147 mV
7.00	-30 to +30 mV	6.86	+38 to -22 mV
10.01	-207 to -147 mV	9.18	-99 to -159 mV
12.46	-293 to -353 mV		

#### *Testing a pH Electrode for Automatic Buffer Recognition*



To verify that the raw mV reading of the pH electrode in use is  $\pm 30$  mV from the theoretical mV reading of the buffer, and therefore verify that the pH electrode in use is capable of performing automatic buffer recognition, perform the following procedure.

1. Set the measurement mode to mV. Prepare the pH electrode according to the instructions in the pH electrode user guide.
2. Rinse the pH electrode with distilled water, blot it dry with a lint-free tissue and place the pH electrode into a pH 4.01 buffer at approximately 25 °C.
3. Wait for the measurement to stabilize and record the mV value of the pH 4.01 buffer when the meter indicates that the measurement is stable. The read type selected in the setup menu will determine how the mV measurements are displayed by the meter.
4. Remove the pH electrode from the pH 4.01 buffer.
5. Rinse the pH electrode with distilled water, blot it dry with a lint-free tissue and place the pH electrode into a pH 7.00 buffer at approximately 25 °C.
6. Wait for the measurement to stabilize and record the mV value of the pH 7.00 buffer when the meter indicates that the measurement is stable.
7. The mV reading of the pH electrode in pH 4.01 buffer should be in the range of +207 to +147 mV and the mV reading of the pH electrode in pH 7.00 buffer should be in the range of -30 to +30 mV. If the mV readings of the pH electrode are in the correct ranges, the pH electrode is capable of performing automatic buffer recognition. If the mV readings of the pH electrode are not in the correct ranges, the values of the pH buffers will need to be manually entered during a pH calibration.



## Electrode Condition Icon

The electrode condition icon indicates the performance of the pH electrode, based on the last saved calibration and electrode measurement stability.

Icon	pH Electrode Definition of Icon
	Electrode condition is good and the electrode slope is 90 to 110 %.
	Electrode condition is fair and the electrode slope is 80 to 120 %.
	Electrode condition is bad and the electrode slope is less than 80 % or greater than 120 %. Consult the electrode user guide for instructions on how to clean, condition and troubleshoot the electrode.

## Multipoint Calibration Curve Feature

The Orion Star A200 and Star A300 series pH meters utilize a point-to-point scheme for multipoint calibrations in the pH mode. In this technique, straight line segments are drawn between each successive pair of calibration points. Separate slope and  $E_o$  values are calculated using the adjacent pair of data points. For example, in a five point calibration, four slopes and five  $E_o$  values are calculated to correspond to the four line segments that connect the data. pH values for samples are calculated according to the segment that their potential values fall into. Those above or below the range of calibration are calculated by extrapolation from the top or bottom most segment.

The displayed slope is an average slope of the separate segments. The slope may be outside the range normally expected for an electrode. For example, if the slope of one segment is low, then the average will be lower than theoretical, even though the response may be Nernstian over most of the range.

The figure below is an example of a typical calibration curve using this method.

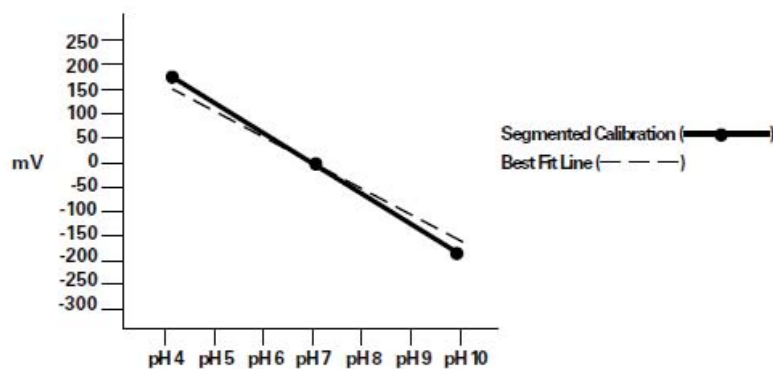

## Dissolved Oxygen Barometric Pressure Compensation

The Orion Star A200 and Star A300 series RDO/DO meters have an internal barometer that is used for pressure compensated dissolved oxygen readings. The meter can also use manual barometric pressure compensation if dissolved oxygen is measured with a submerged probe or in a pressurized vessel. The pressure must be entered as mm Hg.

$$1 \text{ mm Hg} = 0.03937 \text{ inch Hg} = 1.3332 \text{ hPa (mBar)} = 0.01934 \text{ PSI.}$$

## Dissolved Oxygen Salinity Correction

Automatic salinity correction for dissolved oxygen readings reported as mg/L is available on the Orion Star A329 pH/ISE/conductivity/RDO/DO meter that has both dissolved oxygen and conductivity measurement modes. The meter uses the conductivity value read by the conductivity cell to calculate the salinity correction factor and applies the factor to dissolved oxygen readings reported as mg/L.

Manual salinity correction can be used for dissolved oxygen readings reported as mg/L on all Orion Star A200 and Star A300 series RDO/DO meters. The manual salinity correction factor must be entered as ppt (parts per thousand).

Conductivity at 20 °C (mS/cm)	Salinity Correction Value (ppt)	Conductivity at 20 °C (mS/cm)	Salinity Correction Value (ppt)	Conductivity at 20 °C (mS/cm)	Salinity Correction Value (ppt)
5	3	20	13	35	25
6	4	21	14	36	25
7	4	22	15	37	26
8	5	23	15	38	27
9	6	24	16	39	28
10	6	25	17	40	29
11	7	26	18	42	30
12	8	27	18	44	32
13	8	28	19	46	33
14	9	29	20	48	35
15	10	30	21	50	37
16	10	31	22	52	38
17	11	32	22	54	40
18	12	33	23	56	42
19	13	34	24		

This table was calculated from the International Oceanographic Tables, Vol. 1, National Institute of Oceanography of Great Britain, Womley, Godaming, Surrey, England and Unesco, Paris 1971.

*This page intentionally left blank.*

# Water Analysis Instruments



## North America

166 Cummings Center  
Beverly, MA 01915 USA  
Toll Free: 1-800-225-1480  
Tel: 1-978-232-6000  
info.water@thermo.com

## Netherlands

Tel: (31) 033-2463887  
info.water.uk@thermo.com

## India

Tel: (91) 22-4157-8800  
wai.asia@thermofisher.com

## Japan

Tel: (81) 045-453-9175  
wai.asia@thermofisher.com

## China

Tel: (86) 21-68654588  
wai.asi@thermofisher.com

## Singapore

Tel: (65) 6778-6876  
wai.asia@thermofisher.com

## Australia

Tel: (613) 9757-4300  
in Australia (1300) 735-296  
InfoWaterAU@thermofisher.com  
www.thermoscientific.com/water

© 2011 Thermo Fisher Scientific Inc. All rights reserved.

68X576706 RevA 10-11