

Thermo Scientific Orion Star A215 Benchtop and Star A325 Portable pH/Conductivity Meters

Reference Guide



Ross and the COIL trade dress are trademarks of Thermo Fisher Scientific, Inc. and its subsidiaries.

AQUAfast, AQUASensors, BOD AutoEZ, ionplus, KNIpHE, LogR, No Cal, ORION, perpHect, PerpHecT, pHISA, pHuture, Pure Water, Sage, ROSS, ROSS Ultra, Sure-Flow, Titrator PLUS, and TURBO2 are registered trademarks of Thermo Fisher Scientific, Inc. and its subsidiaries.

A+, All in One, Aplus, AUTO-BAR, AUTO-CAL, Auto-ID, AUTO-READ, AUTO-STIR, Auto-Test, AutoTraction, CISA, digital LogR, DuraProbe, EZ Startup, ISEasy, Low Maintenance Triode, Minimum Stir Requirement, MSR, NISS, Optimum Results, Orion Dual Star, Orion Star, SAOB, SMART AVERAGING, SMART STABILITY, Star LogR, Star Navigator 21, Stat Face, Triode are trademarks of Thermo Fisher Scientific, Inc. and its subsidiaries.

Guaranteed Success and The Technical Edge are service marks of Thermo Fisher Scientific, Inc. and its subsidiaries.

© 2011 Thermo Fisher Scientific Inc. All rights reserved. All trademarks are the property of Thermo Fisher Scientific, Inc. and its subsidiaries.

The specifications, descriptions, drawings, ordering information and part numbers within this document are subject to change without notice.

This publication supersedes all previous publications on this subject.

Thermo Scientific Orion Star A215 Benchtop and Star A325 Portable pH/Conductivity Meters

Chapter 1	Introduction	1
Chapter 2	Meter Overview	3
	Meter Connections and Inputs	3
	<i>Power Source</i>	3
	<i>Electrodes and Other Connections</i>	4
	<i>Connecting Electrode Arm to the Benchtop Meter</i>	5
	Meter Display	6
	Meter Keypad	7
	Meter Maintenance	8
Chapter 3	Meter Setup	9
	Navigating the Setup Menu	9
	Setup Menu Overview	9
	<i>pH Channel Menu</i>	10
	<i>COND Channel Menu</i>	12
	<i>Settings Menu</i>	14
	<i>View Log Menu</i>	15
	<i>Diagnostics Menu</i>	15
Chapter 4	pH, RmV and ORP Calibration	17
	pH Calibration	17
	<i>Calibration Editing</i>	18
	RmV Calibration	18
	ORP Calibration	19
Chapter 5	Conductivity Calibration	21
	Automatic and Direct Calibration	21
	<i>Calibration Editing</i>	22
	Manual Conductivity Calibration	22
Chapter 6	Temperature Calibration	23
Chapter 7	Measurement	25
Chapter 8	Methods	27
	Saving the Current Meter Settings as a New Method	27
	Loading an Existing Method	27
	Editing, Copying or Deleting an Existing Method	28

Chapter 9	Data Storage and Retrieval	29
	Data Storage Settings	29
	<i>Read Type Selection</i>	29
	<i>Computer and Printer Export Settings</i>	30
	<i>Data Log Settings</i>	30
	Viewing the Calibration Log and Data Log	31
	<i>Viewing the Calibration Log</i>	31
	<i>Viewing the Data Log</i>	31
	Exporting the Data Log to a Computer or Printer	32
	Clearing the Data Log	33
	Interfacing a Printer	34
	Interfacing a Computer	34
Chapter 10	Customer Services	35
	Meter Errors and Recommended Actions	35
	Meter Self Test and Checkout	36
	<i>Meter Self Test</i>	36
	<i>Meter Checkout (pH)</i>	37
	<i>Meter Checkout (Conductivity)</i>	37
	Electrode Stability Test	38
	Meter Factory Reset	38
	Meter User Reset	39
	About Meter	39
	Assistance	39
	Warranty and Registration	39
	Ordering Information	40
Chapter 11	Meter Compliance	43
	Notice of Compliance	43
	WEEE Compliance	43
	Declaration of Conformity	44
	Meter Specifications	45
Appendix 1	Advanced Meter Features	48
	Automatic pH Buffer Recognition Feature	48
	<i>Testing a pH Electrode for Automatic Buffer Recognition</i> .	48
	Electrode Condition Icon	49
	Multipoint Calibration Curve Feature	50
	Conductivity Temperature Compensation and Reference Temperature	51
	Conductivity and Total Dissolved Solids (TDS)	51
	Conductivity Automatic Calibration	51

This page intentionally left blank.

Chapter 1 Introduction

Thank you for your purchase of the Orion Star A215 benchtop pH/conductivity or Star A325 portable pH/conductivity meter. These meters are capable of measuring pH, mV, relative mV (RmV), ORP, conductivity, TDS, salinity, resistivity, and temperature in °C or °F.

The Orion Star A215 benchtop pH/conductivity meters feature

- pH range of -2.000 to 20.000 pH units with 0.1, 0.01 or 0.001 resolution and up to 5 calibration points
- mV, relative mV and ORP range of -2000.0 to +2000.0 mV with 0.1 mV resolution
- Conductivity range of 0.00 to 3000 mS/cm with up to four significant figure resolution and up to five calibration points
- TDS (total dissolved solids) range of 0 to 200 ppt with up to four significant figure resolution
- Salinity range of 0.01 to 42 ppt practical salinity or 0.01 to 80.0 ppt NaCl equivalent with 0.10 ppt resolution
- Resistivity range of 2 ohms to 100 mega-ohms with 2 ohm resolution
- AUTO-READ, continuous (with hold option) and timed measurement modes
- calibration editing
- 2000 point data log
- manual, ready (AUTO-READ) and timed data logging functions
- IP54-rated dust and splash resistant housing

The Orion Star A325 portable pH/conductivity meters feature

- pH range of -2.000 to 20.000 pH units with 0.1, 0.01 or 0.001 resolution and up to 5 calibration points
- mV, relative mV and ORP range of -2000.0 to +2000.0 mV with 0.1 mV resolution
- Conductivity range of 0.00 to 3000 mS/cm with up to four significant figure resolution and up to five calibration points
- TDS (total dissolved solids) range of 0 to 200 ppt with up to four significant figure resolution
- Salinity range of 0.01 to 42 ppt practical salinity or 0.01 to 80.0 ppt NaCl equivalent with 0.10 ppt resolution
- Resistivity range of 2 ohms to 100 mega-ohms with 2 ohm resolution
- AUTO-READ, continuous (with hold option) and timed measurement modes
- calibration editing
- 5000 point data log
- manual, ready (AUTO-READ) and timed data logging functions
- IP67-rated dust-proof and waterproof housing

Please read this reference guide thoroughly. Any use outside of these instructions may invalidate your warranty and cause permanent damage to the meter.

This page intentionally left blank.

Chapter 2 Meter Overview

Meter Connections and Inputs

Power Source

1. Power adapter (included with benchtop meters, sold separately for portable meters)
 - a. Select the appropriate wall socket plug plate.
 - b. Slide off the clear plastic cover from the plug plate.
 - c. Slide the plug plate into the groove on the back of the power adapter.
 - d. Connect the power adapter to the meter and power outlet.

2. Batteries (included with portable meters, sold separately for benchtop meters)
 - a. Select four AA alkaline batteries.
 - b. Confirm that the meter is powered off.
 - c. Remove the battery compartment cover.
 - i. Benchtop meters – push down on the battery compartment tab and lift the battery cover up.
 - ii. Portable meters – loosen the screws holding the battery cover, release the top portion of the battery cover from the meter (use a coin or your finger) and release the bottom portion of the battery cover.
 - d. Orientate the batteries as shown in the battery compartment housing and insert batteries.
 - e. Replace the battery compartment cover. For portable meters – replace the screws.

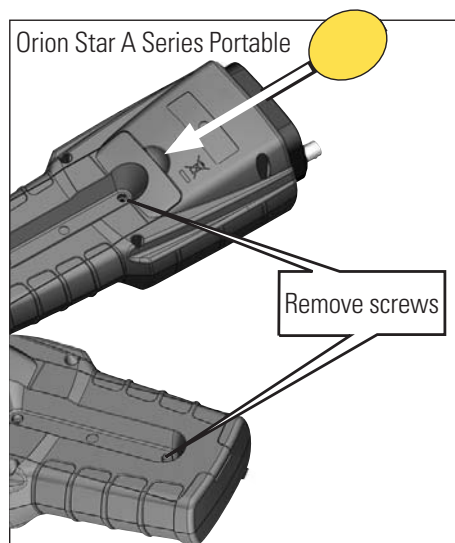
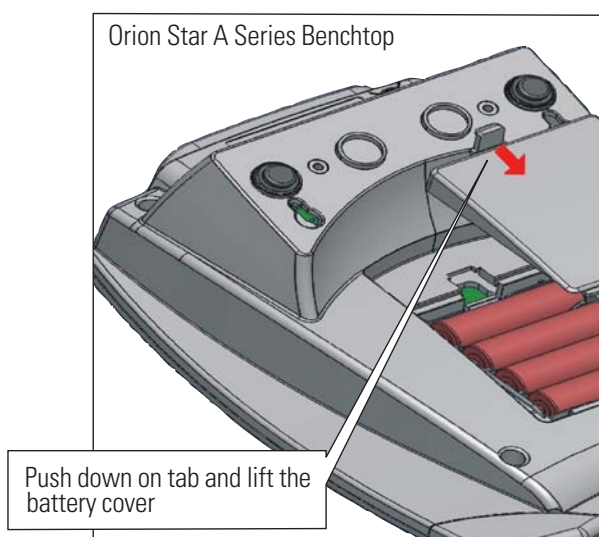

Electrodes and Other Connections

1. Prepare the pH electrode, conductivity cell and any other applicable electrodes according to the directions in the electrode user guide.
2. Connect the appropriate items as labeled on the meter and as shown in the figure below:

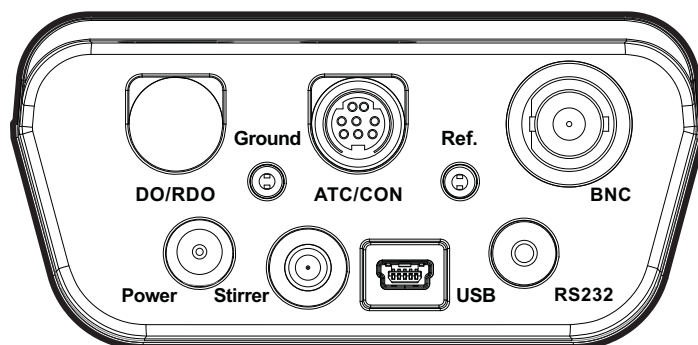

Star A215 Meter Back Panel

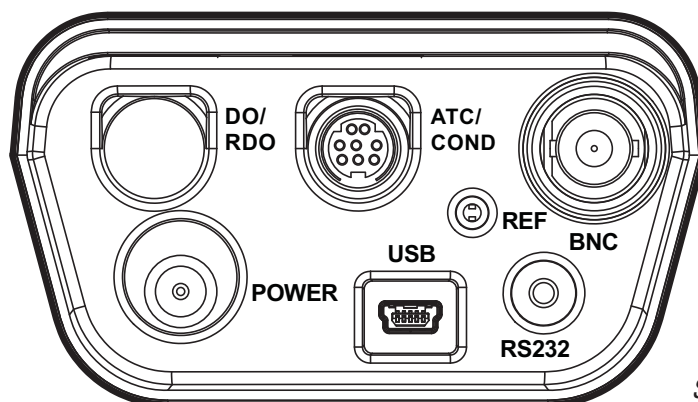

Star A325 Meter Back Panel

- BNC – Input for pH electrode or ORP/redox electrode with BNC or waterproof BNC connector.
- REF – Input for reference electrode with standard 2.5 mm pin-tip connector.
- ATC/CON – Input for conductivity cell or ATC probe with 8 pin MiniDIN connector.
- Ground – Input for a ground wire with a standard pin-tip connector. *Orion Star A215 benchtop meters only.*
- Power – Input for the power adapter.
- Stirrer – Input for the stirrer probe, Cat. No. 096019. *Orion Star A215 benchtop meters only.*
- USB – Input for the USB cable, used to connect the meter to a printer or computer.
- RS232 – Input for the RS232 cable, used to connect the meter to a printer or computer.



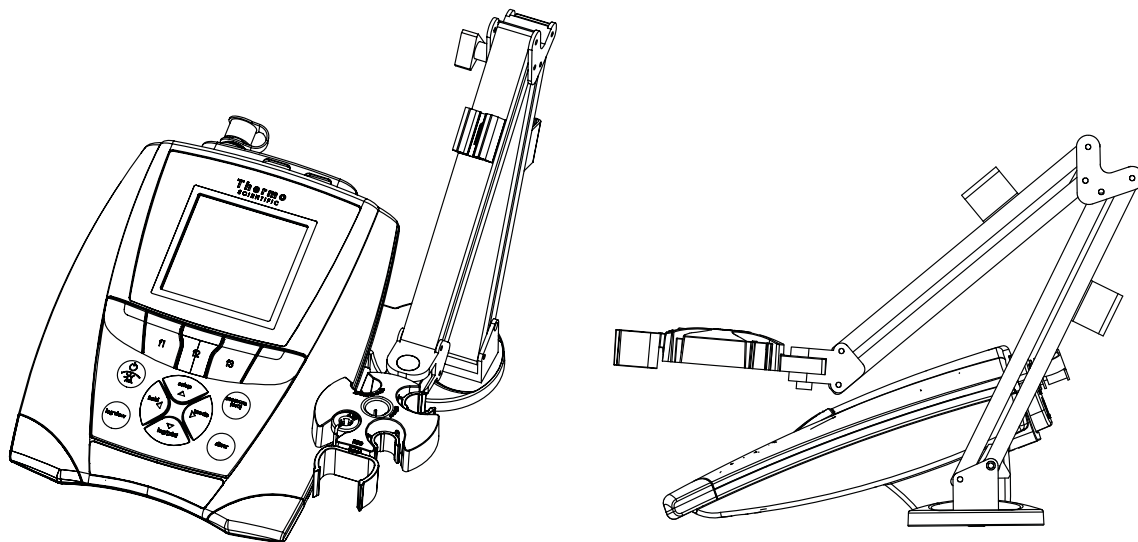













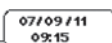









Connecting Electrode Arm to an Orion Star A Series Benchtop Meter



Orion Star A series benchtop meters include an electrode arm that can be attached to either side of the meter.

1. Unpack the electrode arm and base.
2. Choose the side of the meter to attach the arm.
3. Use a clean surface and turn the meter over.
4. Release the existing screw from the back of the meter.
5. Align the electrode arm base with the circles at the bottom of the meter. The metal post on the electrode arm base should be on the same side as the meter display.
6. Take the screw that was removed and use it to secure the electrode arm base to the meter.
7. Turn the meter over.
8. Place the hole at the bottom of the electrode arm onto the metal post on the electrode arm base.

Meter Display

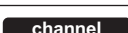
Display Icon	Description
	Shown when the meter is running on AC power.
	Shown when the meter has batteries installed.
	Indicates data is being sent to a computer or printer.
	Indicates data is being sent to the data log.
	Shown when an alarm is set and the alarm value is reached.
	Indicates the meter is set to be interfaced with a printer or computer via the RS232 port.
	Indicates the meter is set to be interfaced with a printer or computer via the USB port.
	Displays the time and date entered in the setup menu.
	Displays the current temperature based on the temperature probe reading or entered temperature value. Shows the origin of the temperature as MAN (entered temperature) or ATC (temperature probe).
	Shown when  is pressed and the displayed measurement is frozen.
	Indicates a calibration was successfully completed. Icon will blink when the calibration alarm is set and the alarm value is reached.
	Indicates the pH electrode condition as good (two bars), fair (one bar) or bad (slash through it), based on the last saved calibration and measurement stability.
	Indicates a method is in use and the number of the method being used.
	Indicates the type of measurement and determines the type of calibration that will be performed.
	Specifies the stability of the electrode as stabilizing or ready .
	Shown when the meter is in AUTO-READ mode. The  icon will blink while the reading is stabilizing and stop blinking when the reading is stable and the measurement is locked on the display.
	Displays the measurement value based on the last saved calibration and current electrode reading. Units are shown to the right of the value.
	Shows the raw millivolt reading of the electrode. pH mode only.
	Shows the buffer values used for the last saved calibration. pH mode only.
	Shows the cell constant set in the last saved manual calibration. Conductivity mode only.
	Shows the conductivity standards used for the last saved automatic or direct calibration. Conductivity mode only.
	Shows the type of temperature compensation in use for conductivity measurements. Conductivity mode only.
	Shows the operator assigned sample ID number.
	Shows the operator assigned user ID number.
	Displays the action that will be performed when f1 is pressed.
	Displays the action that will be performed when f2 is pressed.
	Displays the action that will be performed when f3 is pressed.

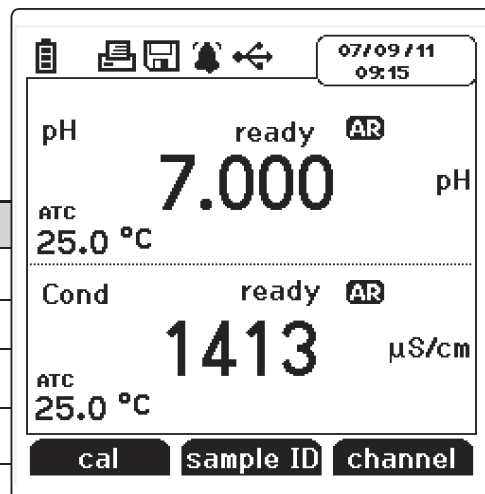

Meter Keypad

Orion Star A200 and A300 Series Portable Keypad

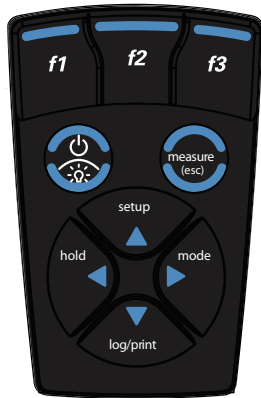

Orion Star A200 Series Benchtop Keypad

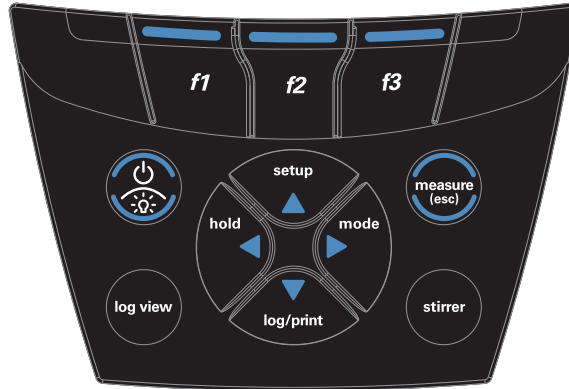

Press the **f1**, **f2** and **f3** function keys to perform the action shown above each key on the display.



Press to turn the meter on.

When the meter is on, press and quickly release to turn the display backlight on or off or hold down to turn the meter off.



In the measurement mode, press to take a measurement.

In the setup, calibration and other menus, press to escape the current menu and return to the measurement mode.



In the measurement mode, press to enter the setup menu.

In the setup, calibration and other menus, press to scroll up through a list of options.



In the continuous measurement mode, press to hold (freeze) the displayed measurement and press again to release (unfreeze) the measurement.

In the setup, calibration and other menus, press to scroll left through a list of options.



In the single channel measurement modes, press to change the displayed measurement mode. Options for channel 1 are pH, mV, RmV (relative mV) or ORP. Options for channel 2 are Cond (conductivity), TDS, Salinity and Res (resistivity).

In the setup, calibration and other menus, press to scroll right through a list of options.



In the measurement mode, press to log or print a measurement.













In the setup, calibration and other menus, press to scroll down through a list of options.



Press to view the data log and calibration log. *Orion Star A215 benchtop meters only.*



Press to start or stop the stirrer probe. *Orion Star A215 benchtop meters only.*















1. Press  to power the meter on. When the meter is on, press and quickly release  to turn the backlight on or off or press and hold  for about three seconds to power the meter off.
2. Press  to exit any meter function and return to the measurement mode.
3. The **f1**, **f2**, and **f3** function keys perform a variety of meter operations. The menu-specific operation is shown above each key on the display. For example, press **f1** in the measurement mode to start a calibration.
4. The , ,  or  keys are used as navigation keys (up, right, down, left) when selecting from a fixed list or grid of meter options. In the measurement mode, these keys are used to access the setup menu, change the measurement mode, manually log or print a measurement and hold (freeze) a displayed measurement in the continuous measurement mode.
5. In the continuous measurement mode, when  is pressed and the measurement is being held (frozen), only the  key will be functional until the measurement is released (unfrozen).
6. Press  to turn on or off the stirrer probe (Cat. No. 096019). *Orion Star A215 benchtop meters only.*
7. Press  to access the calibration log and data log. *Orion Star A215 benchtop meters only.*

Meter Maintenance

For routine meter maintenance, dust and wipe the meter with a damp cloth. If necessary, warm water or a mild water-based detergent can be used. Meter maintenance can be performed on a daily, weekly or monthly basis, as required by the environment in which the meter is operated. Immediately remove any spilled substance from the meter using the proper cleaning procedure for the type of spill.

Chapter 3 Meter Setup

Navigating the Setup Menu



1. In the measurement mode, press  to enter the main setup menu.
2. Press , ,  or  to scroll through the main setup menu options. Press **f3 (select)** to select a main setup menu option.
3. Press  or  to scroll through setup submenu options. Press **f3 (select)** to select a setup submenu option.
4. Perform the appropriate actions to set the desired parameter in the setup submenus.
 - a. To select a value from a list of options, press  or  to highlight the desired value and press **f3 (select)** to set the value.
 - b. To enter a numeric value, use the numeric entry screen.
 - i. Select the value to be entered by pressing **f3 (select)** or **f3 (edit)**. The numeric entry screen will popup on the display.
 - ii. Press , ,  or  to highlight a number, decimal place or negative sign; press **f3 (enter)** to select the highlighted item and repeat until the desired value is shown on the top of the numeric entry screen.
 - iii. Press **f2 (done)** to save the value and exit the numeric entry screen.
5. Press **f1 (back)** and then  to return to the measurement mode at any time.

Setup Menu Overview









pH Channel	COND Channel	Settings	Log View	Diagnostics
Method <hr/> Mode & Settings <ul style="list-style-type: none"> • Measure Mode • Read Type • Resolution • Buffer Group • Stability • Averaging • Alarm Settings • Limit Alarm • Cal Due Alarm <hr/> Temperature <ul style="list-style-type: none"> • Manual Temp Value • Temperature Unit • Temperature Calibration 	Method <hr/> Mode & Settings <ul style="list-style-type: none"> • Measure Mode • Read Type • Cell Type • Cell K • TDS Factory (<i>TDS only</i>) • Type (<i>Salinity only</i>) • Ref Temp • Temp Comp. • Temp Coeff • Stability • Averaging • Limit Alarm • Cal Due Alarm <hr/> Temperature <ul style="list-style-type: none"> • Manual Temp Value • Temperature Unit • Temperature Calibration 	<ul style="list-style-type: none"> • Export Data • Data Log • Date / Time • Language • Key Press Beep • Alarm Beep • Stirrer (<i>Star A215 meters only</i>) • Contrast • Auto Shut Off • User ID • Sample ID 	<ul style="list-style-type: none"> • Data Log • Calibration Log 	<ul style="list-style-type: none"> • Factory Reset • User Reset • Self Test • Stability Test • About Meter

pH Channel Menu

The pH Channel setup menu is used to review and change parameters relating to pH, mV, relative mV and ORP measurements and calibrations.



Main Setup Menu	2nd Level	3rd Level	Menu Options	Menu Description
pH Channel	Method	List of Methods		Menu allows the current meter settings to be saved as a new method, an existing method to be run on the meter, or an existing method to be viewed, edited, copied, deleted or printed.
	Mode and Settings	Measure Mode	<ul style="list-style-type: none"> • pH • mV • RmV • ORP 	Menu used to select the displayed measurement mode, which determines the type of calibration the meter will perform.
		Read Type	<ul style="list-style-type: none"> • Auto • Continuous • Timed 	<p>Menu used to select how the meter will take measurements.</p> <p>Auto (AR) – Press  to take a measurement. When the measurement is stable, it is locked on the display until  is pressed again.</p> <p>Continuous – The measurement is constantly updated on the display and stabilizing or ready is shown to indicate the measurement stability.</p> <p>Timed – Measurements are taken at a set time interval. To enter the time interval, highlight Timed press  to highlight the hours (HH), minutes (MM) or seconds (SS), press f3 (edit) and use the numeric entry screen to change the values.</p>
		Resolution	<ul style="list-style-type: none"> • 1 Decimal Place 0.1 • 2 Decimal Places 0.01 • 3 Decimal Places 0.001 	Menu used to select the resolution for the displayed measurement values.
		Buffer Group	<ul style="list-style-type: none"> • USA • DIN 	Menu used to select the buffer group used for automatic buffer recognition during pH calibrations. USA – pH 1.68, 4.01, 7.00, 10.01, 12.46 buffers DIN – pH 1.68, 4.01, 6.86, 9.18 buffers

pH Channel Menu (cont.)









Main Setup Menu	2nd Level	3rd Level	Menu Options	Menu Description
pH Channel (cont.)	Mode and Settings (cont.)	Stability	<ul style="list-style-type: none"> • Smart Stability • Fast • Medium • Slow 	Menu used to select how the stability of the displayed measurement values is indicated. Smart Stability automatically compensates for measurement conditions and optimizes the meter response time.
		Averaging	<ul style="list-style-type: none"> • Off • Automatic Smart 	Menu used to turn the averaging function on or off. Automatic Smart automatically compensates for measurement conditions and optimizes the meter response time.
		Limit Alarm	<ul style="list-style-type: none"> • Limit Alarm On Off • Alarm Settings Low High High/Low • High Limit • Low Limit 	Menu used to turn the limit alarm on or off and to set the limit alarm parameters. The limit alarm is triggered if the measurement goes above a high value and/or below a low value set by the operator. Press  or  to change the setting on each line, press  or  to select another line and use the numeric entry screen to enter limit values.
		Cal Due Alarm	<ul style="list-style-type: none"> • Cal Due Alarm On Off • Cal Due Limit 	Menu used to turn the calibration due alarm on or off and to set the calibration due alarm time. The calibration due alarm is triggered if a set amount of time has passed without a calibration being performed. Press  or  to change the setting on the top line, press  or  to select another line and use the numeric entry screen to enter the calibration due value in hours.
	Temperature	Manual Temp Value	Default value or last entered value	Menu used to set the temperature value that will be used for all measurements and calibrations. Use the numeric entry screen to enter the temperature.
		Temperature Unit	<ul style="list-style-type: none"> • Celsius • Fahrenheit 	Menu used to select the temperature units.
		Temperature Calibration	<ul style="list-style-type: none"> • ATC 	Menu allows the temperature measured by an ATC probe (separate or built in to an electrode), to be adjusted by the operator.
		Temperature Input	<ul style="list-style-type: none"> • ATC • Manual 	Menu used to select the source of the temperature measurement.

COND Channel Menu

The COND Channel setup menu is used to review and change parameters relating to conductivity, TDS, salinity and resistivity measurements and calibrations.

Main Setup Menu	2nd Level	3rd Level	Menu Options	Menu Description
COND Channel	Method	List of Methods		Menu allows the current meter settings to be saved as a new method, an existing method to be run on the meter, or an existing method to be viewed, edited, copied, deleted or printed.
	Mode and Settings	Measure Mode	<ul style="list-style-type: none"> • Conductivity • Salinity • TDS • Resistivity 	Menu used to select the displayed measurement mode.
		Read Type	<ul style="list-style-type: none"> • Auto • Continuous • Timed 	<p>Menu used to select how the meter will take measurements.</p> <p>Auto (AR) – Press  to take a measurement. When the measurement is stable, it is locked on the display until  is pressed again.</p> <p>Continuous – The measurement is constantly updated on the display and stabilizing or ready is shown to indicate the measurement stability.</p> <p>Timed – Measurements are taken at a set time interval. To enter the time interval, highlight • Timed press  to highlight the hours (HH), minutes (MM) or seconds (SS), press f3 (edit) and use the numeric entry screen to change the values.</p>
		Cell Type	<ul style="list-style-type: none"> • Standard • USP 	Menu used to set the type of conductivity cell used as standard or USP. Select standard for most conductivity cells or select USP for 2-electrode low level conductivity cells (013016MD).
		Cell K	Default value or last entered value	Menu used to enter the nominal cell constant (K) value of the conductivity cell. The nominal cell constant is used during automatic conductivity calibrations. The value will automatically update when a conductivity calibration is completed.
		TDS Factor (TDS mode)	Default value or last entered value	Menu used to enter TDS factor value. Use the numeric entry screen to set the value.
		Type (Salinity mode)	<ul style="list-style-type: none"> • Practical Salinity • Sea Water 	Menu used to set the type of salinity measurement as practical salinity or sea water.
		Ref Temp.	<ul style="list-style-type: none"> • 5 °C • 10 °C • 15 °C • 20 °C • 25 °C 	Menu used to set the reference temperature for all conductivity measurements. All displayed conductivity measurements are reported at the selected reference temperature.
		Temp. Comp.	<ul style="list-style-type: none"> • Off • Linear • nLFn • nLFu • EP 	Menu used to select the type of temperature compensation used for all conductivity measurements. The temperature compensation can be turned off or set to Linear, nLFn (non-linear ultra pure non-degassed water), nLFu (non-linear ultra pure degassed water) or EP (temperature compensation off and warning is displayed if conductivity values are outside EP requirements for ultra pure water).
		Temp. Coeff.	Default value or last entered value	Menu used to enter temperature coefficient value. Use the numeric entry screen to set the value.

COND Channel Menu (cont.)

Main Setup Menu	2nd Level	3rd Level	Menu Options	Menu Description
COND Channel (cont.)	Mode and Settings (cont.)	Stability	<ul style="list-style-type: none"> • Smart Stability • Fast • Medium • Slow 	Menu used to select how the stability of the displayed measurement values is indicated. Smart Stability automatically compensates for measurement conditions and optimizes the meter response time.
		Averaging	<ul style="list-style-type: none"> • Off • Automatic Smart 	Menu used to turn the averaging function on or off. Automatic Smart automatically compensates for measurement conditions and optimizes the meter response time.
		Limit Alarm	<ul style="list-style-type: none"> • Limit Alarm <ul style="list-style-type: none"> On Off • Alarm Settings <ul style="list-style-type: none"> Low High High/Low • High Limit • Low Limit 	Menu used to turn the limit alarm on or off and to set the limit alarm parameters. The limit alarm is triggered if the measurement goes above a high value and/or below a low value set by the operator. Press  or  to change the setting on each line, press  or  to select another line and use the numeric entry screen to enter limit values.
		Cal Due Alarm	<ul style="list-style-type: none"> • Cal Due Alarm <ul style="list-style-type: none"> On Off • Cal Due Limit 	Menu used to turn the calibration due alarm on or off and to set the calibration due alarm time. The calibration due alarm is triggered if a set amount of time has passed without a calibration being performed. Press  or  to change the setting on the top line, press  or  to select another line and use the numeric entry screen to enter the calibration due value in hours.
	Temperature	Manual Temp Value	Default value or last entered value	Menu used to set the temperature value that will be used for all measurements and calibrations. Use the numeric entry screen to enter the temperature.
		Temperature Unit	<ul style="list-style-type: none"> • Celsius • Fahrenheit 	Menu used to select the temperature units.
		Temperature Calibration	<ul style="list-style-type: none"> • ATC 	Menu allows the temperature measured by an ATC probe (separate or built in to an electrode), to be adjusted by the operator.
		Temperature Input	<ul style="list-style-type: none"> • ATC • Manual 	Menu used to select the source of the temperature measurement.

Settings Menu

The Settings setup menu is used to review and change parameters relating to the general operation of the meter.

Main Setup Menu	2nd Level	Menu Options	Menu Description
Settings	Export Data	<ul style="list-style-type: none"> • Printing <ul style="list-style-type: none"> • On • Off • Comm Setup <ul style="list-style-type: none"> • RS232 • USB • Data Format <ul style="list-style-type: none"> • Printer • PC (CSV) • Comm Config <ul style="list-style-type: none"> • 1200 • 2400 • 4800 • 9600 • 19200 • 38400 	Menu used to turn data exporting on or off, set the meter to be interfaced using the RS232 or USB port, set the exported data format for a printer (string of text) or PC (comma delimited text) and set the baud rate.
	Data Log	<ul style="list-style-type: none"> • Off • On 	Menu used to turn on or off the data log feature.
	Date / Time	<ul style="list-style-type: none"> • Date <ul style="list-style-type: none"> • DD/MM/YY • MM/DD/YY • Time <ul style="list-style-type: none"> • 12 Hour Clock • 24 Hour Clock 	Menu used to set the date format as day/month/year or month/day/year; enter the date values; set the time format as 12 hour or 24 hour clock; and enter the time values. Use the numeric entry screen to enter the values.
	Language	<ul style="list-style-type: none"> • English • Spanish • German • French • Italian • Chinese 	Menu used to set the language for all displayed meter prompts.
	Key Press Beep	<ul style="list-style-type: none"> • Off • On 	Menu used to turn on or off the beep sound made every time a meter key is pressed.
	Alarm Beep	<ul style="list-style-type: none"> • Off • On 	Menu used to turn on or off the beep sound made when an alarm value is reached.

Settings Menu (cont.)

Main Setup Menu	2nd Level	Menu Options	Menu Description
Settings (cont.)	Stirrer	<ul style="list-style-type: none"> • Speed 1 • Speed 2 • Speed 3 • Speed 4 • Speed 5 	Menu used to turn the stirrer probe on or off and to set the stirrer probe speed. <i>Star A215 meters only.</i>
	Contrast	<ul style="list-style-type: none"> • Level 1 • Level 2 • Level 3 • Level 4 • Level 5 • Level 6 	Menu used to set the display contrast.
	Auto Shut Off	<ul style="list-style-type: none"> • Off • On 	Menu used to turn on or off the meter automatic shutoff feature, which turns the meter off when no keys are pressed for 20 minutes.
	User ID	Default value or last entered value	Menu used to set the user ID. Use the alphanumeric entry screen to enter the user ID.
	Sample ID	<ul style="list-style-type: none"> • Off • Manual • Auto Incremental 	Menu used to turn the sample ID off or on. When sample ID is set to manual or auto incremental, enter the sample ID in the measurement mode by pressing f2 (sample ID) and using the alphanumeric entry screen.

View Log Menu

The View Log setup menu is used to access information stored in the data log and calibration log. Refer to the Data Storage and Retrieval chapter for detailed information on using this setup menu.

Diagnostics Menu

The Diagnostics setup menu is used to perform the meter self-test, reset the meter to the factory default settings and display meter information including serial number and software revision. Refer to the Customer Services chapter for detailed information on using this setup menu.

This page intentionally left blank.







Chapter 4 pH, RmV and ORP Calibration

The Orion Star A200 and Star A300 series pH meters can perform a one to five point pH calibration, one point relative mV calibration and one point ORP calibration. Step-by-step instructions and prompts are displayed on the meter to assist operators with the calibration menus. The meter can save up to 10 calibrations in the log and calibration data can be exported from the meter to a printer or computer.





pH Calibration

One to five pH buffers can be used for calibration. Always use fresh pH buffers and select buffers that bracket the sample pH and are one to four pH units apart. Prepare the pH electrode according to the instructions in the electrode use guide. Connect the pH electrode and any other electrodes to be used (stirrer probe, ATC probe, reference electrode) to the meter. Power on the meter and set the measurement mode to pH.

*Note: In most calibration screens, press **f1 (esc)** to return to the measurement mode without saving the calibration.*

1. In the measurement mode, press **f1 (cal)**. In dual channel measurement displays, press  or  to highlight **pH – Channel** and press **f2 (select)**.
2. Rinse the pH electrode and any other electrodes in use with distilled water, blot dry with a lint-free tissue and place into the pH buffer.
3. When the electrode and buffer are ready, press **f3 (start)**. If using a Star A215 benchtop meter and stirrer probe, the stirrer probe will automatically start stirring at the speed selected in the setup menu once **f3 (start)** is pressed and stop stirring once the reading stabilizes.
4. Wait for the pH value on the meter to stabilize and stop flashing and perform one of the following actions:
 - a. Press **f2 (accept)** to accept the displayed value.
 - b. Press **f3 (edit)** to access the numeric entry screen and edit the value.
 - i. Press , ,  or  to highlight a number, decimal point or negative sign; press **f3 (enter)** to select the highlighted item and repeat until the value at the measured temperature is shown above the numeric entry screen.
 - ii. Press **f2 (done)** to exit the numeric entry screen.
 - iii. Press **f2 (accept)** to accept the entered value.
5. Press **f2 (next)** to proceed to the next buffer and repeat steps 2 through 4 or press **f3 (cal done)** to save and end the calibration. If five buffers are used, the calibration will save and end once the fifth value is accepted.
 - a. If a one point calibration is performed, press **f2 (accept)** to accept the displayed slope value or press **f3 (edit)** to access the numeric entry screen, enter the slope value and press **f2 (accept)**.
6. The meter will display the calibration summary including the average slope and export the data to the calibration log. Press **f1 (meas)** to proceed to the measurement mode or press **f2 (print)** to proceed to the measurement mode and export the data to a printer or computer.







Calibration Editing

1. In the calibration summary display (pH calibration step 6), press **f3 (cal edit)** to edit the calibration points.
2. Press  or  to highlight the calibration point to be edited and press **f2 (select)**.
3. Press  or  to highlight *Remeasure*, *Edit* or *Delete* and press **f2 (select)**.
 - a. If *Remeasure* is selected, repeat pH calibration steps 2 through 4.
 - b. If *Edit* is selected, press **f3 (edit)** to access the numeric entry screen, enter the new value, press **f2 (done)** and then press **f2 (accept)**. Select another calibration point to edit or press **f1 (back)**.
 - c. If *Delete* is selected, the calibration point will be deleted. If deleting the calibration point changes the calibration to a one point calibration, enter the slope using the numeric entry screen.
4. The meter will display an updated calibration summary and export the data to the calibration log. Press **f1 (meas)** to proceed to the measurement mode, press **f2 (print)** to proceed to the measurement mode and export the data to a printer or computer or press **f3 (cal edit)** to edit another calibration point.

RmV Calibration

One standard can be used for a relative mV calibration. Always use fresh standard. Prepare the electrode according to the instructions in the electrode use guide. Connect the electrode and any other electrodes to be used (stirrer probe, ATC probe, reference electrode) to the meter. Power on the meter and set the measurement mode to RmV.

*Note: In most calibration screens, press **f1 (esc)** to return to the measurement mode without saving the calibration.*

1. In the measurement mode, press **f1 (cal)**. In dual channel measurement displays, press  or  to highlight *pH – Channel* and press **f2 (select)**.
2. Rinse the electrode and any other electrodes in use with distilled water, blot dry with a lint-free tissue and place into the standard.
3. When the electrode and standard are ready, press **f3 (start)**. If using a Star A215 benchtop meter and stirrer probe, the stirrer probe will automatically start stirring at the speed selected in the setup menu once **f3 (start)** is pressed and stop stirring once the reading stabilizes.
4. Wait for the mV value on the meter to stabilize, indicated by the flashing **stabilizing** or solid **ready** icon, and perform one of the following actions:
 - a. Press **f2 (accept)** to accept the mV value shown on the *Rel Value* line.
 - b. Press **f3 (edit)** to access the numeric entry screen and edit the mV value shown on the *Rel Value* line.
 - i. Press , ,  or  to highlight a number, decimal point or negative sign; press **f3 (enter)** to select the highlighted item and repeat until the value at the measured temperature is shown.
 - ii. Press **f2 (done)** to exit the numeric entry screen.
 - iii. Press **f2 (accept)** to accept the entered mV value.
5. The meter will display the calibration summary including the mV offset and export the data to the calibration log. Press **f1 (meas)** to proceed to the measurement mode or press **f2 (print)** to proceed to the measurement mode and export the data to a printer or computer.



ORP Calibration

The mV reading of an ORP standard is dependent on the ORP electrode reference system, reference material and filling solution as well as the ORP standard temperature. An ORP electrode can be automatically calibrated to read 420 mV relative to the Standard Hydrogen Electrode (E_H) at 25°C when the Orion ORP standard (Cat. No. 967901 or 967961), Orion ORP electrode (Cat. No. 9678BNWP, 9778BNWP, 9180BNMD or 9179BNMD) and Orion 4 M KCl filling solution (Cat. No. 900011) or 4 M KCl gel (in Cat. No. 9179BNMD) are used. The raw mV reading of an electrode with the same conditions is 220 mV at 25 °C.

The Thermo Scientific Orion ORP standard is nonhazardous, stable and will not change over time, so it is an ideal standard for any ORP measurement system. The Orion Star A200 and Star A300 series pH meters offer a simple, automatic calibration to the E_H value in the ORP mode when using Orion ORP electrodes and standard. Visit www.thermoscientific.com/water for ORP application notes that include a table of ORP standard values at different temperatures.

One standard can be used for ORP calibration. Always use fresh ORP standard. Prepare the ORP electrode according to the instructions in the electrode use guide. Connect the electrode and any other electrodes to be used (stirrer probe, ATC probe, reference electrode) to the meter. Power on the meter and set the measurement mode to ORP.

*Note: In most calibration screens, press **f1 (esc)** to return to the measurement mode without saving the calibration.*

1. In the measurement mode, press **f1 (cal)**. In dual channel measurement displays, press  or  to highlight *pH – Channel* and press **f2 (select)**.
2. Rinse the ORP electrode and any other electrodes in use with distilled water, blot dry with a lint-free tissue and place into the standard.
3. When the electrode and standard are ready, press **f3 (start)**. If using a Star A215 benchtop meter and stirrer probe, the stirrer probe will automatically start stirring at the speed selected in the setup menu once **f3 (start)** is pressed and stop stirring once the reading stabilizes.
4. Wait for the mV value on the meter to stabilize, indicated by the flashing **stabilizing** or solid **ready** icon, and press **f2 (accept)** once the value is stable.
5. The meter will display the calibration summary including the mV offset and export the data to the calibration log. Press **f1 (meas)** to proceed to the measurement mode or press **f2 (print)** to proceed to the measurement mode and export the data to a printer or computer.

This page intentionally left blank.







Chapter 5 Conductivity Calibration

Automatic and Direct Calibration





One to five conductivity standards can be used for calibration. Always use fresh standards and select standards that are near the sample conductivity. Prepare the conductivity cell according to the instructions in the conductivity cell use guide. Connect the conductivity cell and any other electrodes to be used to the meter. Power on the meter and set the measurement mode to conductivity.

Note: For an automatic calibration, the nominal cell constant of the conductivity cell must be entered in the setup menu before the calibration is performed and Thermo Scientific Orion 100 $\mu\text{S}/\text{cm}$, 1413 $\mu\text{S}/\text{cm}$ and/or 12.9 mS/cm conductivity standards must be used.







*Note: In most calibration screens, press **f1 (esc)** to return to the measurement mode without saving the calibration.*

1. In the measurement mode, press **f1 (cal)**. In dual channel measurement displays, press  or  to highlight **Conductivity – Channel** and press **f2 (select)**.
2. Rinse the conductivity cell and any other electrodes in use with distilled water, blot dry with a lint-free tissue and place into the standard.
3. When the conductivity cell and standard are ready, press **f3 (start)**. If using a Star A215 benchtop meter and stirrer probe, the stirrer probe will automatically start stirring at the speed selected in the setup menu once **f3 (start)** is pressed and stop stirring once the reading stabilizes.
4. Wait for the conductivity value on the meter to stabilize and stop flashing and perform one of the following actions:
 - a. Press **f2 (accept)** to accept the displayed conductivity value.
 - b. Press **f3 (edit)** to access the numeric entry screen and edit the conductivity standard value.
 - i. Press , ,  or  to highlight a number or decimal point, press **f3 (enter)** to select the highlighted item and repeat until the standard value at the measured temperature is shown.
 - ii. Press **f2 (done)** to exit the numeric entry screen.
 - iii. Press **f2 (accept)** to accept the entered conductivity value.
5. Press **f2 (next)** to proceed to the next standard and repeat steps 2 through 4 or press **f3 (cal done)** to save and end the calibration. If five standards are used, the calibration will save and end once the fifth conductivity standard value is accepted.
6. The meter will display the calibration summary including the average calculated cell constant and export the data to the calibration log. Press **f1 (meas)** to proceed to the measurement mode or press **f2 (print)** to proceed to the measurement mode and export the data to a printer or computer.

Calibration Editing

1. In the calibration summary display (conductivity calibration step 6), press **f3 (cal edit)** to edit the calibration points.
2. Press  or  to highlight the calibration point to be edited and press **f2 (select)**.
3. Press  or  to highlight *Remeasure*, *Edit* or *Delete* and press **f2 (select)**.
 - a. If *Remeasure* is selected, repeat conductivity calibration steps 2 through 4.
 - b. If *Edit* is selected, press **f3 (edit)** to access the numeric entry screen, enter the new value, press **f2 (done)** and then press **f2 (accept)**. Select another calibration point to edit or press **f1 (back)**.
 - c. If *Delete* is selected, the calibration point will be deleted.
4. The meter will display an updated calibration summary and export the data to the calibration log. Press **f1 (meas)** to proceed to the measurement mode, press **f2 (print)** to proceed to the measurement mode and export the data to a printer or computer or press **f3 (cal edit)** to edit another calibration point.















Manual Conductivity Calibration

1. In the measurement mode, press **f1 (cal)**. In dual channel measurement displays, press  or  to highlight *Conductivity – Channel* and press **f2 (select)**.
2. Rinse the conductivity cell and any other electrodes in use with distilled water, blot dry with a lint-free tissue and place into the standard.
3. When the conductivity cell and standard are ready, press **f2 (CellK)**.
4. Press **f3 (edit)** to access the numeric entry screen and enter the cell constant of the conductivity cell.
 - a. Press , ,  or  to highlight a number or decimal point, press **f3 (enter)** to select the highlighted item and repeat until the cell constant value is shown.
 - b. Press **f2 (done)** to exit the numeric entry screen.
5. The calculated conductivity of the standard, based on the entered cell constant value, will be shown on the display. Perform one of the following actions:
 - a. Press **f2 (accept)** to accept the cell constant value and save and end the calibration.
 - b. Press **f3 (edit)** to re-enter the cell constant value and repeat steps 4a and 4b.
6. The meter will automatically proceed to the measurement mode.

Chapter 6 Temperature Calibration

The meter ATC temperature display has a relative accuracy of ± 0.1 °C. ATC probes (both separate and those built into electrodes) have varying temperature accuracies, usually ± 0.5 °C to ± 2 °C. Use this function only if it is necessary to calibrate the temperature readings taken by the ATC probe. Since the temperature offset calculated during the calibration is applied to all future temperature measurements, recalibrate if a different ATC probe is used.

Temperature calibration is for the calibration of an ATC probe (separate or built in to a pH electrode, ORP electrode or conductivity cell). If manual temperature compensation is being used and the display shows MAN as the temperature source icon, set the manual temperature value using the Manual Temp Value menu. The temperature calibration menu is not accessible unless an ATC probe is connected to the meter.

1. In the measurement mode, press .
2. Press , ,  or  to highlight *pH Channel* or *COND Channel* and press **f3 (select)**.
3. Press  or  to highlight *Temperature* and press **f3 (select)**.
4. Press  or  to highlight *Temperature Calibration* and press **f3 (select)**.
5. Press  or  to highlight *ATC* to identify the ATC probe that will be calibrated and press **f3 (select)**.
6. Place the ATC probe and thermometers into a solution with a known, stable temperature. It is recommended that two NIST traceable thermometers be used to measure and verify the temperature of the solution.
7. Wait for the temperature readings of the ATC probe and thermometers to stabilize (usually two to five minutes).
8. Press **f3 (edit)** to access the numeric entry screen and edit the temperature value.
 - a. Press , ,  or  to highlight a number, decimal point or negative sign; press **f3 (enter)** to select the highlighted item and repeat until the temperature value read by the thermometers is shown on the display.
 - b. Press **f2 (done)** to exit the numeric entry screen.
9. The meter will display the entered temperature value on the *Reference Temp* line, the original temperature read by the ATC probe on the *ATC* line and the temperature offset value that will be applied to all future temperature readings on the *Offset* line. Press **f2 (accept)** to proceed with the displayed temperature data, save and end the calibration and export the data to the calibration log.
10. Press **f1 (meas)** to proceed to the measurement mode or press **f2 (print)** to proceed to the measurement mode and export the data to a printer or computer.



This page intentionally left blank.





Chapter 7 Measurement

The Orion Star A215 and Star A325 meters are capable of showing measurements simultaneously on the display. The first channel can be set to measure pH, mV, RmV (relative mV) or ORP. The second channel can be set to measure Cond (conductivity), TDS, Salinity or Res (resistivity).

The meter can be set to display one or both of these measurement channels, depending on the operator's needs. In the measurement mode, press **f3 (channel)** to scroll through a single measurement display of channel one or channel two, or a dual measurement display of channel one and two. To change the measurement mode of a channel, press **f3 (channel)** until the single measurement display of that channel is shown and then press  until the correct mode is shown.

Note: It is highly recommended that any unused channels not be shown on the meter display while taking measurements, since the meter waits for all displayed channels to stabilize before logging the measurement data.

Press  while taking a measurement in the continuous measurement mode to freeze the display and press  a second time to unfreeze the display and continue the measurement. Press  while taking a measurement to manually export the measurement to the data log, if the data log is enabled in the setup menu.















1. Rinse the pH electrode, conductivity cell and any other electrodes in use with distilled water, blot dry with a lint-free tissue and place into the sample.
2. *Star A215 meters only* – If the stirrer probe is in use and the meter is in continuous or timed mode, press  to turn on the stirrer probe. If the stirrer probe is in use and the meter is in AUTO-READ mode, the stirrer probe will start stirring when  is pressed and stop stirring when the reading stabilizes.
3. Start the measurement and wait for it to stabilize.
 - a. If the meter is in AUTO-READ mode (default setting), press  to start the measurement. When the **AR** icon stops flashing, record the applicable measurement parameters and temperature of the sample. Press  again to start a new measurement.
 - b. If the meter is in continuous mode, the meter will immediately start taking a measurement and update the display whenever the measurement changes. Wait for the display to show **ready** and record the applicable measurement parameters and temperature of the sample.
 - c. If the meter is in timed mode, the meter will log measurements at the preselected time interval, regardless of the measurement stability. The meter will update the display whenever the measurement changes, so the applicable measurement parameters and temperature of the sample can be recorded when the display shows **ready**.
4. *Star A215 meters only* – If the stirrer probe is in use and the meter is in continuous or timed mode, press  to turn off the stirrer probe.
5. Remove the electrodes from the sample, rinse with distilled water, blot dry and place into the next sample.
6. Repeat steps 2 through 5 for all samples.
7. When all samples have been measured, store the electrodes according to their user guides.

This page intentionally left blank.









Chapter 8 Methods

The Orion Star A215 and Star A325 meters can save up to ten methods per channel and the corresponding calibration data for each method, for the fast and easy recollection of different meter setup parameters. The default meter setting is that no method is used and the method number will be shown as M100 or M200 if no method is in use. The current meter settings can be saved in the setup menu. Existing methods can be selected from the methods list and run on the meter. Methods can be viewed, edited, copied to a new method or deleted.





















Saving the Current Meter Settings as a New Method

1. In the measurement mode, press .
2. Press , ,  or  to highlight *pH Channel* or *COND Channel* and press **f3 (select)**.
3. Press  or  to highlight *Method* and press **f3 (select)**.
4. The meter will display *Current Settings* and a list of methods. The list will show the sequential number of the methods (*M101*) and the date, time and mode of each method (*07/01/11 12:45 pH*) if methods have been previously created.
5. Press  or  to highlight *Current Settings* and press **f3 (save)**.
6. Press  or  to highlight a method number that the current settings will be saved as and press **f2 (accept)**.
7. The meter will prompt for a method specific password to be created. The password must be at least 3 characters long.
 - a. Press **f3 (edit)** to access the numeric entry screen.
 - b. Press , ,  or  to highlight a number, press **f3 (enter)** to select the highlighted number and repeat until the new password is shown.
 - c. Press **f2 (done)** to exit the numeric entry screen.
 - d. Press **f2 (accept)** to accept the entered password.
8. The meter will automatically proceed to the measurement mode.

Loading an Existing Method

1. In the measurement mode, press .
2. Press , ,  or  to highlight *pH Channel* or *COND Channel* and press **f3 (select)**.
3. Press  or  to highlight *Method* and press **f3 (select)**.
4. The meter will display *Current Settings* and a list of methods. The list will show the sequential number of the methods (*M101*) and the date, time and mode of each method (*07/01/11 12:45 pH*) if methods have been previously created.
5. Press  or  to highlight the method to be loaded and press **f2 (load)**.
6. The meter will automatically proceed to the measurement mode.

Editing, Copying or Deleting an Existing Method













1. In the measurement mode, press .
2. Press , ,  or  to highlight *pH Channel* or *COND Channel* and press **f3 (select)**.
3. Press  or  to highlight *Method* and press **f3 (select)**.
4. The meter will display *Current Settings* and a list of methods. The list will show the sequential number of the methods (*M101*) and the date, time and mode of each method (*07/01/11 12:45 pH*) if methods have been previously created.
5. Press  or  to highlight the desired method and press **f3 (options)**.
6. Enter the method specific password.
 - a. Press **f3 (edit)** to access the numeric entry screen.
 - b. Press , ,  or  to highlight a number, press **f3 (enter)** to select the highlighted number and repeat until the password is shown.
 - c. Press **f2 (done)** to exit the numeric entry screen.
 - d. Press **f2 (accept)** to accept the entered password.
7. Press  or  to highlight *Edit*, *Copy* or *Delete* and press **f2 (accept)**.
 - a. If *Edit* is selected – press  or  to highlight any setup menu parameters that need to be changed and press **f3 (select)**. Review and change all applicable setup menu parameters. Press **f1 (back)** to return to the list of methods and then press  to return to the measurement mode.
 - b. If *Copy* is selected – press  or  to highlight a method number that the selected method will be copied to and press **f2 (accept)**. The meter will automatically proceed to the measurement mode.
 - c. If *Delete* is selected – press **f2 (yes)** to delete the method or press **f3 (no)** to keep the method. The meter will automatically proceed to the measurement mode.

Chapter 9 Data Storage and Retrieval

























Data Storage Settings

The data and calibration storage settings include the measurement read type, computer and printer export settings and data log settings. The measurement read type determines when the meter sends measurements to the data log, if the data log is enabled in the setup menu, and to a printer or computer, if a printer or computer is connected to the meter and enabled in the setup menu. Review the date and time settings and update as needed.











Read Type Selection

1. In the measurement mode, press .
2. Press , ,  or  to highlight *pH Channel* or *COND Channel* and press **f3 (select)**.
3. Press  or  to highlight *Mode and Settings* and press **f3 (select)**.
4. Press  or  to highlight *Read Type* and press **f3 (select)**.
5. Press  or  to highlight *Auto*, *Continuous* or *Timed* and press **f3 (select)**.
 - a. If *Timed* is selected and the time interval needs to be changed – highlight *Timed*; press  to highlight hours (HH), minutes (MM) or seconds (SS); press **f3 (edit)** to access the numeric entry screen; use the numeric entry screen to change the values and press **f1 (back)** when the time interval is correct.
6. Press  to return to the measurement mode.

Computer and Printer Export Settings

1. In the measurement mode, press .
2. Press , ,  or  to highlight **Settings** and press **f3 (select)**.
3. Press  or  to highlight **Export Data** and press **f3 (select)**.
4. Press  or  to highlight **Printing** and press **f3 (select)**. Press  or  to highlight **On** or **Off** and press **f3 (select)**. Select **On** to allow data to be sent to a computer or printer.
5. Press  or  to highlight **Comm Setup** and press **f3 (select)**. Press  or  to highlight **RS232** or **USB** and press **f3 (select)**. Select **RS232** if the meter will be interfaced using the RS232 port and select **USB** if the meter will be interfaced using the USB port.
6. Press  or  to highlight **Data Format** and press **f3 (select)**. Press  or  to highlight **Printer** or **PC (CSV)** and press **f3 (select)**. Select **Printer** to export the data as a string of text and select **PC (CSV)** to export the data in comma delimited format.
7. Press  or  to highlight **Comm Config** and press **f3 (select)**. Press  or  to highlight **1200**, **2400**, **4800**, **9600**, **19200** or **38400** and press **f3 (select)**. Select the baud rate best for the data transfer requirements. The fixed meter output settings are 8 bits, 1 stop bit and parity none.
8. Press **f1 (back)** and then press  to return to the measurement mode.















Data Log Settings

1. In the measurement mode, press .
2. Press , ,  or  to highlight **Settings** and press **f3 (select)**.
3. Press  or  to highlight **Data Log** and press **f3 (select)**.
4. Press  or  to highlight **Off** or **On** and press **f3 (select)**.
5. Press **f1 (back)** and then press  to return to the measurement mode.













Viewing the Calibration Log and Data Log

The Orion Star A200 and Star A300 series meters save up to ten of the most recent calibrations per channel. The Star A215 meter saves up to 2000 sets of data points and the Star A325 meter saves up to 5000 sets of data points. A log number is assigned to each data point. The read type of the displayed channel or channels determines when measurements are exported to the data log. When a data point is exported to a computer or printer, the time stamp will include the hour, minutes and seconds.























Viewing the Calibration Log

1. In the measurement mode, press .
2. Press , ,  or  to highlight *View Log* and press **f3 (select)**.
3. Press  or  to highlight *Calibration Log* and press **f2 (accept)**.
4. Press  or  to highlight *pH – Channel* or *Conductivity – Channel* and press **f2 (select)**.
5. Press  or  to highlight *pH, RmV or ORP* (pH – Channel) or *Conductivity, Resistivity, TDS, or Salinity* (Conductivity – Channel) and press **f2 (select)**.
6. The meter will display a list of calibrations for the selected channel and calibration type. The list shows the sequential number of the calibration and the date and time it was saved (*07/01/2011 12:45*).
7. To view the calibration data, press  or  to highlight a specific calibration and press **f2 (select)**. Press **f2 (print)** to print the calibration, press **f3 (info)** to view the electrode slope between pH buffer points (pH – Channel only) or press **f1 (back)** to return to the list of calibrations.
8. Press  to return to the measurement mode.













Viewing the Data Log

1. In the measurement mode, press .
2. Press , ,  or  to highlight *View Log* and press **f3 (select)**.
3. Press  or  to highlight *Data Log* and press **f2 (accept)**.
4. Press  or  to highlight *pH – Channel* or *Conductivity – Channel* and press **f2 (select)**.
5. The meter will display a list of the data points. The list shows the sequential number of the data point and the date and time the data point was saved (*07/01/2011 12:45*).
6. To view the measurement information for an individual data point, press  or  to highlight the data point and press **f2 (select)**. Press **f2 (print)** to print the data point or press **f1 (back)** to return to the list of data points.
7. Press  to return to the measurement mode.

Exporting the Data Log to a Computer or Printer

1. In the measurement mode, press .
2. Press , ,  or  to highlight *View Log* and press **f3 (select)**.
3. Press  or  to highlight *Data Log* and press **f2 (accept)**.
4. Press  or  to highlight *pH – Channel* or *Conductivity – Channel* and press **f3 (select)**.
5. The meter will display a list of the data points. The list shows the sequential number of the data point and the date and time the data point was saved (*07/01/2011 12:45*).
6. Press **f3 (options)**.
7. Press  or  to highlight *Log Export* and press **f2 (accept)**.
8. Press  or  to highlight *Today, Last 10, Range* or *All* as the data log points to be exported and press **f2 (accept)**.
 - a. If *Today, Last 10* or *All* is selected – press **f2 (yes)** to export the data.
 - b. If *Range* is selected – enter the first and last date points:
 - i. Press **f3 (edit)** to display the numeric entry screen.
 - ii. Press , ,  or  to highlight a number, press **f3 (enter)** to select the highlighted number and repeat until the number of the first data point to be exported is shown on the display.
 - iii. Press **f2 (done)** to exit the numeric entry screen.
 - iv. Press  to enter the last data point.
 - v. Press **f3 (edit)** to display the numeric entry screen.
 - vi. Press , ,  or  to highlight a number, press **f3 (enter)** to select the highlighted number and repeat until the number of the last data point to be exported is shown on the display.
 - vii. Press **f2 (done)** to exit the numeric entry screen.
 - viii. Press **f2 (accept)** and then press **f2 (yes)** to export the data.
9. After exporting the data, the meter will automatically return to the measurement mode.

Clearing the Data Log

1. In the measurement mode, press .
2. Press , ,  or  to highlight *View Log* and press **f3 (select)**.
3. Press , or  to highlight *Data Log* and press **f2 (accept)**.
4. Press , or  to highlight *pH – Channel* or *Conductivity – Channel* and press **f3 (select)**.
5. The meter will display a list of the data points. The list shows the sequential number of the data point and the date and time the data point was saved (*07/01/2011 12:45*).
6. Press **f3 (options)**.
7. Press , or  to highlight *Log Clear* and press **f2 (accept)**.
8. Press **f2 (yes)** twice to clear the entire data log.
9. Enter the password. The default is **111111** and pressing **f2 (accept)** will advance the meter to the next step.
10. Press **f1 (back)** and then press  to return to the measurement mode.

Interfacing a Printer

The Orion Star printer, Cat. No. 1010006, is recommended for use with the Orion Star A200 and Star A300 series meters. The Orion Star printer has a 9600 baud rate and it is packaged with the RS232 printer cable, Cat. No. 250302-001, which is required to interface an Orion Star A meter to a printer. The baud rate of the Orion Star A200 and Star A300 series meters can be set to 1200, 2400, 4800, 9600, 19200 or 38400 for communication to different printers. The fixed meter settings are: number of bits = 8, stop bits = 1, parity = none. The flow control for the printer should be set to XON/XOFF. The meter will send measurements and calibration data to the printer if the printer option is turned on in the setup menu. Alternatively, measurements and calibration data can be sent to the data log and calibration log. From the data log and calibration log, the operator can choose to print a single data log point, a range of data log points or the entire data log.

Interfacing a Computer

The Orion Star A200 and Star A300 series meters can send measurements and calibration data to a computer in a comma delimited format that is easy to parse in computer programs like Excel. Connect the RS232 computer cable, Cat. No. 1010053, to the RS232 input on the meter and the RS232 input on a computer. The baud rate of the Orion Star A series meters can be set to 1200, 2400, 4800, 9600, 19200 or 38400. The fixed meter settings are: number of bits = 8, stop bits = 1, parity = none. The flow control for the computer should be set to XON/XOFF. The meter will send measurements and calibration data to the computer if the computer option is turned on in the setup menu. Alternatively, measurements and calibration data can be sent to the data log and calibration log. From the data log and calibration log, the operator can choose to send a single data log point, a range of data log points or the entire data log to the computer.

A complimentary copy of general data logging software is available for use with the Orion Star A200 and Star A300 series meters. This can be found on the CD included with the meter or at www.thermoscientific.com/water.









Chapter 10 Customer Services

Meter Errors and Recommended Actions

Error	Recommended Actions
Display Error	If this error occurs, contact Technical Support.
Hardware Error	If this error occurs, contact Technical Support.
Channel Input Error	Disconnect all of the electrodes from the meter, connect the BNC shorting cap to the BNC inputs and repeat the self test.
Reference Input Error	Make sure that all of the electrodes are disconnected from the meter (including the reference input), connect the BNC shorting cap to the BNC input and repeat the self test.
Ground Input Error	Make sure that all of the electrodes are disconnected from the meter (including the ground input), connect the BNC shorting cap to the BNC input and repeat the self test.
Keypad Failure	Repeat the self test. When the meter prompts, press each of the keys one at a time, including the power key, within five seconds of one other. If the error persists, contact Technical Support.
Over Range Measurement or Under Range Measurement	If the measurement is flashing 9999 and over range or under range, the measurement value is outside of the allowable measurement range. Make sure that the electrode is connected to the appropriate meter input and the electrode parameters are entered correctly in the setup menu. Clean the electrode according to the electrode user guide and re-calibrate the electrode with new buffers or standards. If the error persists, perform the meter self test.
Measurement Out of Range	Make sure that the electrode is connected to the appropriate meter input and the electrode parameters are entered correctly in the setup menu. Clean the electrode according to the electrode user guide and re-calibrate the electrode with new buffers or standards. Perform the meter self test.

Meter Self Test and Checkout

Meter Self Test

1. In the measurement mode, press setup .
2. Press , ,  or  to highlight *Diagnostics* and press **f3 (select)**.
3. Press  or  to highlight *Self Test* and press **f2 (accept)**.
4. Disconnect all of the electrodes and probes from the meter, attach the BNC shorting cap to the BNC input and press **f2 (yes)**.
5. Press **f2 (yes)** to start the self test.
6. The meter will perform an accuracy test. When the meter displays *Accuracy Test Passed*, press **f2 (next)**.
7. The meter will perform an EPROM test. When the meter displays *E2Prom Test Passed*, press **f2 (next)**.
8. The meter will perform a keypad test. Press each of the keys on the keypad (including ) one at a time in any order. When the meter displays *Keypad Test Passed*, press **f2 (next)**.
9. The meter will display *Self Test Passed*. Press  to return to the measurement mode.

Meter Checkout (pH)

1. After the self test is complete, the meter will return to the measurement mode. Keep all of the electrodes disconnected from the meter and keep the BNC shorting cap attached to the BNC input on the meter.
2. Set the measurement mode to pH. The meter should read a steady $7.000 \text{ pH} \pm 0.002 \text{ pH}$. If the meter does not read a steady 7.000 ± 0.002 , perform a one point pH calibration with the BNC shorting cap attached to the BNC input. Set the pH value to 7.000 and the slope value to 100.0. Refer to the pH Calibration section for detailed instructions.
3. In the measurement mode, the meter should read a steady $0.0 \text{ mV} \pm 0.2 \text{ mV}$. If the meter does not read a steady $0.0 \text{ mV} \pm 0.2 \text{ mV}$ with the BNC shorting cap attached to the BNC input, contact Technical Support.











Meter Checkout (Conductivity)

Note: Requires the conductivity calibration resistor kit for Orion Star A series conductivity meters, Cat. No. 1010001, which must be purchased separately.

The conductivity calibration kit contains six resistors that simulate standard conductance values on a meter. The resistors may be used to verify proper meter function by comparing the meter reading to the conductance of the resistor. The conductivity calibration kit verifies proper meter function only. After the meter function is verified, the conductivity cell must be calibrated. Calibrate the cell constant of the conductivity cell according to the meter and cell user guides. Each resistor is labeled alphabetically. The actual resistance and conductance values are printed on each resistor. The nominal resistance and conductance values are listed on the label of the calibration kit box for reference.







1. Remove the conductivity cell and all other electrodes from the meter.
2. Perform a manual conductivity calibration on the meter and set the cell constant to 1.000 cm^{-1} .
3. Set the temperature value to $25.0 \text{ }^\circ\text{C}$ and turn the temperature compensation off.
4. Attach a resistor to the meter by aligning the tabs on the resistor and meter.
5. Push the resistor in until it is firmly in place. If the alignment is incorrect, the resistor and/or meter input can be damaged.
6. When the meter indicates a stable conductivity value, compare the displayed value to the actual conductance of the resistor. The displayed conductivity value for each resistor should fall within the accuracy specification of the meter plus $\pm 0.5\%$ of the actual resistor conductance. Since the resistor kits are made to test the accuracy of the meter, it is important that each displayed resistor value falls within the meter accuracy specification.

Electrode Stability Test

1. In the measurement mode, press .
2. Press , ,  or  to highlight *Diagnostics* and press **f3 (select)**.
3. Press  or  to highlight *Stability Test* and press **f2 (accept)**.
4. Press  or  to highlight *pH – Channel* or *Conductivity – Channel* and press **f2 (next)**.
5. Make sure the electrode or probe to be tested is connected to the channel selected in the previous step and press **f2 (yes)**.
6. Place the electrode or probe in an appropriate solution with a stable temperature and press **f2 (yes)**.
 - a. Orion pH 7 buffer (Cat. No. 910107, 910760 or 910710) is recommended for testing a pH electrode.
 - b. Orion ORP standard (Cat. No. 967901 or 967961) is recommended for testing an ORP electrode.
 - c. Orion 1413 μ S/cm conductivity standard (Cat. No. 011007 or 01100710) is recommended for testing most conductivity cells. Orion 100 μ S/cm conductivity standard (Cat. No. 011008) is recommended for testing low range conductivity cells.
7. The meter will perform the stability test and show the mV per minute or μ S/cm per minute drift and noise on the display.
8. The meter will display *Stability Test Passed* or *Stability Test Failed*. Press **f1 (esc)** or  to return to the measurement mode.







Meter Factory Reset

After a factory reset is performed, all of the meter settings will be reset to the factory defaults and the data log, calibration log and methods will be deleted.









1. In the measurement mode, press .
2. Press , ,  or  to highlight *Diagnostics* and press **f3 (select)**.
3. Press  or  to highlight *Factory Reset* and press **f2 (accept)**.
4. Press **f2 (yes)** to reset the meter.
5. The meter will pause, power off and restart with the factory default settings.

Meter User Reset

After a user reset is performed, all of the meter setup menu settings will be reset to the defaults; however, the data log, calibration log and methods will be retained.

1. In the measurement mode, press .
2. Press , ,  or  to highlight *Diagnostics* and press **f3 (select)**.
3. Press  or  to highlight *User Reset* and press **f2 (accept)**.
4. Press **f2 (yes)** to reset the meter.
5. The meter will pause and then return to the measurement mode with the default setup menu settings.

About Meter

1. In the measurement mode, press .
2. Press , ,  or  to highlight *Diagnostics* and press **f3 (select)**.
3. Press  or  to highlight *About Meter* and press **f2 (accept)**.
4. The meter model, measurement parameters, serial number and software revision will be displayed.
5. Press **f1 (back)** to return to the diagnostics menu or press  to return to the measurement mode.

Assistance

After troubleshooting all components of your measurement system, contact Technical Support. Within the United States call 1.800.225.1480 and outside the United States call 978.232.6000 or fax 978.232.6031. In Europe, the Middle East and Africa, contact your local authorized dealer. For the most current contact information, visit www.thermoscientific.com/water.

Warranty and Registration

To register your meter and for the most current warranty information, visit www.thermoscientific.com/water.

Ordering Information

Orion Star A200 Series Benchtop Meters	
Cat. No.	Description
STARA2110	Star A211 pH Benchtop Meter with Electrode Stand
STARA2115	Star A211 pH Benchtop Meter with Electrode Stand; 8302BNUMD ROSS pH/ATC Triode; 810199 ROSS pH Buffer Kit
STARA2120	Star A212 Conductivity Benchtop Meter with Electrode Stand
STARA2125	Star A212 Conductivity Benchtop Meter with Electrode Stand; 013005MD Conductivity Cell; 011007 Conductivity 1413 μ S/cm Standard
STARA2126	Star A212 Conductivity Benchtop Meter with Electrode Stand; 013016MD Conductivity Cell with Detachable Flow Through Cell; 011008 Conductivity 100 μ S/cm Standard
STARA2130	Star A213 RDO/DO Benchtop Meter with Electrode Stand
STARA2135	Star A213 RDO/DO Benchtop Meter with Electrode Stand; 083005MD Polarographic DO Probe with Calibration Sleeve; 080513 Probe Maintenance Kit; BOD Funnel, Stirrer and Adapter
STARA2136	Star A213 RDO/DO Benchtop Meter with Electrode Stand; 086030MD AUTO-STIR DO/BOD Probe; 080514 Polarographic Electrolyte Solution; 080513 Probe Maintenance Kit
STARA2140	Star A214 pH/ISE Benchtop Meter with Electrode Stand
STARA2145	Star A214 pH/ISE Benchtop Meter with Electrode Stand; 8102BNUWP ROSS Ultra pH Electrode; 927007MD ATC Probe; 096019 Stirrer Probe; 810199 ROSS pH Buffer Kit
STARA2146	Star A214 pH/ISE Benchtop Meter with Electrode Stand; 8102BNUWP ROSS Ultra pH Electrode; 927007MD ATC Probe; 9512HPBNWP High-Performance Ammonia Electrode; 096019 Stirrer Probe; 951007 Ammonia 1000ppm Standard; 951210 Low-level Ammonia ISA; 951213 Ammonia Electrode Storage Solution
STARA2147	Star A214 pH/ISE Benchtop Meter with Electrode Stand; 8102BNUWP ROSS Ultra pH Electrode; 927007MD ATC Probe; 9609BNWP Fluoride Electrode; 096019 Stirrer Probe; 040906 Fluoride 1ppm with TISAB II Standard; 040907 Fluoride 2ppm with TISAB II Standard; 040908 Fluoride 10ppm with TISAB II Standard; 940909 TISAB II
STARA2148	Star A214 pH/ISE Benchtop Meter with Electrode Stand; 8102BNUWP ROSS Ultra pH Electrode; 927007MD ATC Probe; 8611BNWP ROSS Sodium Electrode with Sodium Standards, Reagents and Solutions; 096019 Stirrer Probe
STARA2150	Star A215 pH/Conductivity Benchtop Meter with Electrode Stand
STARA2155	Star A215 pH/Conductivity Benchtop Meter with Electrode Stand; 8157BNUMD ROSS pH/ATC Triode; 013005MD Conductivity Cell; 810199 ROSS pH Buffer Kit; 011007 Conductivity 1413 μ S/cm Standard
STARA2160	Star A216 pH/RDO/DO Benchtop Meter with Electrode Stand
STARA2165	Star A216 pH/RDO/DO Benchtop Meter with Electrode Stand; 8157BNUMD ROSS pH/ATC Triode; 083005MD Polarographic DO Probe with Calibration Sleeve; 810199 ROSS pH Buffer Kit; 080513 Probe Maintenance Kit; BOD Funnel, Stirrer and Adapter

Ordering Information (cont.)

Orion Star A200 and Star A300 Series Portable Meters	
Cat. No.	Description
STARA2210	Star A221 pH Portable Meter
STARA2215	Star A221 pH Portable Meter; 8107UWMMD ROSS pH/ATC Triode with 3 Meter Cable; 910410 pH 4.01 Buffer Pouches; 910710 pH 7.00 Buffer Pouches; 911010 pH 10.01 Buffer Pouches; 810001 ROSS Electrode Storage Solution; 911110 Rinse Solution Pouches; STARA-CS Star A Carrying Case; STARA-AR Star A Meter Armor
STARA2220	Star A222 Conductivity Portable Meter
STARA2225	Star A222 Conductivity Portable Meter; 013010MD Conductivity Cell with 3 Meter Cable; 01100710 Conductivity 1413µS/cm Standard Pouches; 911110 Rinse Solution Pouches; STARA-CS Star A Carrying Case; STARA-AR Star A Meter Armor
STARA2230	Star A223 RDO/DO Portable Meter
STARA2235	Star A223 RDO/DO Portable Meter; 087010MD RDO Optical DO Probe with 3 Meter Cable; STARA-CS Star A Carrying Case; STARA-AR Star A Meter Armor
STARA3210	Star A321 pH Portable Meter
STARA3215	Star A321 pH Portable Meter; 8107UWMMD ROSS pH/ATC Triode with 3 Meter Cable; 910410 pH 4.01 Buffer Pouches; 910710 pH 7.00 Buffer Pouches; 911010 pH 10.01 Buffer Pouches; 810001 ROSS Electrode Storage Solution; 911110 Rinse Solution Pouches; STARA-CS Star A Carrying Case; STARA-AR Star A Meter Armor
STARA3220	Star A322 Conductivity Portable Meter
STARA3225	Star A322 Conductivity Portable Meter; 013010MD Conductivity Cell with 3 Meter Cable; 01100710 Conductivity 1413µS/cm Standard Pouches; 911110 Rinse Solution Pouches; STARA-CS Star A Carrying Case; STARA-AR Star A Meter Armor
STARA3230	Star A323 RDO/DO Portable Meter
STARA3235	Star A323 RDO/DO Portable Meter; 087010MD RDO Optical DO Probe with 3 Meter Cable; STARA-CS Star A Carrying Case; STARA-AR Star A Meter Armor
STARA3240	Star A324 pH/ISE Portable Meter
STARA3245	Star A324 pH/ISE Portable Meter; 8107UWMMD ROSS pH/ATC Triode with 3 Meter Cable; 910410 pH 4.01 Buffer Pouches; 910710 pH 7.00 Buffer Pouches; 911010 pH 10.01 Buffer Pouches; 810001 ROSS Electrode Storage Solution; 911110 Rinse Solution Pouches; STARA-CS Star A Carrying Case; STARA-AR Star A Meter Armor
STARA3250	Star A325 pH/Conductivity Portable Meter
STARA3255	Star A325 pH/Conductivity Portable Meter; 8107UWMMD ROSS pH/ATC Triode with 3 Meter Cable; 013010MD Conductivity Cell with 3 Meter Cable; 910410 pH 4.01 Buffer Pouches; 910710 pH 7.00 Buffer Pouches; 911010 pH 10.01 Buffer Pouches; 810001 ROSS Electrode Storage Solution; 01100710 Conductivity 1413µS/cm Standard Pouches; 911110 Rinse Solution Pouches; STARA-CS Star A Carrying Case; STARA-AR Star A Meter Armor
STARA3260	Star A326 pH/RDO/DO Portable Meter
STARA3265	Star A326 pH/RDO/DO Portable Meter; 8107UWMMD ROSS pH/ATC Triode with 3 Meter Cable; 087010MD RDO Optical DO Probe with 3 Meter Cable; 910410 pH 4.01 Buffer Pouches; 910710 pH 7.00 Buffer Pouches; 911010 pH 10.01 Buffer Pouches; 810001 ROSS Electrode Storage Solution; STARA-CS Star A Carrying Case; STARA-AR Star A Meter Armor
STARA3290	Star A329 pH/ISE/Conductivity/RDO/DO Portable Meter
STARA3295	Star A329 pH/ISE/Conductivity/RDO/DO Portable Meter; 8107UWMMD ROSS pH/ATC Triode with 3 Meter Cable; 013010MD Conductivity Cell with 3 Meter Cable; 087010MD RDO Optical DO Probe with 3 Meter Cable; 910410 pH 4.01 Buffer Pouches; 910710 pH 7.00 Buffer Pouches; 911010 pH 10.01 Buffer Pouches; 810001 ROSS Electrode Storage Solution; 01100710 Conductivity 1413µS/cm Standard Pouches; 911110 Rinse Solution Pouches; STARA-CS Star A Carrying Case; STARA-AR Star A Meter Armor

Ordering Information (cont.)

Orion Star A Series Accessories and Electrodes	
Cat. No.	Description
STARA-BEA	Orion Star A Series Electrode Arm and Holder (Attaches to base of meter or STARA-HB base)
STARA-HB	Orion Star A Series Electrode Stand Base Only (Use when electrode arm is not attached to meter)
STARA-CS	Orion Star A Series Portable Hard Carrying Case
STARA-AR	Orion Star A Series Portable Meter Armor with Stand, includes one pH Electrode Holder with Storage Sleeve and one Conductivity Cell and DO Probe Holder
STARA-ESPH	Orion Star A Series pH Electrode Holder for Meter Armor (requires pH storage sleeve, purchase separately)
STARA-ESCD	Orion Star A Series Conductivity Cell and DO Probe Holder for Meter Armor
1010003	Orion Star A Series Power Adapter for Benchtop and Portable Meters
8102BNUWP	ROSS Ultra Glass Refillable pH Electrode
8302BNUMD	ROSS Glass Refillable pH/ATC Triode
8157BNUMD	ROSS Refillable Epoxy pH/ATC Triode
8107UWMMD	ROSS Gel-filled Epoxy pH/ATC Triode with 3 Meter Cable
927005MD	Epoxy Steel ATC Probe
927007MD	Stainless Steel ATC Probe
9179BNMD	Gel-filled Epoxy ORP/ATC Triode
9180BNMD	Refillable Epoxy ORP/ATC Triode
9512HPBNWP	High-Performance Ammonia Electrode
9609BNWP	Fluoride Electrode
8611BNWP	ROSS Sodium Electrode with Sodium Standards, Reagents and Solutions
013005MD	DuraProbe Epoxy 4-Cell (K=0.475) Conductivity Cell
013010MD	DuraProbe Epoxy 4-Cell (K=0.475) Conductivity Cell with 3 Meter Cable
013020MD	DuraProbe Epoxy 4-Cell (K=0.475) Conductivity Cell with 6 Meter Cable
013025MD	DuraProbe Epoxy 4-Cell (K=0.475) Conductivity Cell with 10 Meter Cable
013016MD	Steel 2-Cell (K=0.1) Conductivity Cell with Detachable Flow Through Cell
083005MD	Polarographic DO Probe with Calibration Sleeve
083010MD	Polarographic DO Probe with Calibration Sleeve and 3 Meter Cable
083025MD	Polarographic DO Probe with Calibration Sleeve and 10 Meter Cable
086030MD	AUTO-STIR DO/BOD Probe
087010MD	RDO Optical DO Probe with 3 Meter Cable
087020MD	RDO Optical DO Probe with 6 Meter Cable
087030MD	RDO Optical DO Probe with 10 Meter Cable
096019	Stirrer Probe for Star A200 Series Benchtop Meters

Chapter 11 Meter Compliance

Notice of Compliance

This equipment generates, uses, and can radiate radio frequency energy and if not installed and used in accordance with the instruction manual, may cause interference to radio communications. It has been tested and found to comply with the limits for a Class A computing device pursuant to Subpart J of Part 15 of FCC Rules, which are designed to provide reasonable protection against such interference when operated in a commercial environment. Operation of this equipment in a residential area is likely to cause interference in which case the user, at his own expense, will be required to take whatever measures may be required to correct the interference.

“This digital apparatus does not exceed the (Class A) limits for radio noise emissions from digital apparatus set out in the Radio Interference Regulations of the Canadian Department of Communications.”

“Le present appareil numerique n’emet pas de bruits radioelectriques depassant les limites applicables aux appareils numeriques (de la class A) prescrites dans le Reglement sur le brouillage radioelectrique edicte par le ministere des Communications du Canada.”

WEEE Compliance



This product is required to comply with the European Union’s Waste Electrical & Electronic Equipment (WEEE) Directive 2002/96/EC. It is marked with the symbol on the left.

Thermo Fisher Scientific has contracted with one or more recycling/disposal companies in each EU Member State and this product should be disposed of or recycled through them. Further information on compliance with these directives, the recyclers in your country, and information on Thermo Scientific Orion products that may assist the detection of substances subject to the RoHS Directive are available at www.thermoscientific.com.

Declaration of Conformity

Manufacturer: Thermo Fisher Scientific Inc.

Address: Ayer Rajah Crescent
Blk 55 #04-16/24
Singapore 139949
Singapore

Hereby declares that the following products:

Benchtop meters are rated 100 to 240 VAC, 50/60 Hz, 0.5A.
Handheld meters use four non-rechargeable AA batteries.

Benchtop Meters

Orion Star A211 pH
Orion Star A212 Conductivity
Orion Star A213 RDO/DO
Orion Star A214 pH/ISE
Orion Star A215 pH/Conductivity
Orion Star A216 pH/RDO/DO

Portable Meters

Orion Star A221 pH
Orion Star A222 Conductivity
Orion Star A223 RDO/DO
Orion Star A321 pH
Orion Star A322 Conductivity
Orion Star A323 RDO/DO
Orion Star A324 pH/ISE
Orion Star A325 pH/Conductivity
Orion Star A326 pH/RDO/DO
Orion Star A329 pH/ISE/Conductivity/RDO/DO

Equipment Class:

Measurement, control and laboratory
Orion Star A-series meters are EMC Class A

Conforms with the following directives and standards:

EN61326-1:2006

Electromagnetic Compatibility (EMC Directive)

Electrical equipment for measurement,
control and laboratory use - EMC requirements

EN61010-1:2001

Safety Standards

UL61010-1:2004

Safety requirements for electrical equipment for measurement,
control and laboratory use - general requirements

CAN/CSA C22.2 No. 61010-1-04



Cheow Kwang Chan
QA/Regulatory Manager

Place and Date of Issue:
June 15, 2011
Singapore

Meter Specifications

Meter Operating Conditions	
Operating Ambient Temperature	5 to 45 °C
Operating Relative Humidity	5 to 85 %, non-condensing
Storage Temperature	-20 to +60 °C
Storage Relative Humidity	5 to 85 %, non-condensing
Pollution	Degree 2
Overvoltage	Category II
Weight	Portable: 450g Benchtop: 850g
Size	Portable: 5.9cm (H) x 10.5cm (W) x 23.1cm (D) Benchtop: 9.3cm (H) x 18.0cm (W) x 23.6cm (D)
Regulatory and Safety	CE, TUV 3-1, FCC Class A
Power Rating	DC Input: 9 VDC 1A Battery: 4 x AA
Shock and Vibration	Vibration: shipping/handling per ISTA #1A. Shock: drop test in packaging per ISTA #1A
Enclosure (designed to meet)	Portable: IP67 Benchtop: IP54
Warranty	3 year meter replacement

Universal Power Adapter Operating Conditions	
Operating Ambient Temperature	0 to 50 °C
Operating Relative Humidity	0 to 90 %, non-condensing
Storage Temperature	-20 to +75 °C
Storage Relative Humidity	0 to 90 %, non-condensing
Pollution	Degree 2
Overvoltage	Category II

Meter Parameter Specifications	
pH	
Range	-2.000 to 20.000
Resolution	0.1, 0.01, 0.001
Relative Accuracy	± 0.002
Calibration Points	Up to 5
Calibration Editing	Yes
mV/RmV	
Range	± 2000.0 mV
Resolution	0.1, 1
Relative Accuracy	±2%
E _H ORP Mode	Yes
Conductivity	
Range	0.00 to 3000 mS
Resolution	0.01 µS minimum; 4 significant figures minimum
Relative Accuracy	0.5% ± 1 digit
Reference Temperature	5, 10, 15, 20, 25 °C (default)
Temperature Compensation	Linear (0 to 10.0%/°C), nLFn, nLFu, EP
Compatible Cell Constants	0.001 to 199.9
Number of Calibration Points	Up to 5 points
Calibration Editing	Yes
Resistivity	
Range	2 ohm to 100 mega-ohm
Resolution	2 ohms-cm
Relative Accuracy	0.5% ± 1 digit
Salinity	
Type	Practical salinity or natural sea water
Range	0.01 to 80.0 ppt NaCl equivalent; 0.01 to 42 ppt practical salinity
Resolution	0.01
Relative Accuracy	± 0.1

TDS	
Range	0 to 200 ppt
Resolution	4 significant digits
Relative Accuracy	± 0.5% reading ± 1 digit
TDS Factor Range	Linear 0.01 to 10.00, default 0.49
Temperature Measurement	
Range	0 to 50°C
Resolution	0.1
Relative Accuracy	± 0.1
Offset Calibration	1 point
Data Logging	
Number of Points	Star A215: 2000 with time and date stamp Star A325: 5000 with time and date stamp
Log Function	Manual, Ready (AUTO-READ), Timed
Log Edit	Delete individual points, group of points or all
Inputs	
pH Electrode	BNC, reference pin
Conductivity with Built-in Temperature Probe or ATC Probe	8-pin MiniDIN
DO with Built-in Temperature Probe	9-pin MiniDIN
Output	
	RS232, USB
Power	
AC Adapter	Universal, 110 - 240 VAC (included with Star A215)
Battery Power	Four Alkaline AA (included with Star A325)
Battery Life	2000 hours

This page intentionally left blank.

Appendix 1 Advanced Meters Features

Automatic pH Buffer Recognition Feature

The Orion Star A200 and Star A300 series pH meters are capable of automatically recognizing pH 1.68, 4.01, 7.00, 10.01 and 12.46 buffers or pH 1.68, 4.01, 6.86, and 9.18 buffers during a pH calibration, depending on the pH buffer set that is selected in the setup menu. During a calibration, the meter uses the selected buffer set and the raw mV reading of the pH electrode in the buffer to recognize and display the buffer value at the measured temperature. The raw mV reading of the pH electrode in the buffer must be about ± 30 mV from the theoretical mV reading of the buffer in order for the meter to automatically recognize the buffer.

USA pH Buffer Set		DIN pH Buffer Set	
Buffer	mV Range	Buffer	mV Range
1.68	+285 to +345 mV	1.68	+285 to +345 mV
4.01	+207 to +147 mV	4.01	+207 to +147 mV
7.00	-30 to +30 mV	6.86	+38 to -22 mV
10.01	-207 to -147 mV	9.18	-99 to -159 mV
12.46	-293 to -353 mV		



Testing a pH Electrode for Automatic Buffer Recognition

To verify that the raw mV reading of the pH electrode in use is ± 30 mV from the theoretical mV reading of the buffer, and therefore verify that the pH electrode in use is capable of performing automatic buffer recognition, perform the following procedure.

1. Set the measurement mode to mV. Prepare the pH electrode according to the instructions in the pH electrode user guide.
2. Rinse the pH electrode with distilled water, blot it dry with a lint-free tissue and place the pH electrode into a pH 4.01 buffer at approximately 25 °C.
3. Wait for the measurement to stabilize and record the mV value of the pH 4.01 buffer when the meter indicates that the measurement is stable. The read type selected in the setup menu will determine how the mV measurements are displayed by the meter.
4. Remove the pH electrode from the pH 4.01 buffer.
5. Rinse the pH electrode with distilled water, blot it dry with a lint-free tissue and place the pH electrode into a pH 7.00 buffer at approximately 25 °C.
6. Wait for the measurement to stabilize and record the mV value of the pH 7.00 buffer when the meter indicates that the measurement is stable.
7. The mV reading of the pH electrode in pH 4.01 buffer should be in the range of +207 to +147 mV and the mV reading of the pH electrode in pH 7.00 buffer should be in the range of -30 to +30 mV. If the mV readings of the pH electrode are in the correct ranges, the pH electrode is capable of performing automatic buffer recognition. If the mV readings of the pH electrode are not in the correct ranges, the values of the pH buffers will need to be manually entered during a pH calibration.

Electrode Condition Icon

The electrode condition icon indicates the performance of the pH electrode, based on the last saved calibration and electrode measurement stability.

Icon	pH Electrode Definition of Icon
	Electrode condition is good and the electrode slope is 90 to 110 %.
	Electrode condition is fair and the electrode slope is 80 to 120 %.
	Electrode condition is bad and the electrode slope is less than 80 % or greater than 120 %. Consult the electrode user guide for instructions on how to clean, condition and troubleshoot the electrode.

Multipoint Calibration Curve Feature

The Orion Star A200 and Star A300 series pH meters utilize a point-to-point scheme for multipoint calibrations in the pH mode. In this technique, straight line segments are drawn between each successive pair of calibration points. Separate slope and E_o values are calculated using the adjacent pair of data points. For example, in a five point calibration, four slopes and five E_o values are calculated to correspond to the four line segments that connect the data. pH values for samples are calculated according to the segment that their potential values fall into. Those above or below the range of calibration are calculated by extrapolation from the top or bottom most segment.

The displayed slope is an average slope of the separate segments. The slope may be outside the range normally expected for an electrode. For example, if the slope of one segment is low, then the average will be lower than theoretical, even though the response may be Nernstian over most of the range.

The figure below is an example of a typical calibration curve using this method.

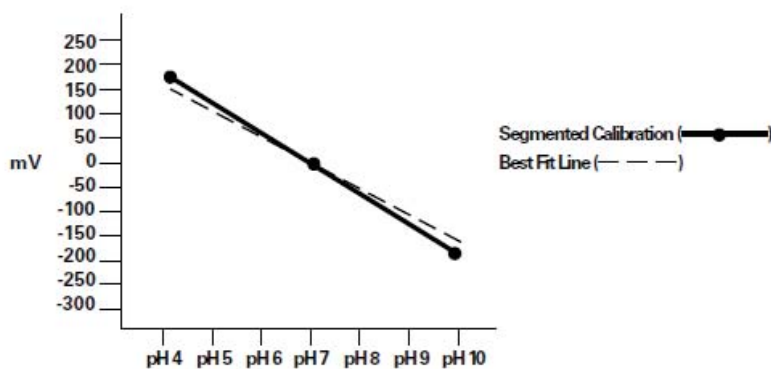

Conductivity Temperature Compensation and Reference Temperature

The Orion Star A200 and Star A300 series conductivity meters have the ability to use a temperature compensation feature that calculates and displays the conductivity measurements at a reference temperature of 5 °C, 10 °C, 15 °C, 20 °C or 25 °C. The temperature compensation can be turned off or set to Linear, nLFn (non-linear natural non-degassed water), nLFu (non-linear ultra pure degassed water) or EP (temperature compensation off and warning is displayed if conductivity values are outside EP requirements for ultra pure water). The closer the sample temperature is to the selected reference temperature, the more accurate the conductivity measurement will be, especially if the temperature compensation coefficient is estimated or inaccurate. The conductivity of a solution with a specific electrolyte concentration changes with temperature and this relationship is described by the temperature coefficient of the solution. The meter has a default temperature coefficient of 2.1 percent change in conductivity per °C, which is representative of many aqueous samples.

Solution (25 °C to 50 °C)	Temperature Coefficient (% / °C)
Ultra Pure Water	4.55
Salt (NaCl)	2.12
5% NaOH	1.72
Dilute Ammonia	1.88
10% HCl	1.32
5% Sulfuric Acid	0.96
98% Sulfuric Acid	2.84
Sugar Syrup	5.64

Conductivity and Total Dissolved Solids (TDS)

The Orion Star A200 and Star A300 series conductivity meters measure TDS as the total amount of dissolved inorganics in a solution. The dissolved inorganics carry a current that is measured by the conductivity probe. Since there is a direct relationship between conductivity and TDS, conductivity readings are used to estimate the presence of inorganics. The user must enter a TDS factor between 0.01 and 10 mg/L in the setup menu.

The standard method of determining TDS involves evaporating a sample to dryness at 180 °C and weighing the residue. The TDS factor is calculated by taking the residue weight and dividing it by the sample conductivity. Subsequent conductivity readings are multiplied by the TDS factor to determine the TDS value of the sample.

Conductivity Automatic Calibration

The Orion Star A200 and Star A300 series conductivity meters are capable of automatically recognizing Thermo Scientific Orion 100 µS/cm (Cat. No. 011008), 1413 µS/cm (Cat. No. 011007 and 01100710) and 12.9 mS/cm (Cat. No. 011006 and 01100610) conductivity standards when the nominal cell constant of the conductivity cell is entered in the setup menu.

Table of Conductivity Standard Values vs. Temperature

Cat. No.	011005 01100510	011006 01100610	011007 01100710	01100910	011008
Temperature (°C)	111.9 mS/cm Conductivity Standard (mS/cm)	12.9 mS/cm Conductivity Standard (mS/cm)	1413 µS/cm Conductivity Standard (µS/cm)	147 µS/cm Conductivity Standard (µS/cm)	100 µS/cm Conductivity Standard (µS/cm)
0	65.10	7.135	776	81	54
1	66.84	7.344	799	83	56
2	68.59	7.555	822	86	58
3	70.35	7.768	846	88	59
4	72.12	7.983	870	91	61
5	73.91	8.200	894	93	63
6	75.70	8.418	918	96	64
7	77.50	8.638	943	98	66
8	79.32	8.860	968	101	68
9	81.15	9.084	992	103	70
10	82.98	9.309	1017	106	72
11	84.83	9.535	1043	108	73
12	86.69	9.763	1068	111	75
13	88.56	9.993	1094	114	77
14	90.45	10.22	1119	116	79
15	92.34	10.46	1145	119	81
16	94.24	10.69	1171	122	83
17	96.15	10.93	1198	125	85
18	98.08	11.16	1224	127	87
19	100.0	11.40	1251	130	88
20	102.0	11.64	1277	133	90
21	103.9	11.88	1304	136	92
22	105.9	12.12	1331	138	94
23	107.9	12.36	1358	141	96
24	109.9	12.61	1386	144	98
25	111.9	12.85	1413	147	100

Table of Conductivity Standard Values vs. Temperature (cont.)

Cat. No.	011005 01100510	011006 01100610	011007 01100710	01100910	011008
26	113.9	13.10	1441	150	102
27	115.9	13.35	1468	153	104
28	117.9	13.59	1496	156	106
29	120.0	13.84	1524	159	108
30	122.0	14.09	1552	161	110
31	124.1	14.34	1580	164	112
32	126.2	14.59	1608	167	114
33	128.3	14.85	1636	170	117
34	130.4	15.10	1665	173	119
35	132.5	15.35	1693	176	121
36	134.6	15.61	1722	179	123
37	136.7	15.86	1751	182	125
38	138.9	16.12	1780	185	127
39	141.0	16.37	1808	188	129
40	143.2	16.63	1837	191	131
41	145.4	16.89	1866	194	134
42	147.6	17.15	1896	197	136
43	149.8	17.40	1925	200	138
44	152.0	17.66	1954	203	140
45	154.2	17.92	1983	206	142
46	156.4	18.18	2013	209	145
47	158.7	18.44	2042	212	147
48	160.9	18.70	2071	215	149
49	163.2	18.96	2101	219	151
50	165.4	19.22	2130	222	154

This page intentionally left blank.

Water Analysis Instruments



North America

166 Cummings Center
Beverly, MA 01915 USA
Toll Free: 1-800-225-1480
Tel: 1-978-232-6000
info.water@thermo.com

Netherlands

Tel: (31) 033-2463887
info.water.uk@thermo.com

India

Tel: (91) 22-4157-8800
wai.asia@thermofisher.com

Japan

Tel: (81) 045-453-9175
wai.asia@thermofisher.com

China

Tel: (86) 21-68654588
wai.asi@thermofisher.com

Singapore

Tel: (65) 6778-6876
wai.asia@thermofisher.com

Australia

Tel: (613) 9757-4300
in Australia (1300) 735-296
InfoWaterAU@thermofisher.com
www.thermoscientific.com/water

© 2011 Thermo Fisher Scientific Inc. All rights reserved.

68X576705 RevA 10-11