

YSI Environmental



YSI 556 MPS
Multi Probe System

**Operations
Manual**

Contents

1. Safety	1
1.1 General Information	1
2. General Information	6
2.1 Description	6
2.2 Unpacking the Instrument	7
2.3 Features of the YSI 556 Multi-Probe System	8
2.4 Batteries	9
2.5 Power On	14
2.6 Setting Display Contrast	14
2.7 Backlight	15
2.8 General Screen Features	15
2.9 Keypad Use	16
2.10 Instrument Reset	17
2.11 Menu Flowchart	18
3. Probe Module	18
3.1 Introduction	19
3.2 Unpacking the Probe Module	19
3.3 Features of the YSI 5563 Probe Module	20
3.4 Preparing the Probe Module	20
3.5 Transport/Calibration Cup	24
3.6 Instrument/Cable Connection	25
4. Sensors	26
5. Report	29
6. Calibrate	32
6.1 Getting Ready to Calibrate	32
6.2 Calibration Procedures	35
6.3 Return to Factory Settings	52
7. Run	54
7.1 Real-Time Data	54
8. File	55
8.1 Accessing the File Screen	55
8.2 Directory	56
8.3 View File	58
8.4 Upload to PC	59
8.5 File Memory	63
8.6 Delete All Files	64

9. Logging.....	66
9.1 Accessing the Logging Setup Screen	66
9.2 Setting Logging Interval.....	67
9.3 Storing Barometer Readings.....	67
9.4 Creating a Site List	68
9.5 Editing a Site List	72
9.6 Logging Data Without a Site List.....	72
9.7 Logging Data with a Site List.....	75
9.8 Adding Data to Existing Files	77
10. System Setup.....	79
10.1 Accessing the System Setup Screen	79
10.2 Language Setting	80
10.3 Date and Time Setup	80
10.4 Data Filter.....	82
10.5 Shutoff Time.....	84
10.6 Comma Radix	85
10.7 ID.....	85
10.8 GLP Filename.....	85
10.9 TDS Constant	86
10.10 Barometer Units	87
10.11 Calibrate Barometer	88
11. Maintenance.....	90
11.1 Sensor Care and Maintenance	90
11.2 Upgrading YSI 556 MPS Software	96
12. Storage.....	99
12.1 General Recommendations for Short Term Storage.....	99
12.2 General Recommendations for Long Term Storage	99
13. Troubleshooting.....	102
14. Appendix A YSI 556 MPS Specifications.....	105
15. Appendix B Instrument Accessories.....	106
16. Appendix C Required Federal Communications Notice	107
17. Appendix D Health Safety	108
18. Appendix E Customer Service	111
18.1 Ordering and Technical Support.....	111
18.2 YSI Authorized Service Centers.....	111
18.3 Cleaning Instructions.....	111

Contents

18.4	Packing Procedure	112
18.5	Warranty	113
19.	Appendix F Ferrite Bead Installation.....	114
20.	Appendix G EcoWatch.....	116
20.1	Installing EcoWatch for Windows.....	116
20.2	EcoWatch Tutorial.....	116
21.	Appendix H Calibration Record Information	127
21.1	Viewing the Calibration Record (.glp) File	127
21.2	Uploading the Calibration Record (.glp) File	127
21.3	Understanding the Calibration Record (.glp) File.....	127

1. Safety

1.1 General Information

Read all safety information in this manual carefully before using the YSI 556 Multi-Probe System (MPS). Reagents that are used to calibrate and check this instrument may be hazardous to your health. Take a moment to review Appendix D Health and Safety.

WARNING

Warnings are used in this manual when misuse of the instrument could result in death or serious injury to a person.

CAUTION

Cautions are used in this manual when misuse of the instrument could result in mild or serious injury to a person and/or damage to equipment.

IMPORTANT SAFETY INSTRUCTIONS!

SAVE THESE INSTRUCTIONS!

 In essence, the most important safety rule for use of the YSI 556 MPS is to utilize the instrument **ONLY** for purposes documented in this manual. This is particularly true of the YSI 6117 rechargeable battery pack that contains nickel metal hydride (NiMH) batteries. The user should be certain to read all of the safety precautions outlined below before using the instrument.

Batteries

 This instrument is powered by alkaline or optional nickel-metal hydride batteries, which the user must remove and dispose of when the batteries no longer power the instrument. Disposal requirements vary by country and region, and users are expected to understand and follow the battery disposal requirements for their specific locale.

The circuit board in this instrument contains a manganese dioxide lithium "coin cell" battery that must be in place for continuity of power to memory devices on the board. This battery is not user serviceable or replaceable.

When appropriate, an authorized YSI service center will remove this battery and properly dispose of it, per service and repair policies.

YSI Rechargeable Battery Pack Safety Information

Restrictions on Usage

1. Never dispose of the battery pack in a fire.
2. Do not attempt to disassemble the YSI 6117 battery pack
3. Do not tamper with any of the electronic components or the batteries within the battery pack. Tampering with either the electronic circuitry or the batteries will result in the voiding of the warranty and the compromising of the system performance, but, more importantly, can cause safety hazards which result from overcharging such as overheating, venting of gas, and loss of corrosive electrolyte.
4. Do not charge the battery pack outside the 0–40°C temperature range.
5. Do not use or store the battery at high temperature, such as in strong direct sunlight, in cars during hot weather, or directly in front of heaters.
6. Do not expose the battery pack to water or allow the terminals to become damp.
7. Avoid striking or dropping the battery pack. If the pack appears to have sustained damage from these actions or malfunctions after an impact or drop, the user should not attempt to repair the unit. Instead, contact YSI Customer Service. Refer to *Appendix E Customer Service*.
8. If the battery pack is removed from the YSI 556 MPS, do not store it in pockets or packaging where metallic objects such as keys can short between the positive and negative terminals.

Precautions for Users with Small Children.

Keep the battery pack out of reach of babies and small children.

Danger Notifications – Misuse creates a STRONG possibility of death or serious injury.

FAILURE TO CAREFULLY OBSERVE THE FOLLOWING PROCEDURES AND PRECAUTIONS CAN RESULT IN LEAKAGE OF BATTERY FLUID, HEAT GENERATION, BURSTING, AND SERIOUS PERSONAL INJURY.

1. Never dispose of the battery pack in a fire or in heat.
2. Never allow the positive and negative terminals of the battery pack to become shorted or connected with electrically conductive materials. When the battery pack has been removed from the YSI 556 MPS, store it in a heavy plastic bag to prevent accidental shorting of the terminals.
3. Never disassemble the battery pack and do not tamper with any of the electronic components or the batteries within the battery pack. The battery pack is equipped with a variety of safety features. Accidental deactivation of any of these safety features can cause a serious hazard to the user.
4. The NiMH batteries in the battery pack contain a strong alkaline solution (electrolyte). The alkaline solution is extremely corrosive and will cause damage to skin or other tissues. If any fluid from the battery pack comes in contact with a user's eyes, immediately flush with clean water and consult a physician immediately. The alkaline solution can damage eyes and lead to permanent loss of eyesight.



Warning Notifications – Misuse creates a possibility of death or serious injury

1. Do not allow the battery pack to contact freshwater, seawater, or other oxidizing reagents that might cause rust and result in heat generation. If a battery becomes rusted, the gas release vent may no longer operate and this failure can result in bursting.
2. If electrolyte from the battery pack contacts the skin or clothing, thoroughly wash the area immediately with clean water. The battery fluid can irritate the skin.



Caution Notifications – Misuse creates a possibility of mild or serious injury or damage to the equipment.

1. Do not strike or drop the battery pack. If any impact damage to the battery pack is suspected, contact YSI Customer Service. Refer to *Appendix E Customer Service*.

2. Store the battery pack out of reach of babies and small children.
3. Store the battery pack between the temperatures of -20 and 30°C.
4. Before using the battery pack, be sure to read the operation manual and all precautions carefully. Then store this information carefully to use as a reference when the need arises.

YSI 616 Cigarette Lighter Charger Safety Information

1. This section contains important safety and operating instructions for the YSI 556 MPS cigarette lighter battery charger (YSI 616; RadioShack Number 270-1533E). **BE SURE TO SAVE THESE INSTRUCTIONS.**
2. Before using the YSI 616 cigarette lighter charger, read all instructions and cautionary markings on battery charger, battery pack, and YSI 556 MPS.
3. Charge the YSI 6117 battery pack with the YSI 616 cigarette lighter charger **ONLY** when the YSI 6117 is installed in the YSI 556 MPS.
4. Do not expose charger to rain, moisture, or snow.
5. Use of an attachment not recommended or sold by the battery charger manufacturer may result in a risk of fire, electric shock, or injury to persons.
6. To reduce risk of damage to cigarette lighter and cord, pull by cigarette lighter rather than cord when disconnecting charger.
7. Make sure that the cord is located so that it will not be stepped on, tripped over, or otherwise subjected to damage or stress.
8. Do not operate charger with damaged cord or cigarette lighter connector – replace it immediately.
9. Do not operate charger if it has received a sharp blow, been dropped, or otherwise damaged in any way; contact YSI Customer Service. Refer to *Appendix E Customer Service*.
10. Do not disassemble charger other than to change the fuse as instructed. Replace the part or send it to YSI Product Service if repair is required (refer to *Appendix E Customer Service*). Incorrect reassembly may result in a risk of electric shock or fire.

11. To reduce risk of electric shock, unplug charger before attempting any maintenance or cleaning. Turning off controls will not reduce this risk.

YSI 556 MPS Water Leakage Safety Information

The YSI 556 MPS has been tested and shown to comply with IP67 criterion, i.e. submersion in 1 meter of water for 30 minutes with no leakage into either the battery compartment or the main case. However, if the instrument is submersed for periods of time in excess of 30 minutes, leakage may occur with subsequent damage to the batteries, the rechargeable battery pack circuitry, and/or the electronics in the main case.

If leakage into the battery compartment is observed when using alkaline C cells, remove batteries, dispose of batteries properly, and dry the battery compartment completely, ideally using compressed air. If corrosion is present on the battery terminals, contact YSI Customer Service for instructions. Refer to *Appendix E Customer Service*.

If leakage into the battery compartment is observed when using the YSI rechargeable battery pack, remove the battery assembly and set aside to dry. Return the battery pack to YSI Product Service for evaluation of possible damage. Finally dry the battery compartment completely, ideally using compressed air. If corrosion is present on the battery terminals, contact YSI Customer Service for instructions. Refer to *Appendix E Customer Service*.

 **CAUTION:** If water has contacted the rechargeable battery pack, do not attempt to reuse it until it has been evaluated by YSI Product Service (refer to Appendix E Customer Service). Failure to follow this precaution can result in serious injury to the user.

If it is suspected that leakage into the main cavity of the case has occurred, remove the batteries immediately and return the instrument to YSI Product Service for damage assessment. Refer to *Appendix E Customer Service*.

 **CAUTION:** Under no circumstances should the user attempt to open the main case.

2. General Information

2.1 Description

The rugged and reliable YSI 556 MPS (Multi-Probe System) combines the versatility of an easy-to-use, easy-to-read handheld unit with all the functionality of a multi-parameter system. Featuring a waterproof, impact-resistant case, the YSI 556 MPS simultaneously measures dissolved oxygen, conductivity, temperature, and optional pH and ORP. A simple cellular phone style keypad and large display make the instrument easy to use. The YSI 556 MPS is compatible with YSI EcoWatchTM for WindowsTM software.

The YSI 556 MPS assists the user in conforming to Good Laboratory Practice (GLP) standards which help ensure that quality control/quality assurance methods are followed. Battery life is displayed with a fuel gauge, and the user can choose standard alkaline batteries or an optional rechargeable battery pack.

The 1.5 MB memory can store more than 49,000 data sets. Other options include a flow cell and barometer. The internal barometer can be user-calibrated and displayed along with other data, used in dissolved oxygen calibrations, and logged to memory for tracking changes in barometric pressure.

Features

- Waterproof -meets IP67 specifications
- Field-replaceable DO electrode module; pH and pH/ORP sensors
- Compatible with EcoWatchTM for WindowsTM data analysis software
- Assists with Good Laboratory Practice Standards (GLP)
- Choice of DO membrane material for different applications
- Easy-to-use, screw-on cap DO membranes
- User-upgradeable software from YSI website
- Three-year warranty on the instrument; one-year on the probe modules
- Available with 4,10, and 20 m cable lengths
- Stores over 49,000 data sets, time and date stamped

- Auto temperature compensating display contrast
- Optional barometer
- Optional rechargeable battery pack or standard alkaline batteries

2.2 Unpacking the Instrument

1. Remove the instrument from the shipping box. Note that the probe module and sensors are shipped in a separate box and will be unpacked later in Section 3.2 *Unpacking the Probe Module*

NOTE: Do not discard any parts of supplies.

2. Use the packing list to ensure all items are present.
3. Visually inspect all components for damage.

NOTE: If any parts are missing or damaged, contact your YSI Service Center immediately. Refer to Appendix E Customer Service or www.ysi.com.

2.3 Features of the YSI 556 Multi-Probe System

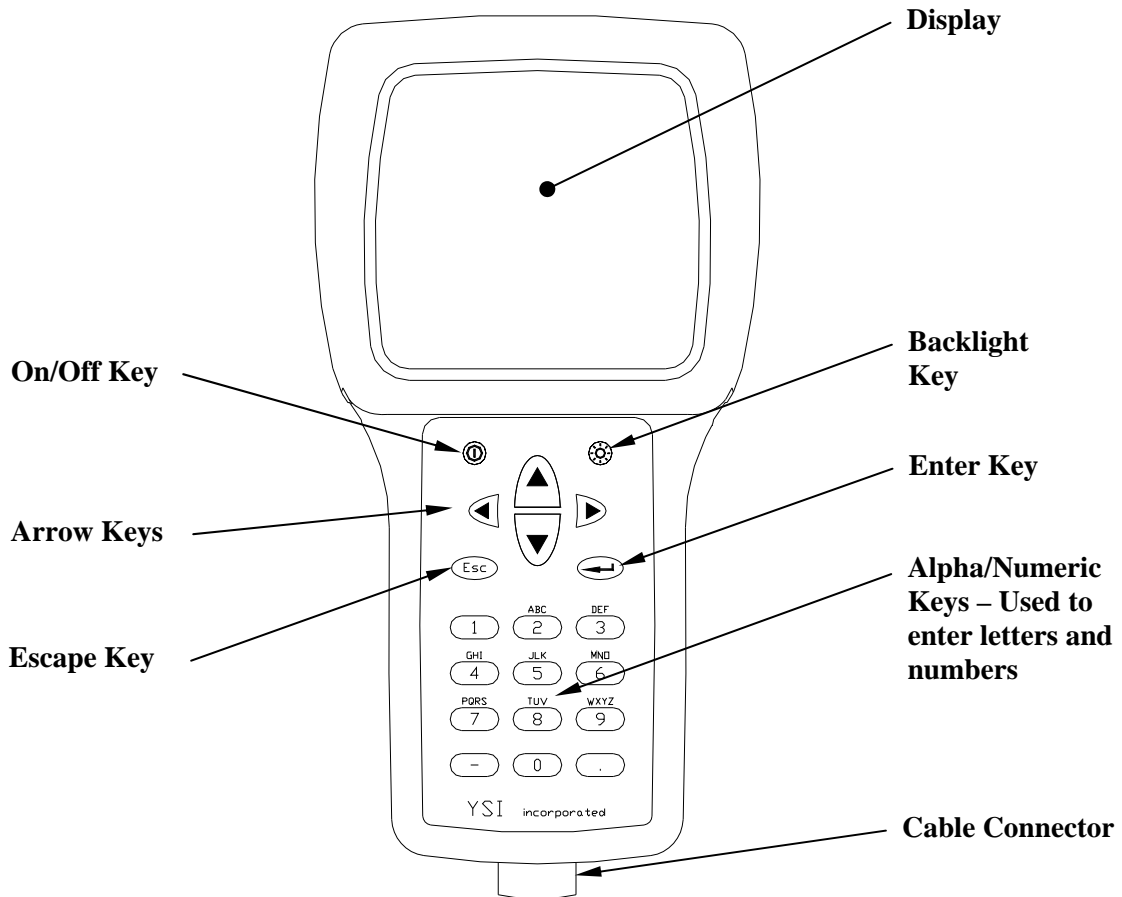

Figure 2.1 Front View of YSI 556 MPS

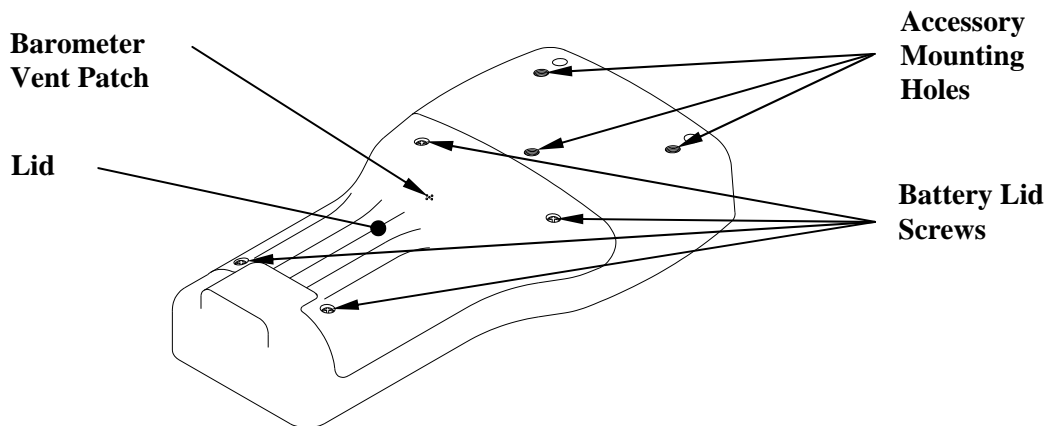

Figure 2.2 Back View of YSI 556 MPS

2.4 Batteries

2.4.1 Battery Life

Standard Alkaline Batteries

With the standard battery configuration of 4 alkaline C cells, the YSI 556 MPS will operate continuously for approximately 180 hours. Assuming a standard usage pattern when sampling of 3 hours of “on time” in a typical day, the alkaline cells will last approximately 60 days.

Optional Rechargeable Battery Pack

When fully charged, the optional rechargeable battery pack will provide approximately 50 hours of battery life.

2.4.2 Inserting 4 C Batteries

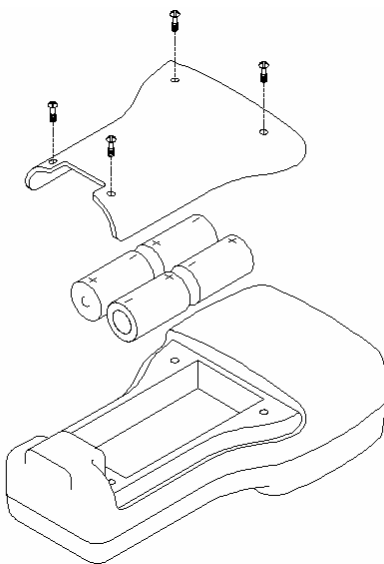

Figure 2.1 Inserting C Cells



CAUTION: Install batteries properly to avoid damage to the instrument.

1. Loosen the four screws in the battery lid on the back of the instrument using any screwdriver.
2. Remove the battery lid.
3. Insert four C batteries between the clips following the polarity (+ and -) labels on the bottom of the battery compartment.
4. Check gasket for proper placement on the battery lid.
5. Replace the battery lid and tighten the 4 screws securely and evenly.

NOTE: Do not over-tighten the screws.

2.4.3 Inserting Optional Rechargeable Battery Pack

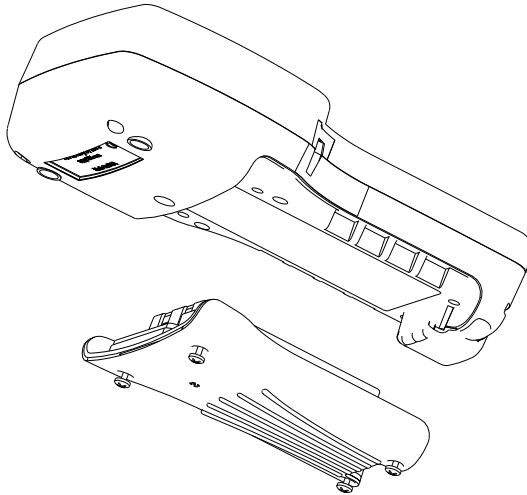

Figure 2.2 Inserting Battery Pack

⚠ CAUTION: Read all cautions and warning that come with the battery pack before using the battery pack.

1. Loosen the four screws in the battery lid on the back of the instrument using any screwdriver.
2. Remove the C battery lid and store for future use. Remove C batteries, if installed.
3. Install the rechargeable battery pack and lid and tighten the 4 screws securely and evenly.

NOTE: Do not over tighten the screws.

2.4.4 Charging the Optional Rechargeable Battery Pack

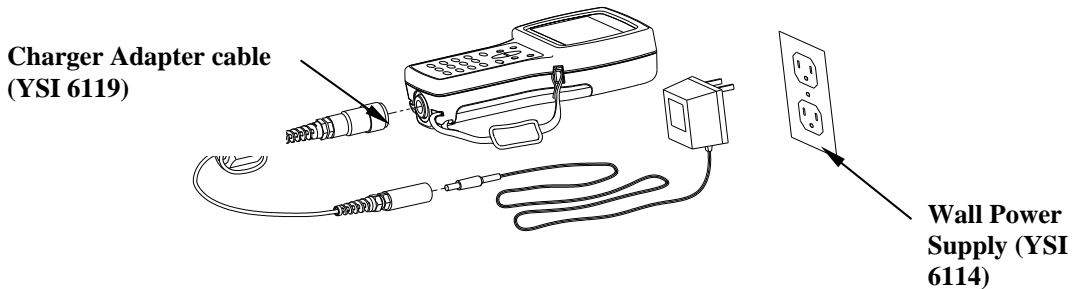

Figure 2.3 Charging the Battery Pack

⚠ CAUTION: Do not use or store the battery pack at extreme temperatures such as in strong direct sunlight, in cars during hot weather or close to heaters.

1. Install the rechargeable battery pack into the instrument as described in Section 2.4.3 *Inserting Optional Rechargeable Battery Pack*.
2. Attach the charger adapter cable (YSI 6119) to the instrument.

NOTE: Wall power supplies for use in countries outside the US and Canada can be found in *Appendix B Instrument Accessories*.

3. Insert the barrel connector of the wall power supply into the barrel of the adapter cable.

⚠ CAUTION: Do not charge the battery pack continuously for more than 48 hours.

⚠ CAUTION: Do not drop or expose to water.

⚠ CAUTION: Do no charge the battery pack at temperatures below 0°C or above 40°C.

4. Plug the wall power supply into an AC power outlet for approximately 2 hours to obtain an 80% to 90% charge for 6 hours to get a full charge.

NOTE: The battery pack can be recharged whether the instrument is on or off.

2.4.5 Storing the Battery Pack

Remove the battery pack from the instrument when the instrument will not be used for extended periods of time to prevent over discharge of the battery pack.

Store the battery pack in a heavy plastic bag to prevent accidental shorting of the terminals. Store between -20 and 30°C .

2.4.6 Optional Cigarette Lighter Charger

 **CAUTION: Read all warnings and cautions that come with the charger before using the charger.**

 **CAUTION: Only use cigarette lighter charger when rechargeable battery pack is inserted into instrument.**

 **CAUTION: Do not mishandle cigarette lighter charger. Do not expose to moisture.**

1. Plug the barrel connector of the cigarette lighter charger into the mating end of the YSI 6119 Charger Adapter Cable.
2. Attach the MS-19 end of the YSI 6119 Charger Adapter Cable to the instrument.
3. Make one of the following modifications to the other end of the charger:

Slide the adapter ring off the plug to use the device with an American or Japanese vehicle.

American and Japanese Vehicles

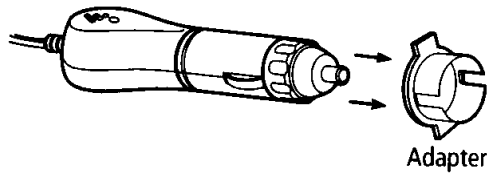

Figure 2.1 Charger Plug Adapter Use

Leave the adapter ring on the plug and position it so that the slots on the adapter ring line up with the plug's spring clips to use the device on a European vehicle.

European Vehicles

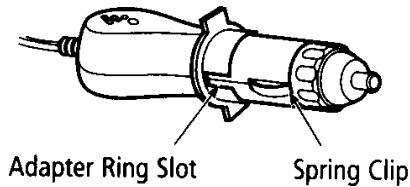

Figure 2.2 European Charger Plug Adapter Use

NOTE: If the charger stops working properly, refer to Section 13 *Troubleshooting*.

2.5 Power On

Press and release the on/off button in the upper left corner of the instrument keypad to turn the instrument on or off. See Figure 2.1 Front View of YSI 556 MPS.

2.6 Setting Display Contrast

The display contrast automatically compensates for temperature changes. However, under extreme temperature conditions you may wish to optimize the display by manual adjustment as follows:

1. Press and *hold down* the backlight key in the upper right corner of the keypad and press the “up” arrow to increase (darken) the contrast.
2. Press and *hold down* the backlight key in the upper right corner of the keypad and press the “down” arrow to decrease (lighten) the contrast.

2.7 Backlight

Press and *release* the backlight key in the upper right corner of the keypad to turn the backlight on or off. See Figure 2.1 Front View of YSI 556 MPS.

NOTE: The backlight turns off automatically after two minutes of non-use.

2.8 General Screen Features

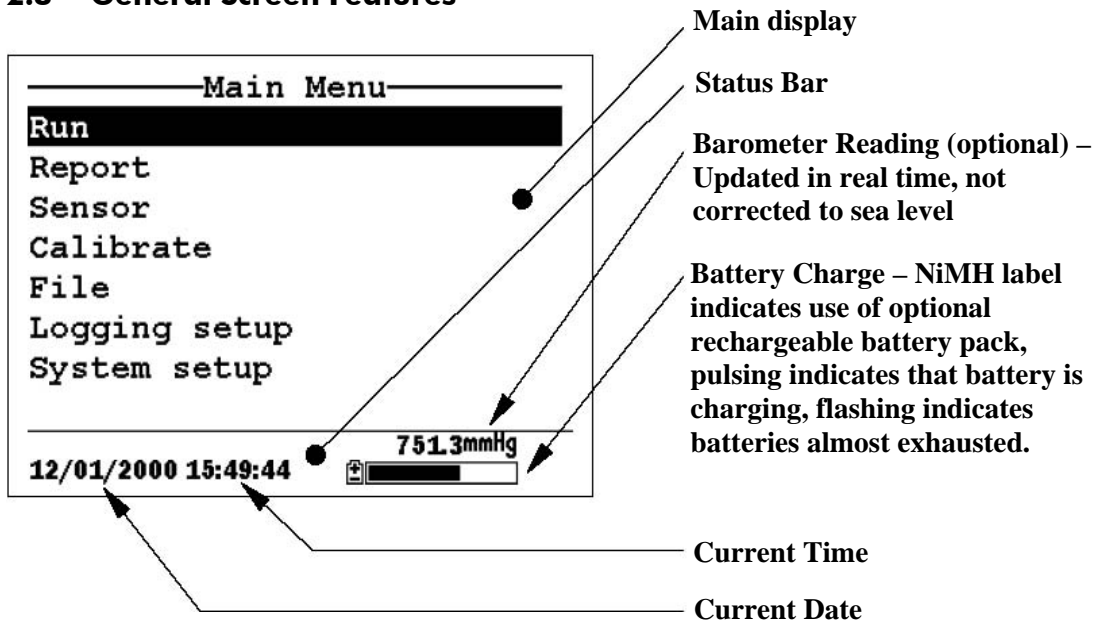

Figure 2.4 Main Screen Menu

2.9 Keypad Use

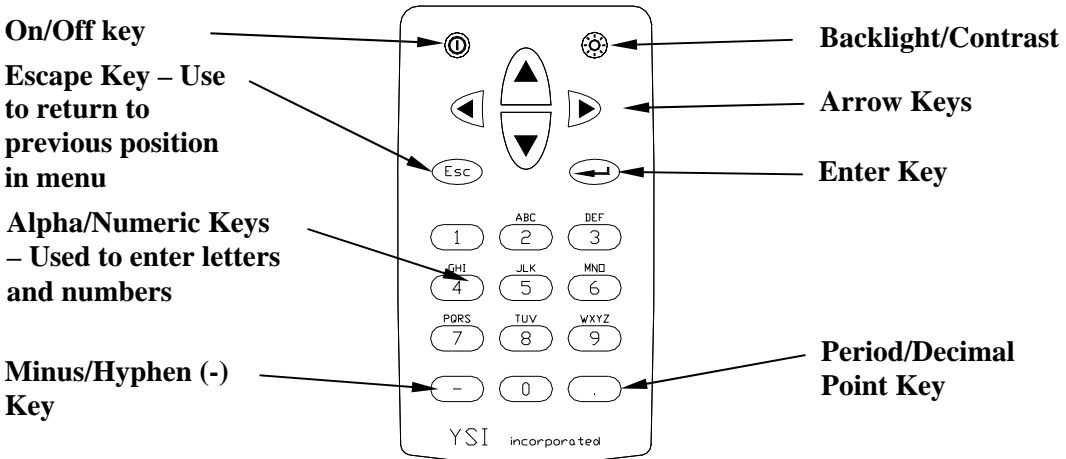

Figure 2.5 Keypad Features

KEY	LETTER/NUMBER
1	1
2	ABC2abc3
3	DEF3def3
4	GHI4ghi4
5	JKL5jkl5
6	MNO6mno6
7	PQRS7pqrs7
8	TUV8tuv8
9	WXYZ9wxyz9
0	0

Figure 2.6 Keypad Features

1. See Figure 2.10 Keypad Letters & Numbers and press the appropriate key repeatedly until letter or number desired appears in display.

NOTE: Press the key repeatedly in rapid succession to get to the desired letter or number. If you pause for more than a second, the cursor automatically scrolls to the right to prepare for the next input.

EXAMPLE 1: Press the **6** key *once* and *release* to display an uppercase “M”.

EXAMPLE 2: Press the **6** key *four times* and *release* to display the number “6”.

EXAMPLE 3: Press the **6** key *five times* and *stop* to display a lowercase “m”.

2. Press the left arrow key to go back and reenter a number or setter that needs to be changed.

Press the **Enter** key when your entry is complete.

NOTE: The instrument software permits only numeric entries in many instances, such as when setting the clock or entering calibration parameters.

2.10 Instrument Reset

The YSI 556 MPS is characterized by sophisticated software that should provide trouble-free operation. However, as with all high-capability software packages, it is always possible that the user will encounter circumstances in which the instrument does not respond to keypad entry. If this occurs, the instrument function can easily be restored by removing and then reapplying battery power. Simply remove either your C-cells or rechargeable battery pack from the battery compartment, wait 30 seconds and then replace the batteries. See Section 2.4 *Batteries* for battery removal/reinstallation instructions.

2.11 Menu Flowchart

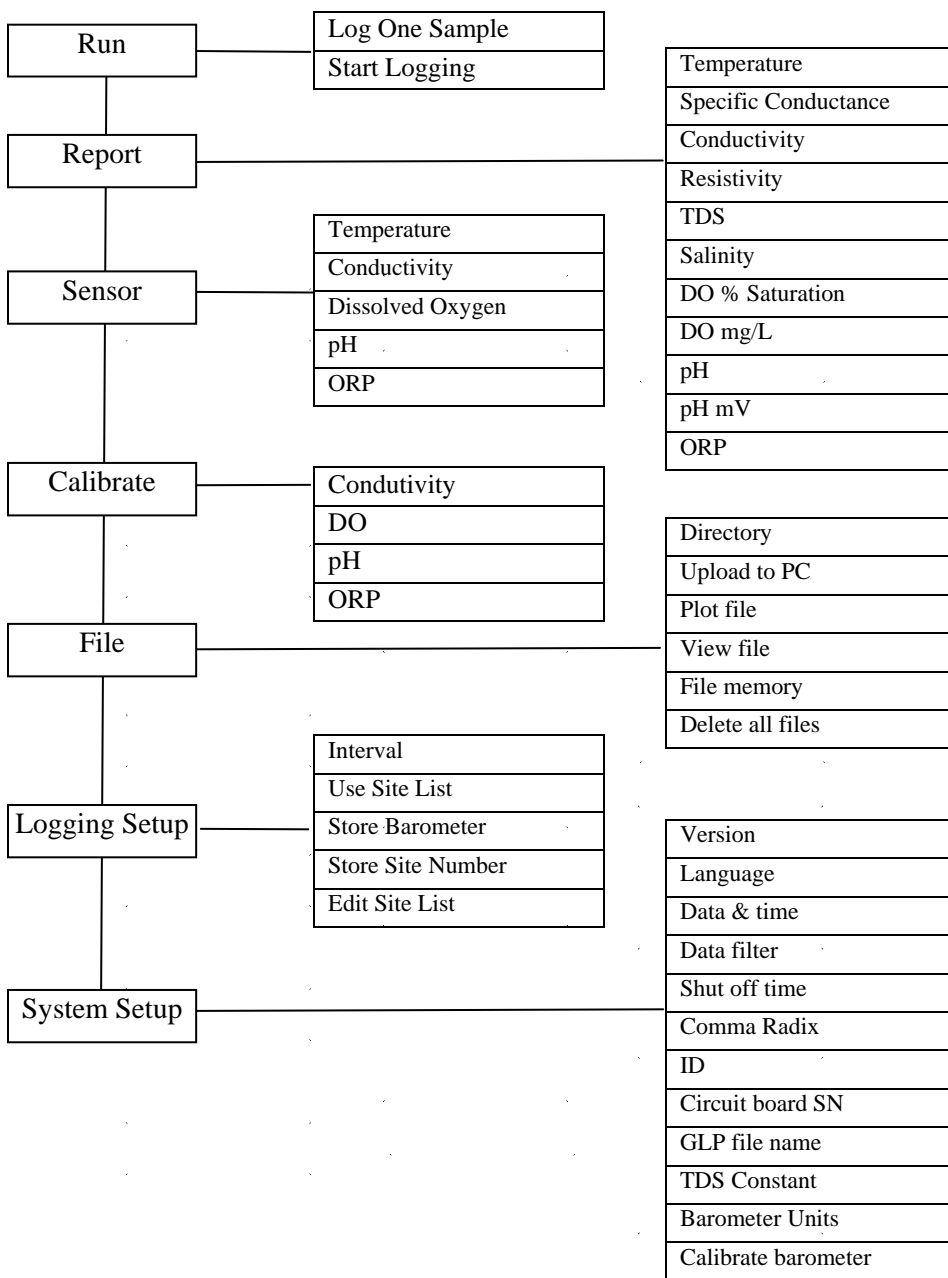

3. Probe Module

3.1 Introduction

The YSI 5563 Probe module is used for measuring dissolved oxygen, temperature, conductivity, and optional pH and ORP. The probe module is rugged, with the sensors enclosed in a heavy duty probe sensor guard with attached sinking weight. A 4, 10 or 20 meter cable is directly connected to the probe module body making it waterproof. An MS-19 connector at the end of the cable makes the YSI 5563 fully compatible with the YSI 556 Multi-Probe System.

3.2 Unpacking the Probe Module

1. Remove the YSI 5563 Probe Module from the shipping boxes.

NOTE: Do not discard any parts or supplies.

2. Use the packing list to ensure all items are present.
3. Visually inspect all components for damage.

NOTE: If any parts are missing or damaged, contact a YSI representative immediately. Refer to: *Appendix E Customer Service* or visit www.ysi.com.

3.3 Features of the YSI 5563 Probe Module

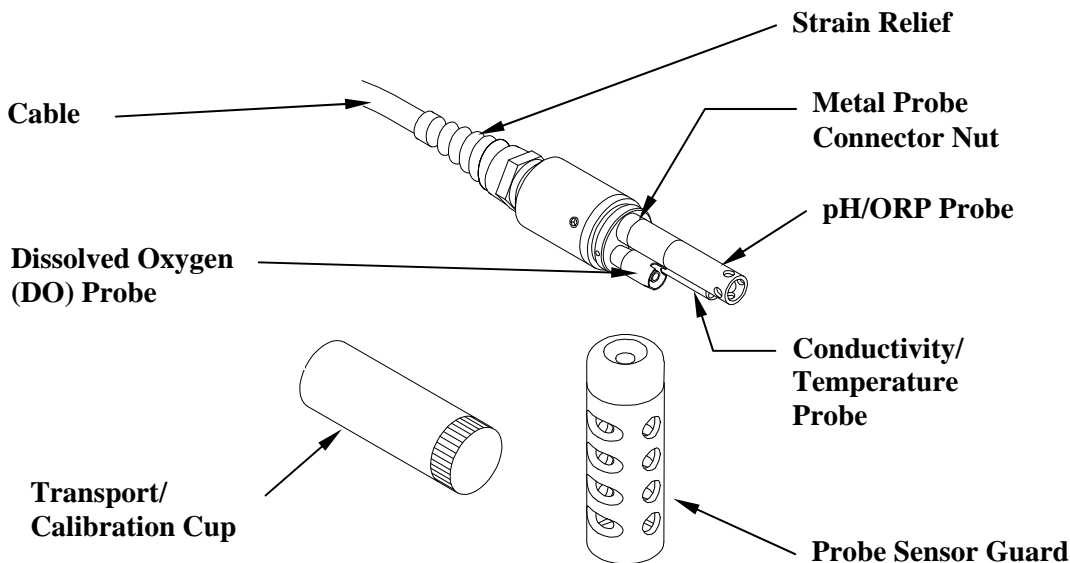

Figure 3.1 Probe Module

3.4 Preparing the Probe Module

To prepare the probe module for calibration and operation, you need to install the sensors into the connectors on the probe module bulkhead. In addition to sensor installation, you need to install a new DO membrane cap.

3.4.1 Sensor Installation

Whenever you install, remove or replace a sensor, it is extremely important that the entire probe module and all sensors be thoroughly dried prior to the removal of a sensor or a sensor port plug. This will prevent water from entering the port. Once you remove a sensor or plug, examine the connector inside the probe module sensor port. If any moisture is present, use compressed air to completely dry the connector. If the connector is corroded, return the probe module to your YSI Distributor or directly to YSI Customer Service. Refer to *Appendix E Customer Service*.

Conductivity/Temperature and pH, pH/ORP Sensor Installation

1. Unscrew and remove the probe sensor guard.
2. Using the sensor installation tool supplied in the YSI 5511 maintenance kit, unscrew and remove the sensor port plugs.

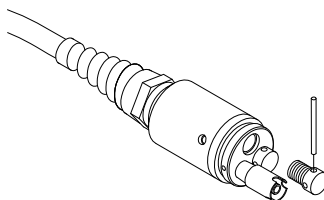

Figure 3.2 Port Plug Removal

3. Locate the port with the connector that corresponds to the sensor that is to be installed.

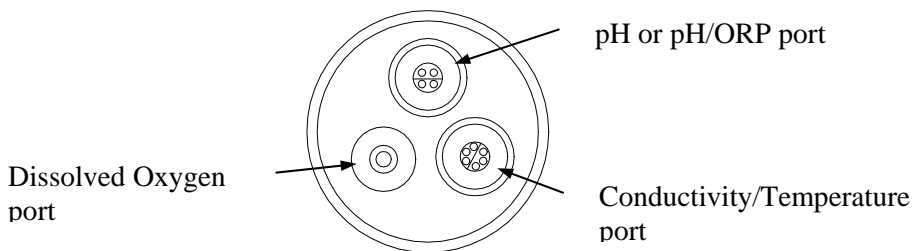

Figure 3.3 Sensor Port Identification

4. Apply a thin coat of o-ring lubricant (supplied in the YSI 5511 maintenance kit) to the o-rings on the connector side of the sensor (see Figure 3.4 O-ring Lubrication).

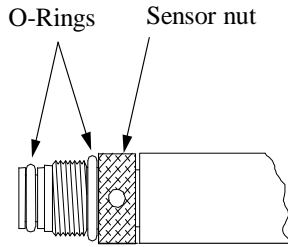

Figure 3.4 O-ring Lubrication

⚠ CAUTION: Make sure that there are NO contaminants between the o-ring and the sensor. Contaminants that are present under the o-ring may cause the o-ring to leak.

5. Be sure the probe module sensor port is free of moisture and then insert the sensor into the correct port. Gently rotate the sensor until the two connectors align.
6. With the connectors aligned, screw down the sensor nut using the sensor installation tool.

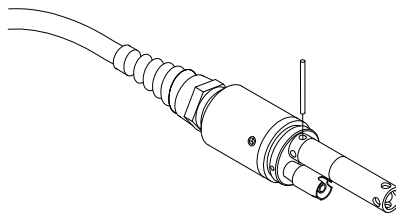

Figure 3.5 Sensor Installation

⚠ CAUTION: Do not cross thread the sensor nut. Tighten the nut until it is flush with the face of the probe module bulkhead. Do not over tighten.

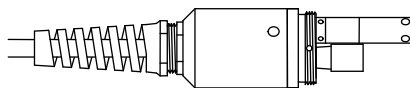

Figure 3.6 Bulkhead Seating

7. Repeat steps 3-6 for any other sensors.

8. Replace the probe sensor guard.

Dissolved Oxygen Sensor Installation

The YSI 5563 comes with the DO sensor already installed. Refer to Section *11.1.2 DO Sensor Replacement* for instructions on installing the YSI 559 Replaceable DO Module Kit.

3.4.2 Membrane Cap Selection

The YSI 5563 is shipped with a YSI 5909 kit that contains membrane caps made with 2 mil polyethylene (PE), a material which should be ideal for most field applications of the 556. However, YSI also offers membrane caps made with two other materials (1 mil polyethylene and 1 mil Teflon) which some users may also prefer. All membranes available for the 556/5563 system provide comparable accuracy if used properly. The difference between the two thicknesses of PE is found in the trade-off of flow dependence and response time as described below. Teflon is offered because some users may prefer to continue using the traditional membrane material used by YSI. To avoid confusion, the membrane caps are color coded as described below and can be ordered in kits as noted:

1 mil Teflon – Black Caps (Kit = YSI 5906)

1 mil Polyethylene (PE) – Yellow Caps (Kit = YSI 5908)

2 mil Polyethylene (PE) – Blue Caps (Kit = YSI 5909)

The 1 mil Teflon caps will offer traditional, reliable performance for most dissolved oxygen applications. The 1 mil PE caps will provide a significantly faster dissolved oxygen response (as long as your 556 Data Filter is set correctly as described below in Sections 10.2 and 10.3.1) while also giving readings which are significantly less flow dependent than the 1 mil Teflon caps. Finally, 2 mil PE caps will show a large reduction in flow dependence over 1 mil Teflon while not significantly increasing the response time. Generally, one of the PE caps is likely to provide better performance for your application.

IMPORTANT: No matter which type of membrane cap you select, you will have to confirm your selection in the 556 software from the Sensor menu as described in Section *4 Sensors*.

3.4.3 Membrane Cap Installation

NOTE: The YSI 5563 DO sensor (already installed in the probe module) was shipped dry. A shipping membrane was installed to protect the electrode. **A new membrane cap must be installed before the first use.**

1. Unscrew and remove the probe sensor guard.
2. Unscrew, remove, and discard the old membrane cap.
3. Thoroughly rinse the sensor tip with distilled water.
4. Prepare the electrolyte according to the directions on the electrolyte solution bottle.
5. Hold the new membrane cap and fill it at least ½ full with the electrolyte solution.
6. Screw the membrane cap onto the sensor moderately tight. A small amount of electrolyte should overflow.



Caution: Do not touch the membrane surface.

7. Screw the probe sensor guard on moderately tight.

3.5 Transport/Calibration Cup

The YSI 5563 Probe module has been supplied with a convenient transport/calibration cup. This cup is an ideal container for calibration of the different sensors, minimizing the amount of solution needed. Refer to Section 6 *Calibrate*.

3.5.1 Transport/Calibration Cup Installation

1. Remove probe sensor guard, if already installed.
2. Ensure that an o-ring is installed in the o-ring groove on the threaded end of the probe module body.
3. Screw the transport/calibration cup on the threaded end of the probe module and securely tighten.

NOTE: Do not over tighten as this could cause damage to the threaded portions.

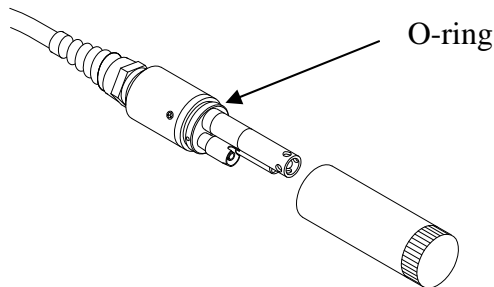

Figure 3.7 Transport/Calibration Cup Installation

3.6 Instrument/Cable Connection

Attach the cable to the instrument as follows:

1. Line up the pins and guides on the cable with the holes and indentations on the cable connector at the bottom of the YSI 556 instrument. See Figure 2.1 Front View of YSI 556 MPS.
2. Holding the cable firmly against the cable connector, turn the locking mechanism clockwise until it snaps into place.

Remove the cable from the instrument by turning the cable connector counterclockwise until the cable disengages from the instrument.

4. Sensors

The Sensors screen allows the user to enable or disable each of the sensors and select which membrane material will be used for the dissolved oxygen sensor. Disabled sensors will not be displayed on the screen in real time or logged to files.

1. Press the **On/off** key to display the run screen.
2. Press the **Escape** key to display the main menu screen.

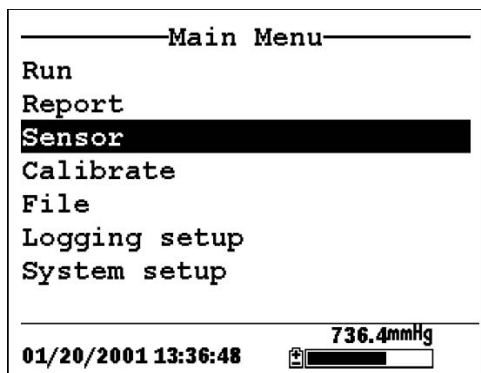

Figure 4.1 Main Menu Screen

3. Use the arrow keys to highlight the **Sensor** selection.
4. Press the **Enter** key to display the sensors enabled screen.

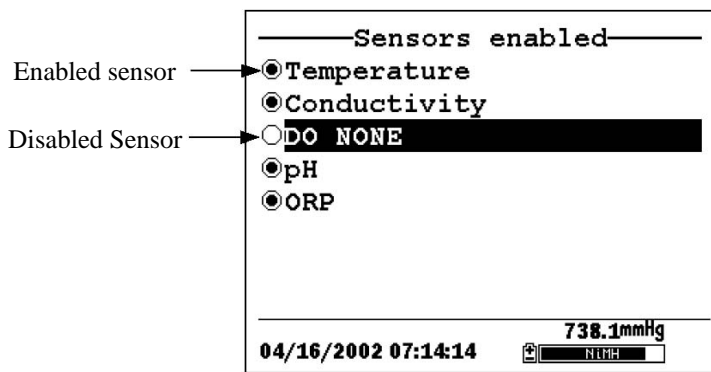
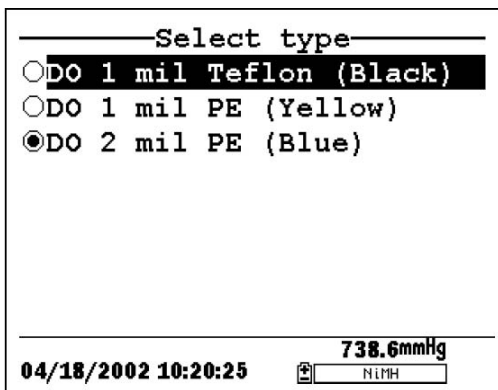

Figure 4.2 Sensors Enabled Screen Before DO Membrane Selection

A black dot to the left of a sensor indicates that sensor is enabled. Sensors with an empty circle are disabled.

Highlight the “DO None” entry as shown above and press **Enter** to display the membrane choice screen. Consult Section 3.4.2 *Membrane Cap Selection* for information on the advantages of each type of membrane material. Blue membrane caps using 2 mil polyethylene (PE) were shipped with your YSI 5563 and are likely to be the best choice for most 556 field applications.

**Figure 4.3 Membrane Selection Screen**

Highlight the desired membrane choice – in this case, 2 mil PE - and press Enter to activate your selection with a dot to the left of the screen. Then press **Escape** to return to the Sensor menu that now shows your DO membrane selection.

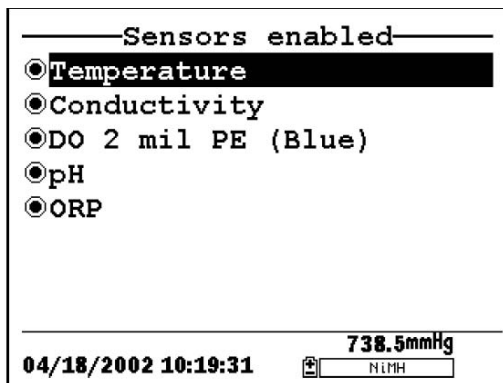

Figure 4.4 Sensors Enabled Screen After DO Membrane Selection

NOTE: The Temperature sensor cannot be disabled. Most other sensors require temperature compensation for accurate readings. In addition, the conductivity sensor must be activated in order to obtain accurate dissolved oxygen mg/L readings.

5. Use the arrow keys to highlight the sensor you want to change, then press the Enter key to enable or disable it.
6. Repeat step 5 for each sensor you want to change.
7. Press the Escape key to return to the main menu screen.

5. Report

The Report Setup screen allows the user to select which sample parameters and units the YSI 556 MPS will display on the screen. It does NOT determine which parameters are logged to memory. Refer to Section 4 *Sensors*.

1. Press the **On/off** key to display the run screen.
2. Press the **Escape** key to display the main menu screen.

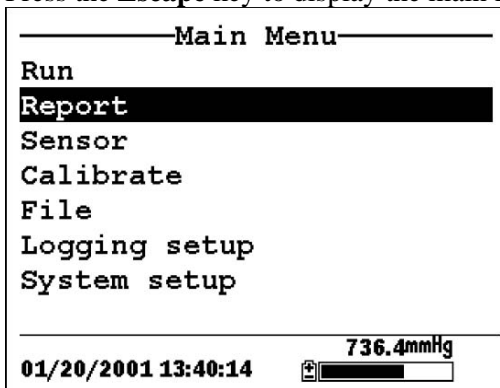

Figure 5.1 Main Menu

3. Use the arrow keys to highlight the **Report** selection.
4. Press the **Enter** key to display the report setup screen.

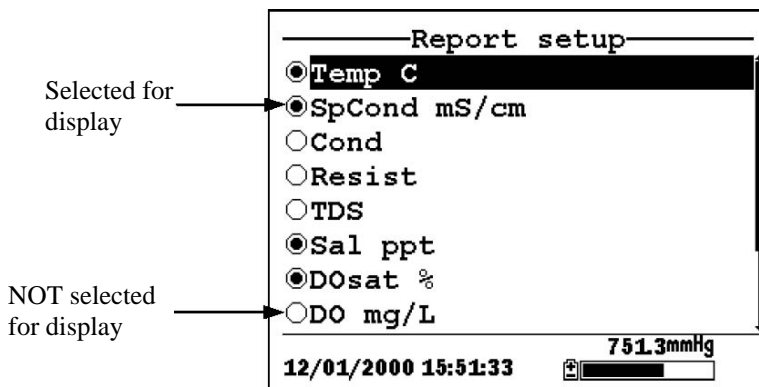

Figure 5.2 Report Setup Screen

NOTE: A black dot to the left of a parameter indicates that parameter is selected for display. Parameters with an empty circle will not be displayed.

NOTE: You may have to scroll down past the bottom of the screen to see all the parameters.

5. Use the arrow keys to highlight the parameter you want to change, then press the **Enter** key. If you can't find the parameter you want, even after scrolling down past the bottom of the screen, the sensor used for that parameter is disabled. Refer to Section 4 *Sensors*.
6. If you selected Temperature, Specific Conductivity, Conductivity, Resistance or Total Dissolved Solids, the Units screen will appear.

—————Select units—————

NONE

Temp C

Temp F

Temp K

01/20/2001 13:40:55 736.4mmHg

Figure 5.3 Units Screen

7. Use the arrow keys to select the units desired, then press the **Enter** key to return to the report setup screen.
8. Repeat steps 5 and 6 for each parameter you want to change.

NOTE: Specific Conductance (temperature compensated conductivity) is notated on the Run screen with a small 'c' after the units of measure.

All parameters may be enabled at the same time.

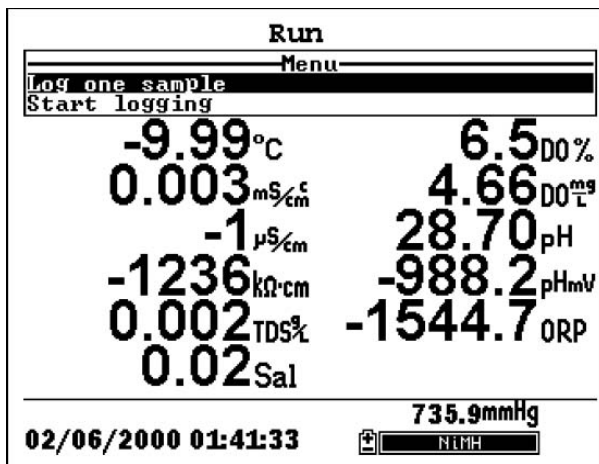



Figure 5.4 All Parameters Displayed

9. Press the **Escape** key to return to the Main menu screen.

6. Calibrate

All of the sensors, except temperature, require periodic calibration to assure high performance. You will find specific calibration procedures for all sensors that require calibration in the following sections. If a sensor listed is not installed in your probe module, skip that section and proceed to the next sensor until the calibration is complete.

 **CAUTION:** Reagents that are used to calibrate and check this instrument may be hazardous to your health. Take a moment to review *Appendix D Health and Safety*. Some calibration standard solutions may require special handling.

6.1 Getting Ready to Calibrate

6.1.1 Containers Needed to Calibrate the Probe Module

The transport/calibration cup that comes with your probe module serves as a calibration chamber for all calibrations and minimizes the volume of calibration reagents required.

Instead of the transport/calibration cup, you may use laboratory glassware to perform calibrations. If you do not use the transport/calibration cup that is designed for the probe module, you are cautioned to do the following:

- ✓ Perform all calibrations with the Probe Sensor Guard installed. This protects the sensors from possible physical damage.
- ✓ Use a ring stand and clamp to secure the probe module body to prevent the module from falling over. Most laboratory glassware has convex bottoms.
- ✓ Ensure that all sensors are immersed in calibration solutions. Many of the calibrations factor in readings from other sensors (e.g., temperature sensor). The top vent hole of the conductivity sensor must also be immersed during some calibrations.

6.1.2 Calibration Tips

1. If you use the Transport/Calibration Cup for dissolved oxygen (DO) calibration, make certain to loosen the seal to allow pressure equilibration before calibration. The DO calibration is a water-saturated air calibration.
2. When calibrating pH, always calibrate with buffer 7 first, regardless if performing a 1, 2, or 3 point calibration
3. The key to successful calibration is to ensure that the sensors are completely submersed when calibration values are entered. Use recommended volumes when performing calibrations.
4. For maximum accuracy, use a small amount of previously used calibration solution to pre-rinse the probe module. You may wish to save old calibration standards for this purpose.
5. Fill a bucket with ambient temperature water to rinse the probe module between calibration solutions.
6. Have several clean, absorbent paper towels or cotton cloths available to dry the probe module between rinses and calibration solutions. Shake the excess rinse water off of the probe module, especially when the probe sensor guard is installed. Dry off the outside of the probe module and probe sensor guard. Making sure that the probe module is dry reduces carry-over contamination of calibrator solutions and increases the accuracy of the calibration.
7. If you are using laboratory glassware for calibration, you do not need to remove the probe sensor guard to rinse and dry the sensors between calibration solutions. The inaccuracy resulting from simply rinsing the sensor compartment and drying the outside of the guard is minimal.
8. If you are using laboratory glassware, remove the stainless steel weight from the bottom of the probe sensor guard by turning the weight counterclockwise. When the weight is removed, the calibration solutions have access to the sensors

without displacing a lot of fluid. This also reduces the amount of liquid that is carried between calibrations.

9. Make certain that port plugs are installed in all ports where sensors are not installed. It is extremely important to keep these electrical connectors dry.

6.1.3 Recommended Volumes

Follow these instructions to use the transport/calibration cup for calibration procedures.

- ✓ Ensure that an o-ring is installed in the o-ring groove of the transport/calibration cup bottom cap, and that the bottom cap is securely tightened.

NOTE: Do not over-tighten as this could cause damage to the threaded portions.

- ✓ Remove the probe sensor guard, if it is installed.
- ✓ Remove the o-ring, if installed, from the probe module and inspect the installed o-ring on the probe module for obvious defects and, if necessary, replace it with the extra o-ring supplied.
- ✓ Some calibrations can be accomplished with the probe module upright or upside down. A separate clamp and stand, such as a ring stand, is required to support the probe module in the upside down position.
- ✓ To calibrate, follow the procedures in the next section, Calibration Procedures. The approximate volumes of the reagents are specified below for both the upright and upside down orientations.
- ✓ When using the Transport/Calibration Cup for dissolved oxygen % saturation calibration, make certain that the vessel is vented to the atmosphere by loosening the bottom cap or cup assembly and that approximately 1/8 inch (3 cm) of water is present in the cup.

Sensor to Calibrate	Upright	Upside Down
Conductivity	55ml	55ml
pH/ORP	30ml	60ml

Table 6.1 Calibration Volumes

6.2 Calibration Procedures

6.2.1 Accessing the Calibrate Screen

1. Press the **On/off** key to display the run screen.
2. Press the **Escape** key to display the main menu screen.
3. Use the arrow keys to highlight the **Calibrate** selection.

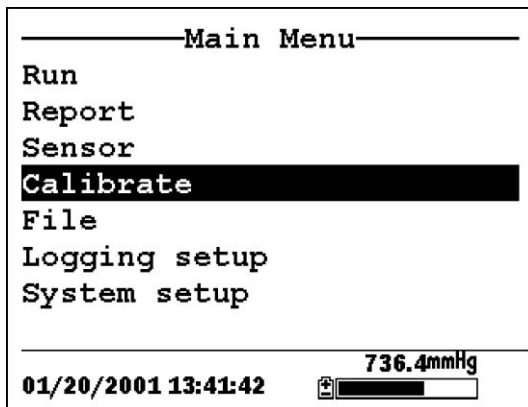

Figure 6.1 Main Menu

4. Press the **Enter** key. The Calibrate screen will be displayed.

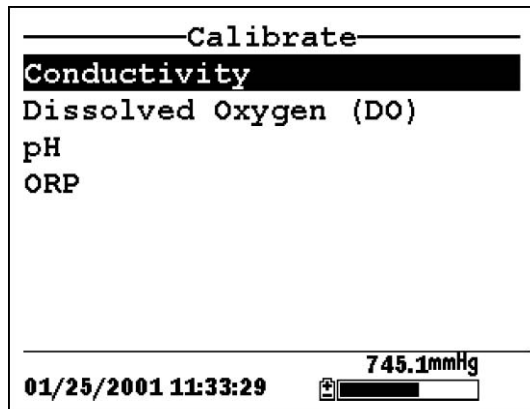

Figure 6.2 Calibrate Screen

6.2.2 Conductivity Calibration

This procedure calibrates specific conductance (recommended), conductivity and salinity. Calibrating any one option automatically calibrates the other two.

1. Go to the calibrate screen as described in Section 6.2.1 *Accessing the Calibrate Screen..*
2. Use the arrow keys to highlight the **Conductivity** selection. See Figure 6.2 Calibrate Screen.
3. Press **Enter**. The Conductivity Calibration Screen is displayed.

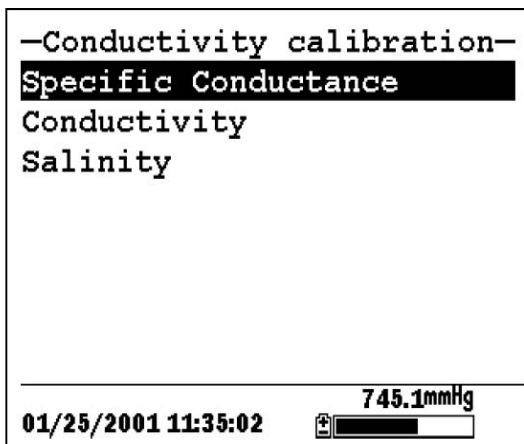

Figure 6.3 Conductivity Calibration Selection Screen

4. Use the arrow keys to highlight the Specific Conductance selection.
5. Press **Enter**. The Conductivity Calibration Entry Screen is displayed.

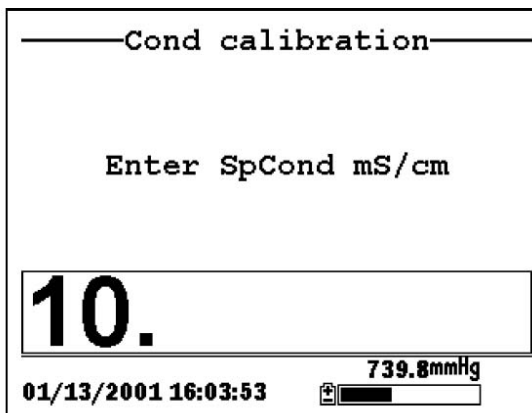



Figure 6.4 Conductivity Calibration Selection Screen

6. Place the correct amount of conductivity standard (see Table 6.1 Calibration Volumes) into a clean, dry or pre-rinsed transport/calibration cup.

 **WARNING:** Calibration reagents may be hazardous to your health. See *Appendix D Health and Safety* for more information.

NOTE: For maximum accuracy, the conductivity standard you choose should be within the same conductivity range as the samples you are preparing to measure. However, we do not recommend using standards less than 1 mS/cm. For example:

- ✓ For fresh water use a 1 mS/cm conductivity standard.
- ✓ For brackish water use a 10 mS/cm conductivity standard.
- ✓ For seawater use a 50 mS/cm conductivity standard.

NOTE: Before proceeding, ensure that the sensor is as dry as possible. Ideally, rinse the conductivity sensor with a small amount of standard that can be discarded. Be certain that you avoid cross-contamination of solutions. Make certain that there are no salt deposits around the oxygen and pH/ORP sensors, particularly if you are employing standards of low conductivity.

7. Carefully immerse the sensor end of the probe module into the solution.
8. Gently rotate and/or move the probe module up and down to remove any bubbles from the conductivity cell.

NOTE: The sensor must be completely immersed past its vent hole. Using the recommended volumes from Table 6.1 Calibration Volumes, should ensure that the vent hole is covered.

9. Screw the transport/calibration cup on the threaded end of the probe module and securely tighten.

NOTE: Do not over tighten as this could cause damage to the threaded portions.

10. Use the keypad to enter the calibration value of the standard you are using.

NOTE: Be sure to enter the value in **mS/cm at 25°C**.

11. Press **Enter**. The Conductivity Calibration Screen is displayed.

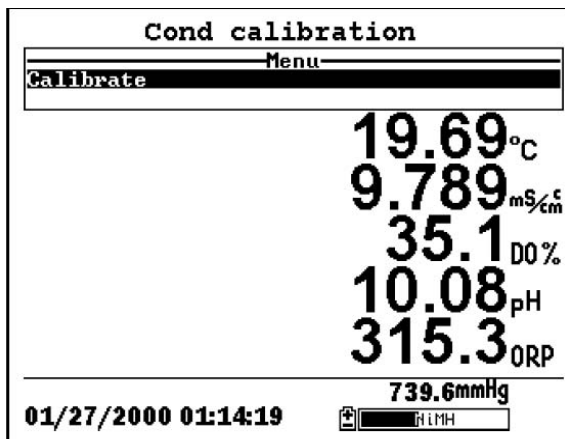

Figure 6.5 Conductivity Calibration Screen

12. Allow at least one minute for temperature equilibration before proceeding. The current values of all enabled sensors will appear on the screen and will change with time as they stabilize.
13. Observe the reading under Specific Conductance. When the reading shows no significant change for approximately 30 seconds, press **Enter**. The screen will indicate that the calibration has been accepted and prompt you to press **Enter** again to Continue.

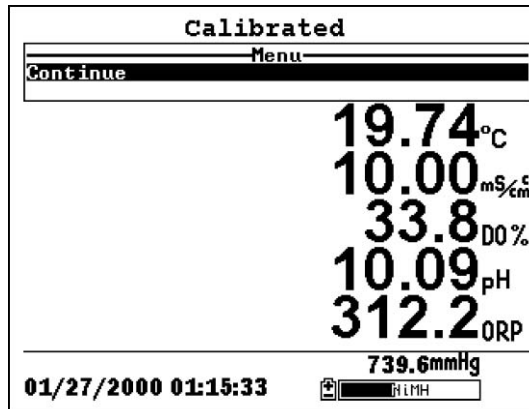

Figure 6.6 Calibrated

14. Press **Enter**. This returns you to the Conductivity Calibrate Selection Screen, See Figure 6.3 Conductivity Calibration Selection Screen..
15. Press **Escape** to return to the calibrate menu. See Figure 6.2 Calibrate Screen .
16. Rinse the probe module and sensors in tap or purified water and dry.

6.2.3 Dissolved Oxygen Calibration

This procedure calibrates dissolved oxygen. Calibrating any one option (% or mg/L) automatically calibrates the other.

1. Go to the calibrate screen as described in Section 6.2.1 *Accessing the Calibrate Screen.*

NOTE: The instrument must be on for at least 10 - 15 minutes to polarize the DO sensor before calibrating.

2. Use the arrow keys to highlight the **Dissolved Oxygen** selection. See Figure 6.2 Calibrate Screen.
3. Press **Enter**. The dissolved oxygen calibration screen is displayed.

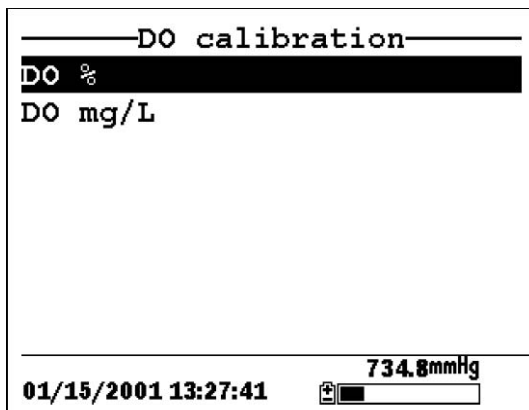

Figure 6.7 DO Calibration Screen

DO Calibration in % Saturation

1. Use the arrow keys to highlight the DO% selection.
2. Press **Enter**. The DO Barometric Pressure Entry Screen is displayed.

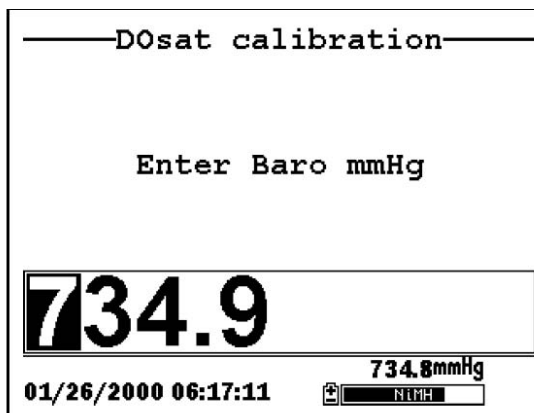

Figure 6.8 DO Barometric Pressure Entry Screen

3. Place approximately 3 mm (1/8 inch) of water in the bottom of the transport/calibration cup.
4. Place the probe module into the transport/calibration cup.

NOTE: Make sure that the DO and temperature sensors are **not** immersed in the water.

- 5. Engage only 1 or 2 threads of the transport/calibration cup to ensure the DO sensor is vented to the atmosphere.
- 6. Use the keypad to enter the current local barometric pressure.

NOTE: If the unit has the optional barometer, no entry is required.

NOTE: Barometer readings that appear in meteorological reports are generally corrected to sea level and must be uncorrected before use (refer to Section 10.10 *Calibrate Barometer, Step 2*).

- 7. Press **Enter**. The DO% saturation calibration screen is displayed.

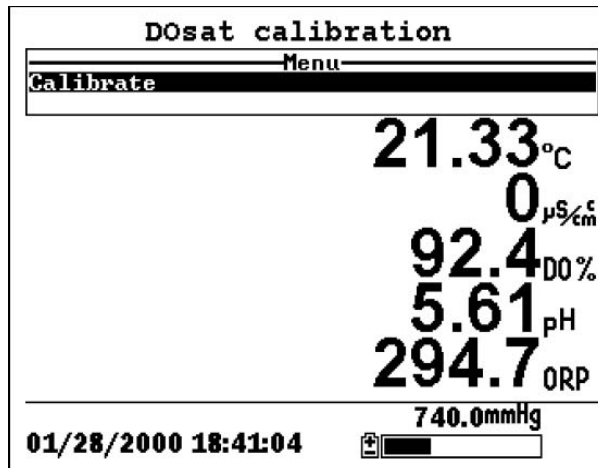

Figure 6.9 DO Sat Calibration Screen

- 8. Allow approximately ten minutes for the air in the transport/calibration cup to become water saturated and for the temperature to equilibrate before proceeding.

9. Observe the reading under DO %. When the reading shows no significant change for approximately 30 seconds, press **Enter**. The screen will indicate that the calibration has been accepted and prompt you to press **Enter** again to Continue. See Figure 6.6 Calibrated.
10. Press **Enter**. This returns you to the DO calibration screen, See Figure 6.7 DO Calibration Screen.
11. Press **Escape** to return to the calibrate menu. See Figure 6.2 Calibrate Screen.
12. Rinse the probe module and sensors in tap or purified water and dry.

DO Calibration in mg/L

DO calibration in mg/L is carried out in a water sample which has a known concentration of dissolved oxygen (usually determined by a Winkler titration).

1. Go to the DO calibrate screen as described in Section 6.2.3 *Dissolved Oxygen Calibration*, steps 1 through 3.
2. Use the arrow keys to highlight the **DO mg/L** selection.
3. Press **Enter**. The DO mg/L Entry Screen is displayed.

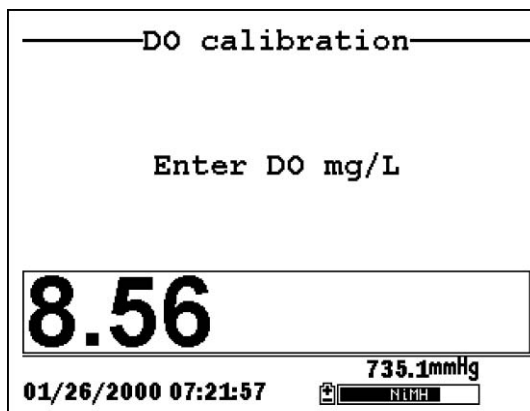

Figure 6.10 DO mg/L Entry Screen

4. Place the probe module in water with a known DO concentration.

NOTE: Be sure to completely immerse all the sensors.

5. Use the keypad to enter the known DO concentration of the water.
6. Press **Enter**. The Dissolved Oxygen mg/L Calibration Screen is displayed.

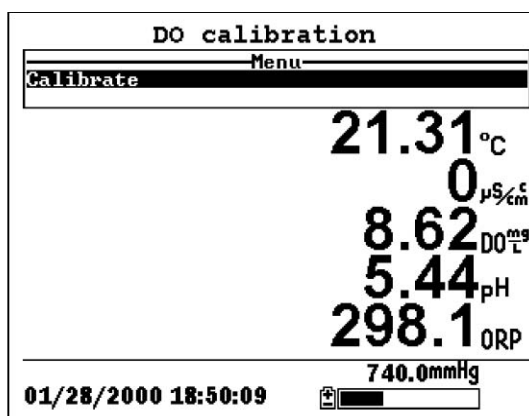

Figure 6.11 DO mg/L Calibration Screen

7. Stir the water with a stir bar, or by rapidly moving the probe module, to provide fresh sample to the DO sensor.
8. Allow at least one minute for temperature equilibration before proceeding. The current values of all enabled sensors will appear on the screen and will change with time as they stabilize.
9. Observe the DO mg/L reading, when the reading is stable (shows no significant change for approximately 30 seconds), press **Enter**. The screen will indicate that the calibration has been accepted and prompt you to press **Enter** again to Continue.
10. Press **Enter**. This returns you to the DO calibration screen. See Figure 6.7 DO Calibration Screen.
11. Press **Escape** to return to the calibrate menu. See Figure 6.2 Calibrate Screen.
12. Rinse the probe module and sensors in tap or purified water and dry.

6.2.4 pH Calibration

1. Go to the calibrate screen as described in *Section 6.2.1 Accessing the Calibrate Screen*.
2. Use the arrow keys to highlight the **pH** selection. See Figure 6.2 Calibrate Screen.
3. Press **Enter**. The pH calibration screen is displayed.

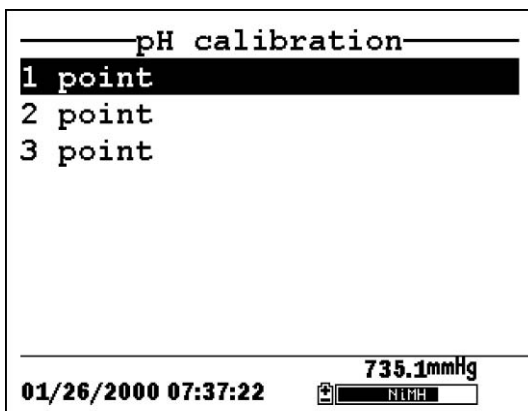

Figure 6.12 pH Calibration Screen

- Select the **1-point** option only if you are adjusting a previous calibration. If a 2-point or 3-point calibration has been performed previously, you can adjust the calibration by carrying out a one point calibration. The procedure for this calibration is the same as for a 2-point calibration, but the software will prompt you to select only one pH buffer.
 - Select the **2-point** option to calibrate the pH sensor using only two calibration standards. Use this option if the media being monitored is known to be either basic or acidic. For example, if the pH of a pond is known to vary between 5.5 and 7, a two-point calibration with pH 7 and pH 4 buffers is sufficient. A three point calibration with an additional pH 10 buffer will not increase the accuracy of this measurement since the pH is not within this higher range.
 - Select the **3-point** option to calibrate the pH sensor using three calibration solutions. In this procedure, the pH sensor is calibrated with a pH 7 buffer and two additional buffers. The 3-point calibration method assures maximum accuracy when the pH of the media to be monitored cannot be anticipated. The procedure for this calibration is the same as for a 2-point calibration, but the software will prompt you to select a third pH buffer.
- 4.** Use the arrow keys to highlight the **2-point** selection.

5. Press **Enter**. The pH Entry Screen is displayed.

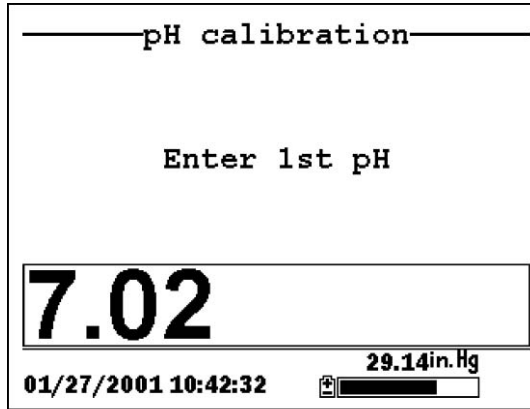

Figure 6.13 pH Entry Screen

6. Place the correct amount (see Table 6.1 Calibration Volumes) of pH buffer into a clean, dry or pre-rinsed transport/calibration cup.

NOTE: Always calibrate with buffer 7 first, regardless if performing a 1, 2, or 3 point calibration.

⚠ WARNING: Calibration reagents may be hazardous to your health. See *Appendix D Health and Safety* for more information.

NOTE: For maximum accuracy, the pH buffers you choose should be within the same pH range as the water you are preparing to sample.

NOTE: Before proceeding, ensure that the sensor is as dry as possible. Ideally, rinse the pH sensor with a small amount of buffer that can be discarded. Be certain that you avoid cross-contamination of buffers with other solutions.

7. Carefully immerse the sensor end of the probe module into the solution.
8. Gently rotate and/or move the probe module up and down to remove any bubbles from the pH sensor.

NOTE: The sensor must be completely immersed. Using the recommended volumes from Table 6.1 Calibration Volumes, should ensure that the sensor is covered.

9. Screw the transport/calibration cup on the threaded end of the probe module and securely tighten

NOTE: Do not over tighten as this could cause damage to the threaded portions.

10. Use the keypad to enter the calibration value of the buffer you are using **at the current temperature**.

NOTE: pH vs. temperature values are printed on the labels of all YSI pH buffers.

11. Press **Enter**. The pH calibration screen is displayed.

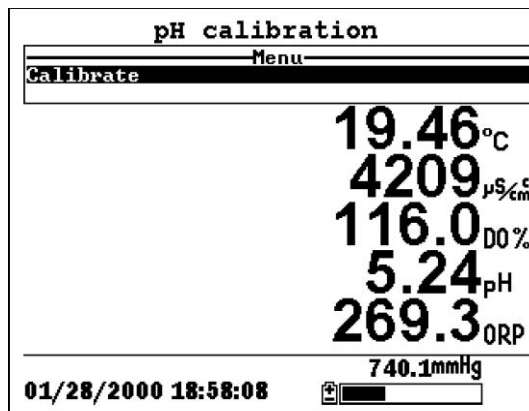

Figure 6.14 pH Calibration Screen

12. Allow at least one minute for temperature equilibration before proceeding. The current values of all enabled sensors will appear on the screen and will change with time as they stabilize.
13. Observe the reading under pH, when the reading shows no significant change for approximately 30 seconds, press **Enter**.

The screen will indicate that the calibration has been accepted and prompt you to press **Enter** again to Continue.

- 14.** Press **Enter**. This returns you to the specified pH Calibration Screen, See Figure 6.13 pH Entry Screen.
- 15.** Rinse the probe module, transport/calibration cup and sensors in tap or purified water and dry.
- 16.** Repeat steps 6 through 13 above using a second pH buffer.
- 17.** Press **Enter**. This returns you to the pH Calibration Screen, See Figure 6.12 pH Calibration Screen.
- 18.** Press **Escape** to return to the calibrate menu. See Figure 6.2 Calibrate Screen.
- 19.** Rinse the probe module and sensors in tap or purified water and dry.

6.2.5 ORP Calibration

- 1.** Go to the calibrate screen as described in Section 6.2.1 *Accessing the Calibrate Screen*.
- 2.** Use the arrow keys to highlight the **ORP** selection. See Figure 6.2 Calibrate Screen..
- 3.** Press **Enter**. The ORP calibration screen is displayed.

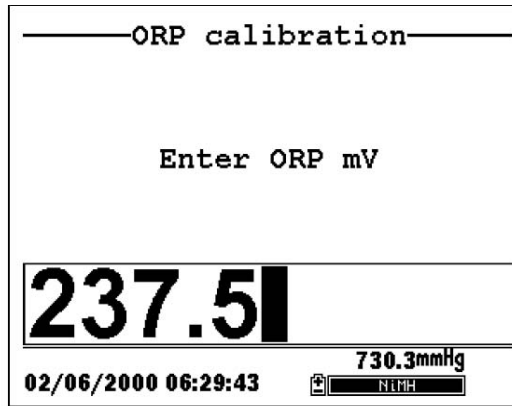

Figure 6.15 Specified ORP Calibration Screen

4. Place the correct amount (see Table 6.1 Calibration Volumes) of a known ORP solution (we recommend Zobell solution) into a clean, dry or pre-rinsed transport/calibration cup.

⚠ WARNING: Calibration reagents may be hazardous to your health. See *Appendix D Health and Safety* for more information.

NOTE: Before proceeding, ensure that the sensor is as dry as possible. Ideally, rinse the ORP sensor with a small amount of solution that can be discarded. Be certain that you avoid cross-contamination with other solutions.

5. Carefully immerse the sensor end of the probe module into the solution.
6. Gently rotate and/or move the probe module up and down to remove any bubbles from the ORP sensor.

NOTE: The sensor must be completely immersed. Using the recommended volumes from Table 6.1 Calibration Volumes should ensure that the sensor is covered.

7. Screw the transport/calibration cup on the threaded end of the probe module and securely tighten.

NOTE: Do not over tighten as this could cause damage to the threaded portions.

8. Use the keypad to enter the correct value of the calibration solution you are using at the current temperature. Refer to Table 6.2 Zobell Solution Values.

Temperature °C	Zobell Solution Value, mV
-5	270.0
0	263.5
5	257.0
10	250.5
15	244.0
20	237.5
25	231.0
30	224.5
35	218.0
40	211.5
45	205.0
50	198.5

Table 6.2 Zobell Solution Values

9. Press **Enter**. The ORP calibration screen is displayed.

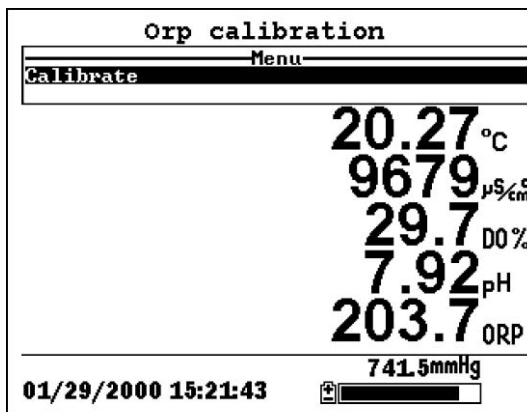

Figure 6.16 DO Cal Screen

10. Allow at least one minute for temperature equilibration before proceeding. The current values of all enabled sensors will appear on the screen and will change with time as they stabilize.

NOTE: Verify that the temperature reading matches the value you used in Table 6.2 Zobell Solution Values.

11. Observe the reading under ORP, when the reading shows no significant change for approximately 30 seconds, press **Enter**. The screen will indicate that the calibration has been accepted and prompt you to press **Enter** again to Continue.
12. Press **Enter**. This returns you to the Calibrate Screen. See Figure 6.2 Calibrate Screen.
13. Rinse the probe module and sensors in tap or purified water and dry.

6.3 Return to Factory Settings.

1. Go to the calibrate screen as described in Section 6.2.1 *Accessing the Calibrate Screen*.
2. Use the arrow keys to highlight the **Conductivity** selection. See Figure 6.2 Calibrate Screen.

NOTE: We will use the Conductivity sensor as an example; however, this process will work for any sensor.

3. Press **Enter**. The Conductivity Calibration Selection Screen is displayed. See Figure 6.3 Conductivity Calibration Selection Screen.
4. Use the arrow keys to highlight the **Specific Conductance** selection.
5. Press **Enter**. The Conductivity Calibration Entry Screen is displayed. See Figure 6.4 Conductivity Calibration Entry Screen.
6. Press and hold the **Enter** key down and press the **Escape** key.

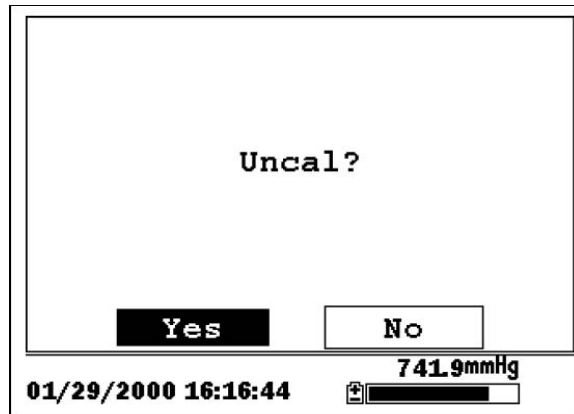

Figure 6.17 ORP Calibration Screen

7. Use the arrow keys to highlight the **YES** selection.

CAUTION: This returns a sensor to the factory settings. For example, in selecting to return specific conductance to the factory setting, salinity and conductivity will automatically return to their factory settings.

8. Press **Enter**. This returns you to the Conductivity Calibrate Selection Screen, See Figure 6.3 Conductivity Calibration Selection Screen. .
9. Press **Escape** to return to the calibrate menu. See Figure 6.2 Calibrate Screen.

7. Run

The Run screen displays data from the sensors in real-time and allows the user to log sample data to memory for later analysis. Refer to Section 9 *Logging* for details on logging sample data.

7.1 Real-Time Data

NOTE: Before measuring samples you must prepare the probe module (refer to Section 3.4 *Preparing the Probe Module*), attach the probe module to the instrument (refer to Section 3.6 *Instrument/Cable Connection*) and calibrate the sensors (refer to Section 6 *Calibrate*).

1. Press the On/off key.

OR select Run from the main menu to display the run screen.

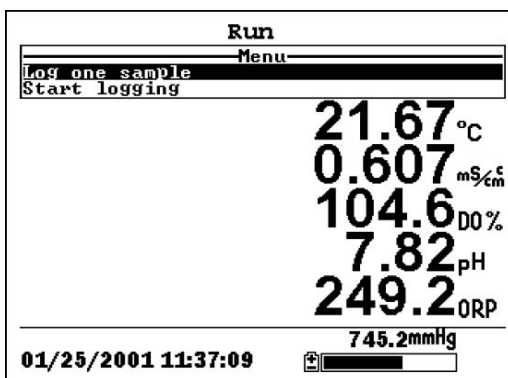

Figure 7.1 Run Screen

2. Make sure the probe sensor guard is installed.
3. Place the probe module in the sample. Be sure to completely immerse all the sensors.
4. Rapidly move the probe module through the sample to provide fresh sample to the DO sensor.
5. Watch the readings on the display until they are stable.
6. Refer to Section 9 *Logging* for instructions on logging sample data.

8. File

The File menu allows the user to view, upload or delete sample data and calibration record files stored in the YSI 556 MPS.

8.1 Accessing the File Screen

1. Press the **On/off** key to display the run screen.
2. Press the **Escape** key to display the main menu screen.

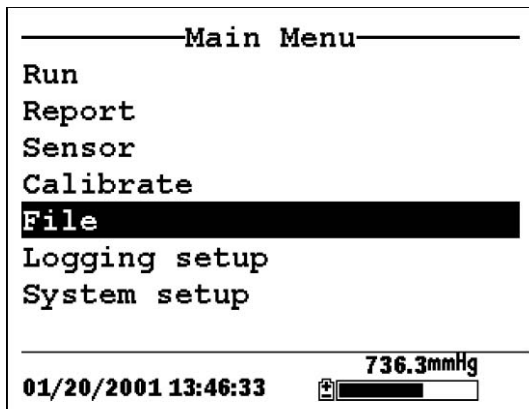

Figure 8.1 Main Menu Screen

3. Use the arrow keys to highlight the **File** selection.
4. Press the **Enter** key. The file screen is displayed.



Figure 8.2 File Screen

8.2 Directory

1. Go to the file screen as described in Section 8.1 *Accessing the File Screen*.
2. Use the arrow keys to highlight the **Directory** selection. See Figure 8.2 File Screen.
3. Press the **Enter** key. The file list screen is displayed.

NOTE: Files are listed in the order in which they are logged to memory. Sample Data files have the file extension **.dat**, while Calibration Record files have the file extension **.glp**.

Filename	Samples	Bytes
RED.dat	26	955
CAT.dat	63	2028
OHIO.dat	118	3623
00008004.glp	6	130

01/20/2001 13:57:40 736.8mmHg

Figure 8.3 File List Screen

4. Use the arrow keys to highlight a file.
5. Press the **Enter** key. The file details screen is displayed.

File details	
View file	
File:OHIO.dat	
Site:	
ID:	
Samples:	118
Bytes:	3623
First:	01/20/2001 13:56:13
Last :	01/20/2001 13:57:11

01/20/2001 13:58:50 736.8mmHg

Figure 8.4 File Details Screen

6. Press the **Enter** key to view the file data. Refer to Section 8.3 *View File* for details.
7. Press the **Escape** key repeatedly to return to the main menu screen.

8.3 View File

1. Go to the file screen as described in Section 8.1 *Accessing the File Screen*. See Figure 8.2 File Screen.
2. Use the arrow keys to highlight the **View file** selection.
3. Press the **Enter** key. A list of files is displayed. See Figure 8.3 File List Screen.
4. Use the arrow keys to highlight an individual file.

NOTE: You may have to scroll down to see all the files.

5. Press the **Enter** key. The file data is displayed with the file name at the top of the display.

NOTE: If no file name was specified, the data is stored under the default name NONAME1.dat.

OHIO.dat		
Date	Time	Temp
m/d/y	hh:mm:ss	C
01/20/2001	13:56:13	22.54
01/20/2001	13:56:13	22.54
01/20/2001	13:56:14	22.54
01/20/2001	13:56:14	22.54
01/20/2001	13:56:15	22.54
01/20/2001	13:56:15	22.54
01/20/2001	13:56:16	22.54
01/20/2001	13:56:16	22.54
01/20/2001	13:56:17	22.54

736.7mmHg	
01/20/2001 13:59:34	

Figure 8.5 File Data Screen

6. Use the arrow keys to scroll horizontally and/or vertically to view all the data.
7. Press the **Escape** key repeatedly to return to the main menu screen.

8.4 Upload to PC

EcoWatch™ for Windows™ must be used as the PC software interface to the YSI 556 MPS. Refer to *Appendix G EcoWatch* for more information. EcoWatch for Windows® is available at no cost via a download from the YSI Web Site (www.ysi.com) or by contacting YSI Customer Support. Refer to *Appendix E Customer Service*.

8.4.1 Upload Setup

1. Disconnect the YSI 5563 Probe Module from the YSI 556 MPS instrument.
2. Connect the YSI 556 MPS to a serial (Comm) port of your computer via the 655173 PC Interface cable as shown in the following diagram:

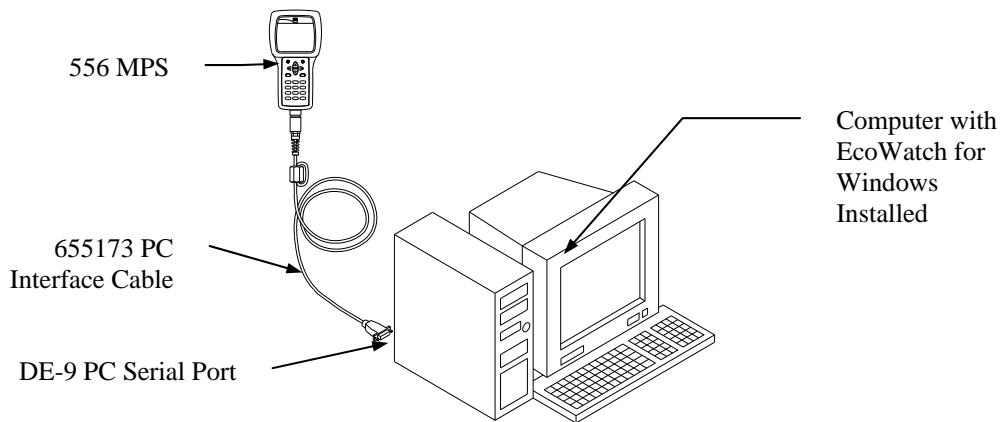



Figure 8.2 Computer/Instrument Interface

3. Open EcoWatch for Windows on your computer.

NOTE: See *Appendix G EcoWatch* for installation instructions.

4. Click on the sonde/probe icon  in the upper toolbar.

5. Set the Comm port number to match the port the YSI 556 MPS is connected to. After this setup procedure, the following screen will be present on your PC monitor:

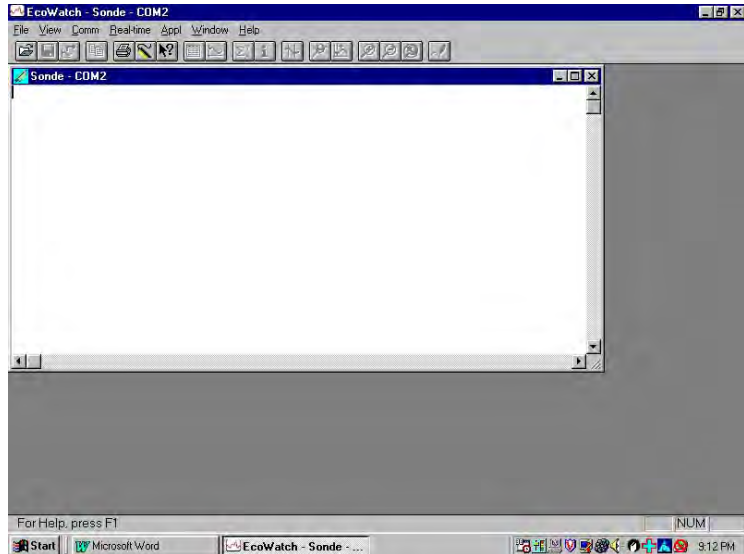

8.4.2 Uploading a .DAT File

1. Setup the instrument as described in Section 8.4.1 *Upload Setup*.
2. Go to the YSI 556 MPS file screen as described in Section 8.1 *Accessing the File Screen*.
3. Use the arrow keys to highlight the **Upload to PC** selection. See Figure 8.2 File Screen.
4. Press the **Enter** key. The file list screen is displayed. See Figure 8.3 File List Screen.
5. Use the arrow keys to highlight the DAT file that you wish to transfer and press **Enter**, both the YSI 556 MPS and PC displays show the progress of the file transfer.

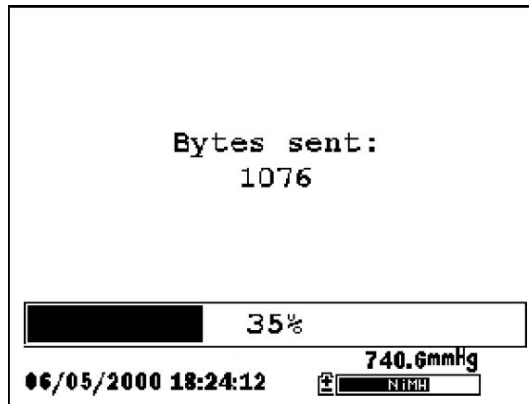
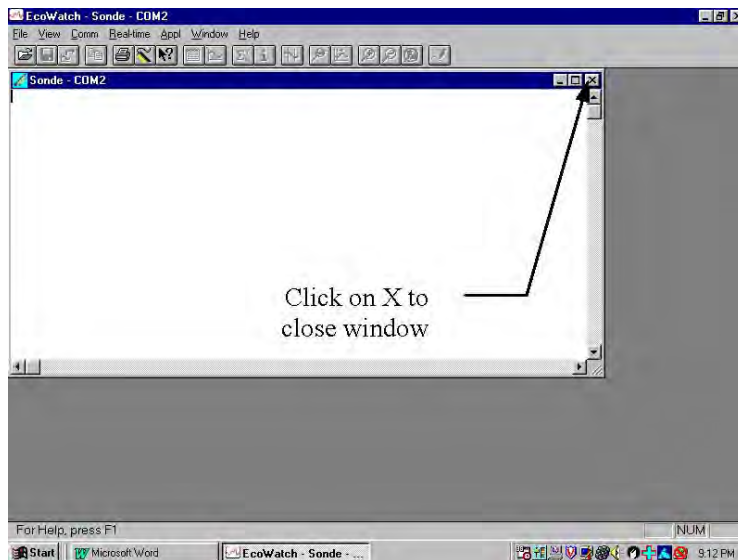

Figure 8.3 File Transfer Progress Screen

NOTE: After transfer, the file will be located in the C:\ECOWWIN\DATA folder of your PC, designated with a .DAT extension.

- 6. After the file transfer is complete, close the terminal window (small window on the PC) by clicking on the “X” at its upper right corner.



- 7. Press the **Escape** key on the YSI 556 MPS repeatedly to return

to the main menu screen.

8.4.3 Uploading a Calibration Record (.glp) File

For more information on the calibration record, refer to *Appendix H Calibration Record Information*.

1. Setup up the instrument as described in Section 8.4.1 *Upload Setup*.
2. Go to the YSI 556 MPS file screen as described in Section
3. Use the arrow keys to highlight the Upload to PC selection. See Figure 8.2 File Screen.
4. Press the **Enter** key. The file list screen is displayed. See Figure 8.3 File List Screen.
5. Use the arrow keys to highlight the calibration record file that you wish to transfer and press **Enter**.
6. You will then be given a choice of uploading the file in three formats; **Binary, Comma & “” Delimited, and ASCII Text**.

NOTE: The binary format is reserved for future YSI software packages.

7. Choose an option and press Enter, both the YSI 556 and PC displays show the progress of the file transfer.

NOTE: After transfer, the file will be located in the C:\ECOWWIN\DATA folder of your PC, designated with the appropriate file extension.

NOTE: To view the Calibration Record data after upload, simply open the .txt file in a general text editor such as Wordpad or Notepad.

8. After the file transfer is complete, close the terminal window (small window on the PC) by clicking on the “X” at its upper right corner.

9. Press the **Escape** key repeatedly to return to the main menu screen.

8.5 File Memory

1. Go to the file screen as described in Section 8.1 *Accessing the File Screen*.
2. Use the arrow keys to highlight the **File memory** selection. See Figure 8.2 File Screen.
3. Press the **Enter** key. The file bytes used screen is displayed.

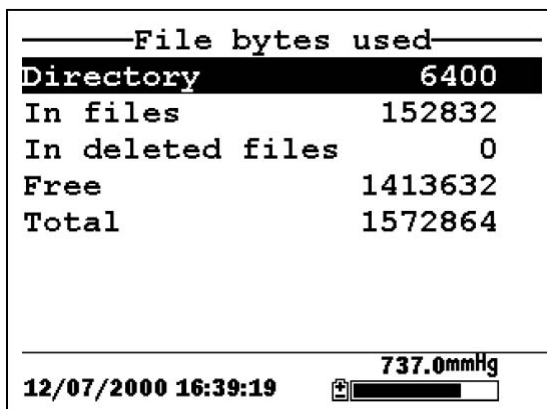

The screenshot shows a terminal window titled "File bytes used". The content is as follows:

File bytes used	
Directory	6400
In files	152832
In deleted files	0
Free	1413632
Total	1572864

At the bottom of the screen, there is a status bar containing the date and time "12/07/2000 16:39:19", a battery level indicator showing "737.0mmHg", and a small icon.

Figure 8.4 File Bytes Used Screen

4. The amount of free memory is listed in line 4 of the file bytes used screen.

NOTE: If the amount of free memory is low, it may be time to delete all files (after first uploading all data to a PC). Refer to Section 8.6 *Delete All Files*.

5. Press the **Escape** key repeatedly to return to the main menu screen.

8.6 Delete All Files

NOTE: It is not possible to delete individual files in order to free up memory. The only way to free up memory is to delete ALL files present. Take care to transfer all files to your computer (refer to Section 8.4 Upload to PC) before deleting them.

1. Go to the file screen as described in Section 8.1 *Accessing the File Screen*.
2. Use the arrow keys to highlight the **Delete all files** selection. See Figure 8.2 File Screen.
3. Press the **Enter** key. The Delete all Files screen is displayed.

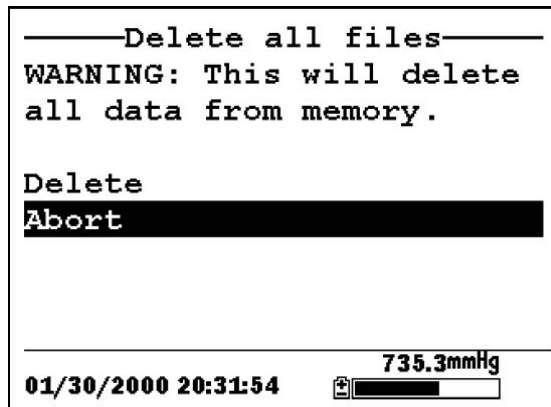

Figure 8.5 Delete All Files Screen

4. Use the arrow keys to highlight the **Delete** selection.
5. Press the **Enter** key.

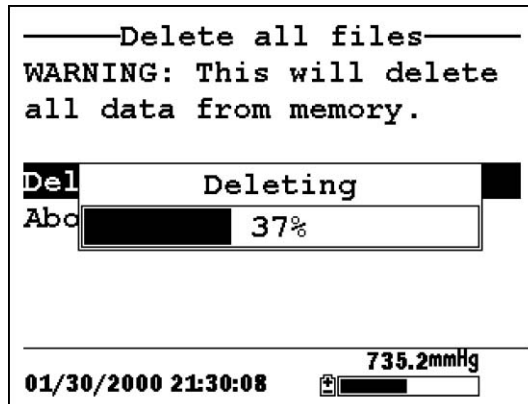

Figure 8.10 Deleting

The progress of file deletion is displayed in bar graph format.

NOTE: Deleting all files in the directory will not change any information in the site list.

6. Press the Escape key repeatedly to return to the main menu screen.

9. Logging

9.1 Accessing the Logging Setup Screen

1. Press the **On/off** key to display the run screen.
2. Press the **Escape** key to display the main menu screen.

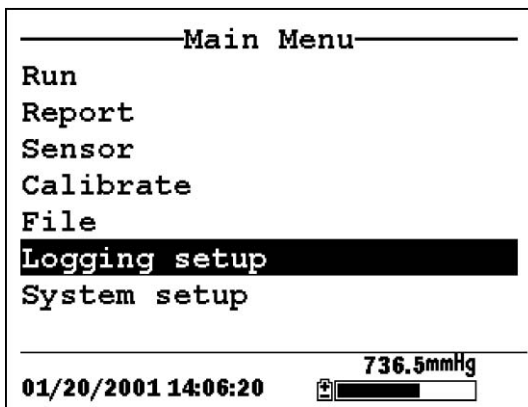

Figure 9.1 Main Menu

3. Use the arrow keys to highlight the **Logging setup** selection.
4. Press the **Enter** key. The logging setup screen is displayed.

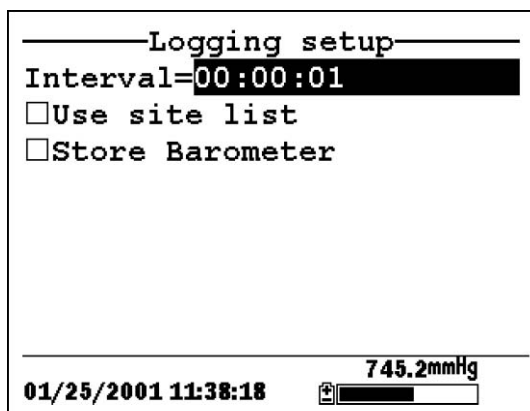

Figure 9.2 Setup Screen

9.2 Setting Logging Interval

Follow steps below to set the interval for logging a data stream.

NOTE: If you do not specify an interval, the instrument will use a default interval setting of 1 second.

NOTE: It is not necessary to set a logging interval when logging a single sample.

1. Go to the logging setup screen as described in Section 9.1 *Accessing the Logging Setup Screen*.
2. Use the keypad to enter an interval between 1 second and 15 minutes. Refer to Section 2.9 *Keypad Use*.

NOTE: The interval field has hour, minute and second entry fields. Any entry over 1 hour will change automatically to a 15-minute setting.

3. Press the **Enter** key. The data stream interval is set.
4. Press the **Escape** key repeatedly to return to the main menu screen.

9.3 Storing Barometer Readings

NOTE: The **Store barometer** option is only available on instruments that are equipped with the optional barometer.

1. Go to the logging setup screen as described in Section 9.1 *Accessing the Logging Setup Screen*.
2. Use the arrow keys to highlight the **Store barometer** selection. See Figure 9.2 Logging Setup Screen.
3. Press the **Enter** key until a check mark is entered in the box next to the store barometer selection if you want to log barometric readings.

OR press the **Enter** key until the box next to the barometer selection is empty if you do not want to log barometric readings.

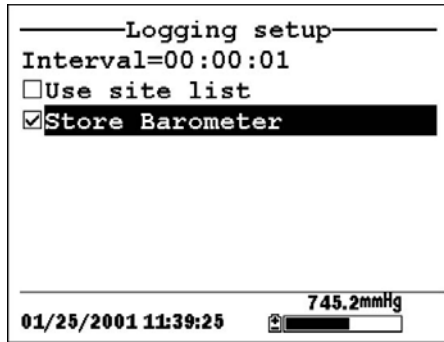

Figure 9.3 Store Barometer

4. Press the **Escape** key repeatedly to return to the main menu screen.

9.4 Creating a Site List

The site list option allows you to define file and site descriptions in the office or laboratory before moving to field logging studies. This is usually more convenient than entering the information at the site and is particularly valuable if you are visiting certain sites on a regular basis. The following section describes how to set up site lists which contain entries designated “Site Descriptions” that will be instantly available to the user in the field to facilitate the logging of data with pre-established naming of files and sites. There are two kinds of **Site Descriptions** available for use in Site lists:

- **Site Descriptions** associated with applications where data from a single site is always logged to a single file. This type is referred to as a “Single-Site Description” and is characterized by two parameters – a file name and a site name. Files logged to YSI 556 MPS memory under a **Single-Site Description** will be characterized primarily by the file name, but will also have the Site name attached, so that it is viewable in either the YSI 556 MPS **File directory** or in EcoWatch for Windows after upload to a PC
- **Site Descriptions** associated with applications where data from multiple sites are logged to a single file. This type is referred to as a “Multi-site Description” and is characterized by three parameters – a file name, a site name, and a site number. Files logged to YSI 556 MPS memory under a

Multi-site Description are characterized by a file name, but not a site name, since multiple sites are involved. However, each data point has a Site Number attached to it so that the user can easily determine the sampling site when viewing the data from the YSI 556 MPS **File** menu or processing the data in EcoWatch for Windows after upload to a PC.

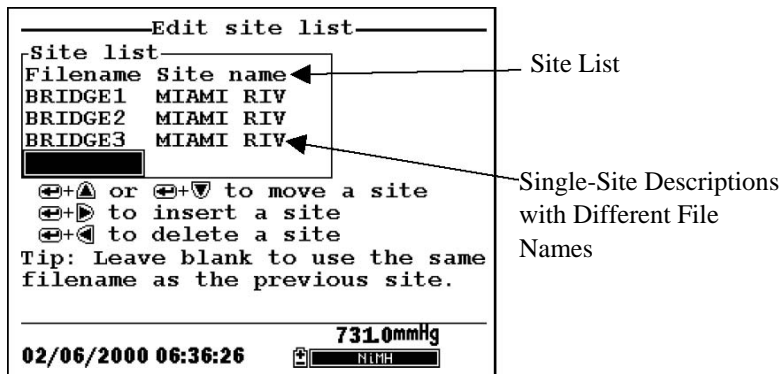

Figure 9.4 Single-Site Descriptions



Figure 9.5 Multiple-Site Descriptions

NOTE: Site lists containing Single Site Descriptions are usually input with the designation **Store Site Number** INACTIVE in the YSI 556 MPS **Logging setup** menu. Thus, no site numbers appear in the first **Site list** example. Conversely, **Site lists** containing **Multi-Site Descriptions** MUST be input with the **Store Site Number** selection ACTIVE as shown in the second example.

To create a site list:

1. Go to the logging setup screen as described in Section 9.1 *Accessing the Logging Setup Screen*.
2. Use the arrow keys to highlight the **Use site list** selection.
3. Press the **Enter** key. A check mark is entered in the box next to the use site list selection *and* two new entries appear on the logging setup screen. See Figure 9.6 Logging Setup Screen.

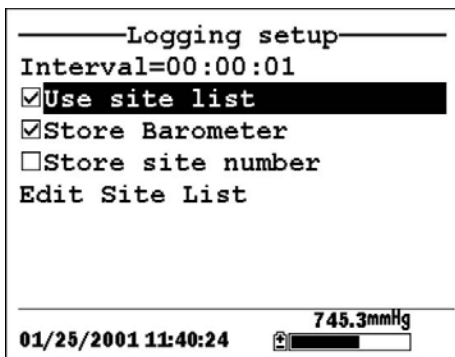

Figure 9.6 Logging Setup Screen

4. Use the arrow keys to highlight the **Store site number** selection.
5. If you are creating Multi-Site Descriptions (which require that the site **number** be stored in your data files), press the **Enter** key until a check mark appears in the box next to the store site number selection.

OR Press the **Enter** key until the box next to the store site number selection is empty, to create Single-Site Descriptions. The site **name** will be stored in the header of your data files.

6. Use the arrow keys to highlight the **Edit site list** selection.
7. Press the **Enter** key. The edit site list screen is displayed. See Figure 9.7 Edit Site List Screen. The **Filename** field is ready for input.

Edit site list		
Site list		
Filename	Site name	Site Num
<input type="text"/>		0
⬅+▲ or ➡+▼ to move a site ⬅+▶ to insert a site ➡+◀ to delete a site Tip: Leave blank to use the same filename as the previous site.		
		745.3mmHg
01/25/2001 11:42:21	<input type="text"/>	

Figure 9.7 Edit Site List Screen

8. Use the keypad to enter a filename up to 8 characters in length. Refer to Section 2.9 *Keypad Use*.
9. Press the **Enter** key. The cursor moves to the right for the entry of a **Site name**.
10. Use the keypad to enter a site name up to 11 characters in length. Refer to Section 2.9 *Keypad Use*.

NOTE: If the store site number selection is *not* checked, skip to Step 13.
11. Press the **Enter** key. The cursor moves to the site number entry position.
12. Use the keypad to enter a site number up to 7 characters in length. Refer to Section 2.9 *Keypad Use*.
13. Press **Enter**. The cursor moves to the next filename entry position.
14. Repeat Steps 8 to 13 until all filenames and sites have been entered.
15. Press **Escape** repeatedly to return to the main menu screen.

9.5 Editing a Site List

1. Go to the logging setup screen as described in Section 9.1 *Accessing the Logging Setup Screen*.
2. Use the arrow keys to highlight the **Edit Site List** selection. See Figure 9.6 Logging Setup Screen.
3. Press the **Enter** key. The edit site list screen is displayed.
4. Edit the site list using the keystrokes described below.

NOTE: Editing the site list will not have any effect on files stored in the instrument memory.

To MOVE a site:

Use the arrow keys to highlight a site. Press the Up or Down arrow key while holding down the Enter key.

To INSERT a site above another site:

Use the arrow keys to highlight the site. Press the Right arrow key while holding down the Enter key. Use keypad to input letters. Refer to Section 2.9 *Keypad Use*.

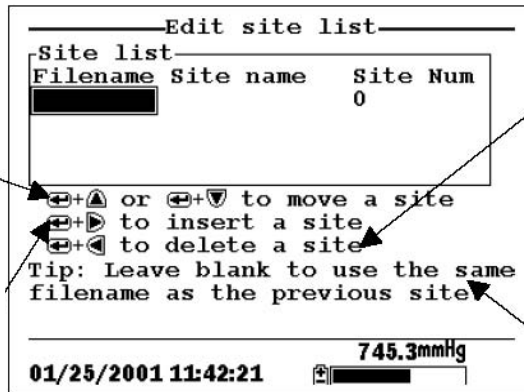

To DELETE a site:

Use the arrow keys to highlight a site. Press the Left arrow key while holding down the Enter key.

To use the same file name as the previous site: Leave the filename blank

Figure 9.1 Keystrokes for Editing Site List

9.6 Logging Data Without a Site List

1. Follow Steps 1 through 5 in Section 7.1 Real-Time Data.
2. Use the arrow keys to highlight the **Log one sample** selection on the run screen if only a single sample is being logged.

OR Use the arrow keys to highlight the **Start logging** selection on the run screen if a data stream is being logged.

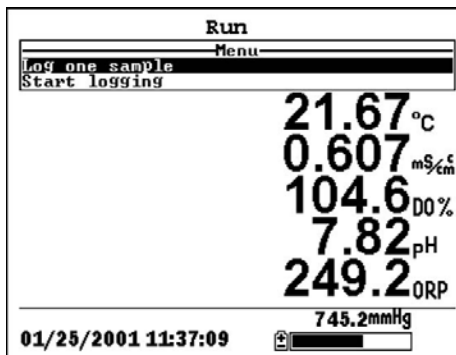

Figure 9.9 Run Screen

3. Press the **Enter** key. The Enter information screen is displayed.

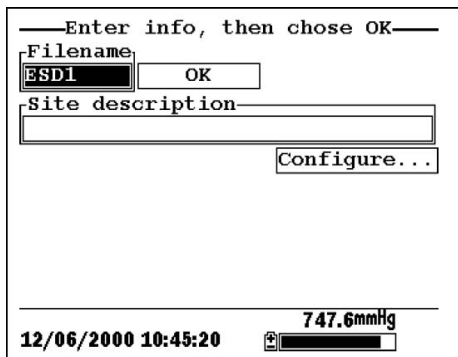

Figure 9.10 Enter Information Screen

NOTE: The last filename used will be displayed.

4. Use the keypad to enter a file name. Refer to Section 2.9 *Keypad Use*.

NOTE: The instrument will assign a default file name of NONAME if no file name is specified.

5. Press the **Enter** key to input the file name.

6. Use the arrow keys to highlight the **Site description** field in the enter information screen.

NOTE: Entering a Site Description is optional. You may leave the Site Description blank and skip to Step 9.

7. Use the keypad to enter a site description name. Refer to Section 2.9 *Keypad Use*.

8. Press the **Enter** key to input the site description.

NOTE: If you want to change the logging setup, such as sampling interval or storing the barometer reading, use the arrow keys to highlight the **Configure** field, press the **Enter** key, then refer to Section 9.2 *Setting Logging Interval* or 9.3 *Storing Barometer Readings* for details.

9. Use the arrow keys to highlight the **OK** field in the center of the information screen.

10. Press the **Enter** key to start logging.

NOTE: If the parameter mismatch screen is displayed, refer to Section 9.8 *Adding Data to Existing Files*.

11. If a single point is being logged, the header on the run screen changes momentarily from **Menu** to **Sample logged** to confirm that the point was successfully logged. Skip to Step

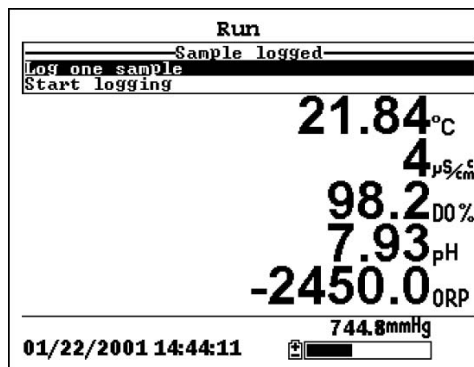

Figure 9.11 Sample Logged Screen

If a continuous stream of points is being logged, the start logging entry in the run screen changes from **Start logging** to **Stop logging**.

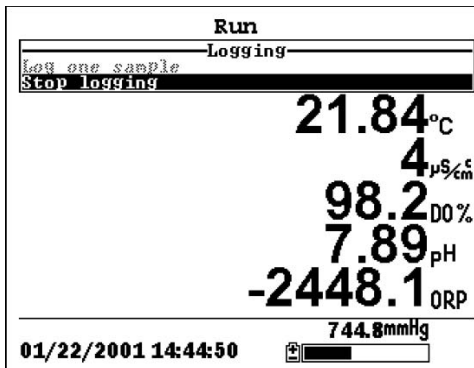

Figure 9.12 Logging Screen

12. At the end of the logging interval, press **Enter** to stop logging.
13. Refer to Section 8.3 *View File* to view the data on the instrument display.

9.7 Logging Data with a Site List

1. If you have not already created a site list, refer to Section 9.4 *Creating a Site List*.
2. Follow Steps 1 through 5 in Section 7.1 Real-Time Data.
3. Use the arrow keys to highlight the **Log one sample** selection on the run screen if only a single sample is being logged.

OR Use the arrow keys to highlight the **Start logging** selection on the run screen if a data stream is being logged. See Figure 9.9 Run Screen.
4. Press the **Enter** key. The Pick a site screen is displayed.

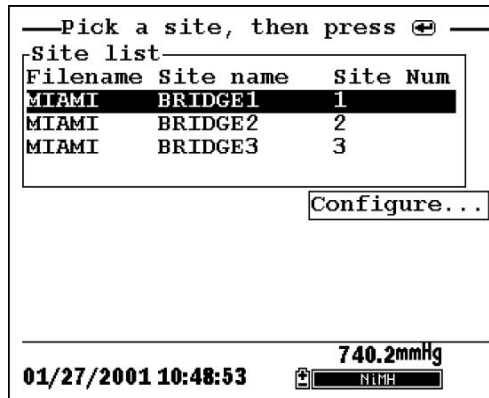

Figure 9.13 Pick a Site Screen

5. Use the arrow keys to highlight the **site** of your choice.

NOTE: If the site of your choice is grayed out in the site list, refer to Section 9.8 *Adding Data to Existing Files*.

NOTE: Refer to Section 9.5 *Editing a Site List* if you want to edit the site list.

6. Press the **Enter** key to start logging.

NOTE: If the parameter mismatch screen is displayed, refer to Section 9.8 *Adding Data to Existing Files*.

7. If a single point is being logged, the header on the run screen changes momentarily from **Menu** to **Sample logged** to confirm that the point was successfully logged. See Figure 9.11 *Sample Logged Screen*. Skip to Step 9.

If a continuous stream of points is being logged, the start logging entry in the run screen changes from **Start logging** to **Stop logging**. See Figure 9.12 *Logging Screen*.

8. At the end of the logging interval, press **Enter** to stop logging.

9. Refer to Section 8.3 *View File* to view the data on the instrument display.

9.8 Adding Data to Existing Files

In order to add new data to an existing file, the current logging and sensor setup must be *exactly* the same as when the file was created. The following settings must be the same:

- **Sensors enabled** (refer to Section 4 *Sensors*)
- **Store Barometer** (refer to Section 9.3 *Storing Barometer Readings*)
- **Store Site Number** (refer to Section 9.4 *Creating a Site List*)

If the current logging setup is not exactly the same as when the file was created, a parameter mismatch screen is displayed.

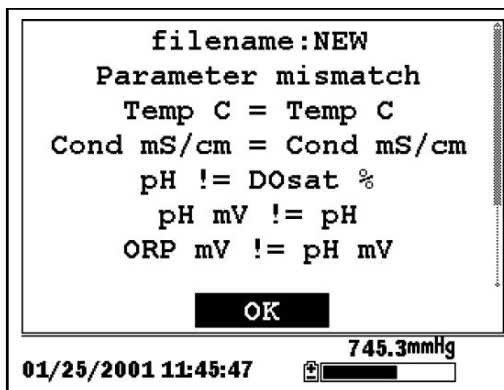

Figure 9.14 Parameter Mismatch Screen

NOTE: The right column shows parameters used when the file was created. The left column shows current parameters.

1. Press the **Down Arrow** key to scroll down and find the mismatch(es).
2. Use the following chart to resolve the mismatch(es).

Mismatch	Action	Reference
Sensor(s) missing from left column	Enable the missing sensor(s)	Section 4 <i>Sensors</i>
Extra sensor(s) listed in left column	Disable the extra sensor(s)	Section 4 <i>Sensors</i>
Barometer missing from left column, but present in right column	Enable the Store Barometer setting	Section 9.3 <i>Storing Barometer Readings</i>
Barometer present in left column, but missing from right column	Disable the Store Barometer setting	Section 9.3 <i>Storing Barometer Readings</i>
Store Site Number missing from left column, but present in right column	Enable the Store Site Number setting	Section 9.4 <i>Creating a Site List</i>
Store Site Number present in left column, but missing from right column	Disable the Store Site Number setting	Section 9.4 <i>Creating a Site List</i>

- 3.** Return to Section 9.6 *Logging Data without a Site List* or 9.7 *Logging Data with a Site List*.

10. System Setup

The YSI 556 MPS has a number of features that are user-selectable or can be configured to meet the user's preferences. Most of these choices are found in the **System setup** menu.

10.1 Accessing the System Setup Screen

1. Press the **On/off** key to display the run screen. See Figure Front View of YSI 556 MPS.
2. Press the **Escape** key to display the main menu screen.
3. Use the arrow keys to highlight the **System setup** selection.

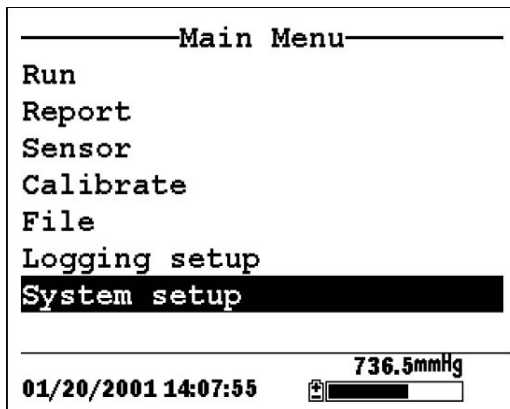

Figure 10.1 Main Menu

4. Press the **Enter** key. The system setup screen is displayed.

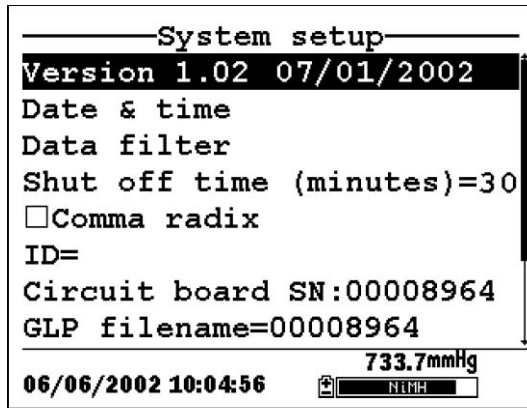

Figure 10.2 System Setup Screen

NOTE: The first line of the **System setup** menu shows the current software version of your YSI 556 MPS. As software enhancements are introduced, you will be able to upgrade your YSI 556 MPS from the YSI Web site. Refer to Section 11.2 *Upgrading YSI 556 MPS Software* for details.

10.2 Language Setting

1. Go to the System Setup screen as described in Section 10.1 *Accessing the System Setup Screen*.
2. Use the arrow keys to highlight **Language** on the System Setup screen. Press **Enter** to open the Language screen. .
3. Use the arrow keys to highlight your desired **Language**. Press **Enter**.
4. Press the Escape key repeatedly to return to the Main men

10.3 Date and Time Setup

1. Go to the system setup screen as described in Section 10.1 *Accessing the System Setup Screen*.

2. Use the arrow keys to highlight the **Date & time** selection on the system setup screen. See Figure 10.2 System Setup Screen.
3. Press **Enter**. The date and time setup screen is displayed.

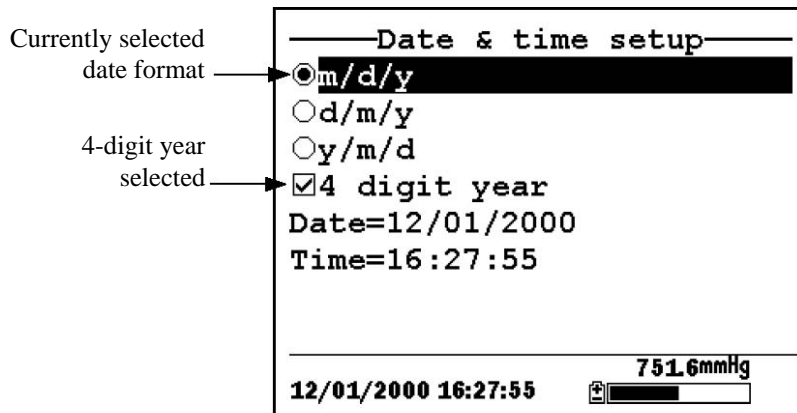

Figure 10.3 Date Setup Screen

NOTE: A black dot to the left of a date format indicates that format is selected.

4. Use the arrow keys to highlight your desired date format.
5. Press **Enter**.
6. Use the arrow keys to highlight the 4-digit year selection.
7. Press **Enter**. A check mark appears in the check box next to the 4-digit year selection.

NOTE: If unchecked, a 2-digit year is used.

8. Use the arrow keys to highlight the **Date** selection.
9. Press **Enter**. A cursor appears over the first number in the date.

10. Enter the proper number from the keypad for the highlighted date digit. The cursor moves automatically to the next date digit. Refer to Section 2.9 *Keypad Use* for more keypad information.
11. Repeat Step 10 until all date digits are correct.
12. Press **Enter** to input the specified date.
13. Use the arrow keys to highlight the **Time** selection.
14. Press **Enter**. A cursor appears over the first number in the time selection.
15. Enter the proper number from the keypad for the highlighted time digit. The cursor moves automatically to the next time digit.

NOTE: Use military format when entering time. For example, 2:00 PM is entered as 14:00.
16. Repeat Step 15 until all time digits are correct.
17. Press **Enter** to input the correct time.
18. Press the **Escape** key repeatedly to return to the Main menu screen.

10.4 Data Filter

The Data Filter is a software filter that eliminates sensor noise and provides more stable readings.

NOTE: YSI recommends using the default values for the data filter for most field applications.

However, users who are primarily interested in a fast response from their dissolved oxygen sensor should consider a change of the default time constant setting of 8 seconds to one of 2 seconds. This change can be made according to the instructions in Section 10.3.1 *Changing the Data Filter Settings* below. The disadvantage of lowering the time constant is that field pH readings may appear somewhat noisy if the cable is in motion.

10.4.1 Changing the Data Filter Settings

1. Go to the system setup screen as described in Section 10.1 *Accessing the System Setup Screen*.
2. Use the arrow keys to highlight the **Data filter** selection. See Figure 10.1 Main Menu.
3. Press the **Enter** key. The Data filter setup screen is displayed.

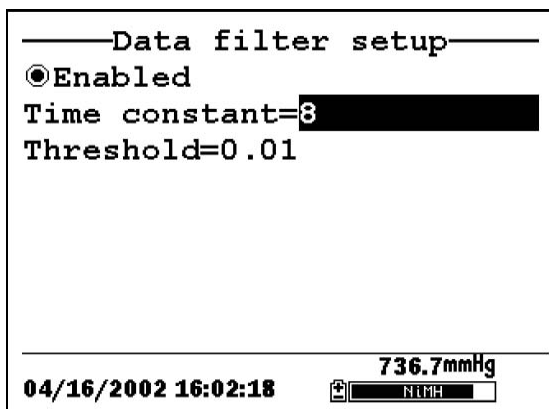

Figure 10.4 Data Filter Screen

4. With Enabled highlighted, press the **Enter** key to Enable or Disable the data filter. A black dot to the left of the selection indicates the data filter is enabled.
5. Use the arrow keys to highlight the **Time constant** field.

NOTE: This value is the time constant in seconds for the software data filter. Increasing the time constant will result in greater filtering of the data, but will also slow down the apparent response of the sensors.

6. Use the keypad to enter a value. The default value is 8 and this value is ideal for most 556 field applications. As described in Section 10.3 *Data Filter* above, users who wish to decrease the response time of the DO readings at the expense of some noise for the pH readings determined

concurrently, should change the Time Constant to a value of 2.

7. Press the **Enter** key to enter the time constant.

8. Use the arrow keys to highlight the **Threshold** field.

NOTE: This value determines when the software data filter will engage/disengage, speeding the response to large changes in a reading. When the difference between two consecutive readings is larger than the threshold, then the reading is displayed unfiltered. When the difference between two consecutive readings drops below the threshold, readings will be filtered again.

9. Use the keypad to enter a value. The default value is 0.01.

10. Press the **Enter** key to enter the threshold.

11. Press the **Escape** key repeatedly to return to the Main menu screen.

10.5 Shutoff Time

The YSI 556 MPS shuts off automatically after 30 minutes of inactivity. The shut off time may be changed as described below.

1. Go to the system setup screen as described in Section *10.1 Accessing the System Setup Screen*.

2. Use the arrow keys to highlight the **Shutoff time** selection on the system setup screen. See Figure 10.2 System Setup Screen.

3. Use the keypad to enter a value from 0 to 60 minutes. The default value is 30.

NOTE: To disable the automatic shutoff feature, enter a zero (0).

4. Press the **Enter** key to enter the correct shutoff time.

5. Press the **Escape** key repeatedly to return to the main menu screen.

10.6 Comma Radix

The user can toggle between a period (default) and comma for the radix mark by selecting this item and pressing the **Enter** key as follows:

1. Go to the system setup screen as described in Section *10.1 Accessing the System Setup Screen*.
2. Use the arrow keys to highlight the **Comma radix** selection on the system setup screen. See Figure 10.2 System Setup Screen.
3. Press the **Enter** key. A check mark appears in the check box next to the comma radix selection indicating that the radix mark is a comma.

10.7 ID

This selection allows you to enter an identification name/number for your YSI 556 MPS. This ID name/number is logged in the header of each file.

1. Go to the system setup screen as described in Section *10.1 Accessing the System Setup Screen*.
2. Use the arrow keys to highlight the **ID** selection. See Figure 10.1 Main Menu.
3. Use the keypad to enter an alphanumeric ID up to 15 characters in length. Refer to Section *2.9 Keypad Use*.
4. Press the **Enter** key to enter the ID.
5. Press the **Escape** key repeatedly to return to the main menu screen.

10.8 GLP Filename

This selection allows you to enter a different filename for the YSI 556 MPS Calibration Record file.

NOTE: The default filename is the “556 PC board Serial Number.glp.”

1. Go to the system setup screen as described in Section 10.1 *Accessing the System Setup Screen*.
2. Use the arrow keys to highlight the **GLP Filename** selection. See Figure 10.1 Main Menu.
3. Use the keypad to enter a filename up to 8 characters in length. Refer to Section 2.9 *Keypad Use*.
4. Press the **Enter** key to enter the new filename.
5. Press the **Escape** key repeatedly to return to the main menu screen.

10.9 TDS Constant

This selection allows you to set the constant used to calculate Total Dissolved Solids (TDS). TDS in g/L is calculated by multiplying this constant times the specific conductance in mS/cm.

10.9.1 Changing the TDS Constant

1. Go to the system setup screen as described in Section 10.1 *Accessing the System Setup Screen*.
2. Use the arrow keys to highlight the **TDS Constant** selection. See Figure 10.1 Main Menu.
3. Use the keypad to enter a value. Refer to Section 2.9 *Keypad Use*. The default value is 0.65.
4. Press the **Enter** key to enter the correct TDS constant.
5. Press the **Escape** key repeatedly to return to the main menu screen.

10.10 Barometer Units

The following information is only for instruments with the barometer option.

1. Go to the system setup screen as described in Section 10.1 *Accessing the System Setup Screen*.
2. Use the arrow keys to highlight the **Barometer units** selection on the system setup screen. See Figure 10.2 System Setup Screen.
3. Press the **Enter** key. The Barometer units screen will appear.

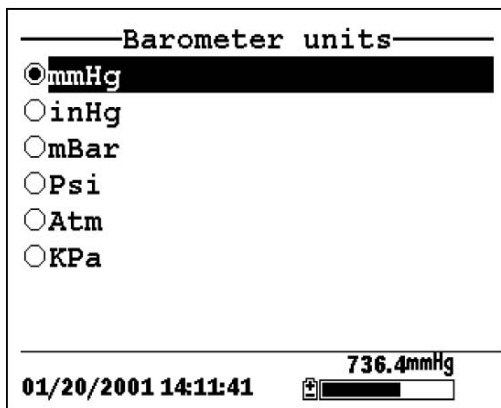

Figure 10.5 Data Filter Screen

A black dot indicates the currently selected units.

4. Use the arrow keys to highlight your desired barometric unit.
5. Press the **Enter** key to select your choice. A black dot will appear in the circle next to your selected units.
6. Press the **Escape** key repeatedly to return to the main menu screen.

10.11 Calibrate Barometer

The optional barometer has been factory calibrated to provide accurate readings. However, some sensor drift may occur over time, requiring occasional calibration by the user, as follows:

1. Determine your local barometric pressure from an independent laboratory barometer or from your local weather service.
2. If the barometric pressure (BP) reading is from your local weather station, reverse the equation that corrects it to sea level.

NOTE: For this equation to be accurate, the barometric pressure units must be in mmHg.

$$\text{True BP} = (\text{Corrected BP}) - [2.5 * (\text{Local Altitude}/100)]$$

3. Go to the system setup screen as described in Section 10.1 *Accessing the System Setup Screen*.
4. Use the arrow keys to highlight the **Calibrate barometer** selection on the system setup screen. See Figure 10.2 System Setup Screen.
5. Press the **Enter** key. The Calibrate Barometer screen is displayed.

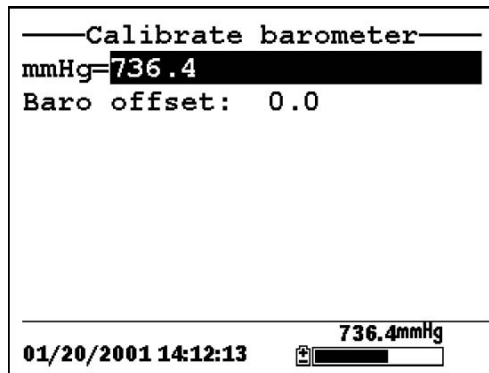

Figure 10.6 Barometer Calibration Screen

6. Use the keypad to input the known barometric pressure value as determined in Step 2.
7. Press the **Enter** key. The new barometer reading is displayed as well as the approximate offset from the factory reading.

NOTE: To return the sensor to the factory setting, subtract the offset amount from the current setting and repeat Steps 5 to 7.

8. Press the **Escape** key repeatedly to return to the main menu screen.

11. Maintenance

11.1 Sensor Care and Maintenance

Once the sensors have been properly installed, remember that periodic cleaning and DO membrane changes are required.

11.1.1 DO Sensor

For best results, we recommend that the KCl solution and the membrane cap be changed at least once every 30 days.

1. It is important to recognize that oxygen dissolved in the sample is consumed during sensor operation. It is therefore essential that the sample be continuously stirred at the sensor tip. If stagnation occurs, your readings will be artificially low. Stirring may be accomplished by mechanically moving the sample around the sensor tip, or by rapidly moving the sensor through the sample. The rate of stirring should be at least 1 foot per second.
2. Membrane life depends on usage. Membranes will last a long time if installed properly and treated with care. Erratic readings are a result of loose, wrinkled, damaged, or fouled membranes, or from large (more than 1/8" diameter) bubbles in the electrolyte reservoir. If erratic readings or evidence of membrane damage occurs, you should replace the membrane and the electrolyte solution. The average replacement interval is two to four weeks.
3. If the membrane is coated with oxygen consuming (e.g. bacteria) or oxygen producing organisms (e.g. algae), erroneous readings may occur.
4. Chlorine, sulfur dioxide, nitric oxide, and nitrous oxide can affect readings by behaving like oxygen at the sensor. If you suspect erroneous readings, it may be necessary to determine if these gases are the cause.
5. Avoid any environment that contains substances that may attack the probe module and sensor materials. Some of these substances are concentrated acids, caustics, and strong solvents. The sensor materials that come in contact

with the sample include FEP Teflon, acrylic plastic, EPR rubber, stainless steel, epoxy, polyetherimide and the PVC cable covering.

6. It is possible for the silver anode, which is the entire silver body of the sensor, to become contaminated. This will prevent successful calibration. To restore the anode, refer to Section *11.1.1 DO Sensor, Silver Anode Cleaning*.
7. For correct sensor operation, the gold cathode must always be bright. If it is tarnished (which can result from contact with certain gases), or plated with silver (which can result from extended use with a loose or wrinkled membrane), the gold surface must be restored. To restore the cathode, refer to Section *11.1.1 DO Sensor, Gold Cathode Cleaning*.
8. To keep the electrolyte from drying out, store the sensor in the transport/calibration cup with at least 1/8" of water.

Silver Anode Cleaning

After extended use, a thick layer of AgCl builds up on the silver anode reducing the sensitivity of the sensor. The anode must be cleaned to remove this layer and restore proper performance. The cleaning can be chemical or mechanical:

Chemical Cleaning: Remove the membrane cap and soak the entire anode section in a 14% ammonium hydroxide solution for 2 to 3 minutes, followed by a thorough rinsing with distilled or deionized water. The anode should then be thoroughly wiped with a wet paper towel to remove the residual layer from the anode.

Mechanical Cleaning: Sand off the dark layer from the silver anode with 400 grit wet/dry sandpaper. Wrap the sandpaper around the anode and twist the sensor. Rinse the anode with clean water after sanding, followed by wiping thoroughly with a wet paper towel.

NOTE: After cleaning, a new membrane cap must be installed. Refer to Section *3.4.3 Membrane Cap Installation*.

Turn the instrument on and allow the system to stabilize for at least 30 minutes. If, after several hours, you are still unable to calibrate, contact your dealer or YSI Customer Service. Refer to *Appendix E Customer Service*.

Gold Cathode Cleaning

For correct sensor operation, the gold cathode must be textured properly. It can become tarnished or plated with silver after extended use. The gold cathode can be cleaned by using the adhesive backed sanding disc and tool provided in the YSI 5238 Probe Reconditioning Kit.

Using the sanding paper provided in the YSI 5238 Probe Reconditioning Kit, wet sand the gold with a twisting motion about 3 times or until all silver deposits are removed and the gold appears to have a matte finish. Rinse the cathode with clean water after sanding, followed by wiping thoroughly with a wet paper towel. If the cathode remains tarnished, contact your dealer or YSI Customer Service. Refer to *Appendix E Customer Service*.

NOTE: After cleaning, a new membrane cap must be installed. Refer to Section 3.4.3 *Membrane Cap Installation*.

11.1.2 DO Sensor Replacement

1. Remove the probe sensor guard.



CAUTION: Thoroughly dry the sensor so that no water enters the probe module sensor port when the sensor is removed.

2. Insert the long end of the hex key wrench into the small hole in the side of the probe module bulkhead. Turn the wrench counterclockwise and remove the screw. (You do not have to remove the screw all the way to release the sensor.)
3. Pull the old DO sensor module straight out of the probe module body.

NOTE: The DO sensor is not threaded, it is keyed, so it cannot be removed by twisting.

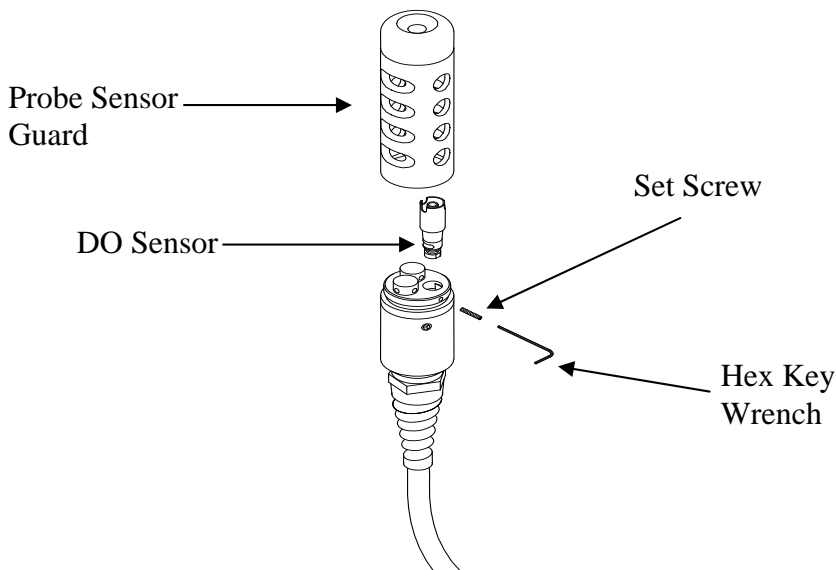

Figure 11.1 DO Sensor Replacement

4. Insert the new DO sensor module. Make sure that the inside of the probe module sensor port and the o-ring on the sensor are clean, with no contaminants, such as grease, dirt, or hair. The DO sensor is keyed, or has a flat side, so that it cannot be aligned improperly.

NOTE: Make sure the DO sensor bottoms out before the set screw is inserted.

5. Insert the set screw into the small hole in the side of the probe module bulkhead, and turn clockwise to rethread.

⚠ CAUTION: Make sure that you do not cross-thread the set screw. Use the hex key wrench to tighten the screw in properly, making sure that the screw does not stick out of the side of the probe module bulkhead. The probe sensor guard will not thread on properly and damage may result if the screw is allowed to stick out.

NOTE: The YSI 5563 DO sensor is shipped dry. A shipping membrane was installed to protect the electrode. A new membrane cap must be installed before the first use. Refer to Section 3.4.1 Sensor Installation.

11.1.3 YSI 5564 pH and 5565 Combination pH/ORP Sensor Cleaning

Cleaning is required whenever deposits or contaminants appear on the glass and/or platinum surfaces of these sensors or when the response of the sensor becomes slow.

1. Remove the sensor from the probe module.
2. Initially, simply use clean water and a soft clean cloth, lens cleaning tissue, or cotton swab to remove all foreign material from the glass bulb (YSI 5564 and YSI 5565) and platinum button (YSI 5565). Then use a moistened cotton swab to carefully remove any material that may be blocking the reference electrode junction of the sensor.

 **CAUTION:** When using a cotton swab with the YSI 5564 or YSI 5565, be careful NOT to wedge the swab tip between the guard and the glass sensor. If necessary, remove cotton from the swab tip, so that the cotton can reach all parts of the sensor tip without stress.

NOTE: If good pH and/or ORP response is not restored by the above procedure, perform the following additional procedure:

1. Soak the sensor for 10-15 minutes in clean water containing a few drops of commercial dishwashing liquid.
2. GENTLY clean the glass bulb and platinum button by rubbing with a cotton swab soaked in the cleaning solution.
3. Rinse the sensor in clean water, wipe with a cotton swab saturated with clean water, and then re-rinse with clean water.

NOTE: If good pH and/or ORP response is still not restored by the above procedure, perform the following additional procedure:

1. Soak the sensor for 30-60 minutes in one molar (1 M) hydrochloric acid (HCl). This reagent can be purchased from most distributors. Be sure to follow the safety instructions included with the acid.
2. GENTLY clean the glass bulb and platinum button by rubbing with a cotton swab soaked in the acid.
3. Rinse the sensor in clean water, wipe with a cotton swab saturated with clean water, and then re-rinse with clean water. To be certain that all traces of the acid are removed from the sensor crevices, soak the sensor in clean water for about an hour with occasional stirring.

NOTE: If biological contamination of the reference junction is suspected or if good response is not restored by the above procedures, perform the following additional cleaning step:

1. Soak the sensor for approximately 1 hour in a 1 to 1 dilution of commercially available chlorine bleach.
2. Rinse the sensor with clean water and then soak for at least 1 hour in clean water with occasional stirring to remove residual bleach from the junction. (If possible, soak the sensor for period of time longer than 1 hour in order to be certain that all traces of chlorine bleach are removed.) Then re-rinse the sensor with clean water and retest.

11.1.4 Temperature/Conductivity Sensor Cleaning

The single most important requirement for accurate and reproducible results in conductivity measurement is a clean cell. A dirty cell will change the conductivity of a solution by contaminating it. The small cleaning brush included in the YSI 5511 Maintenance Kit is ideal for this purpose.

To clean the conductivity cell:

1. Dip the brush in clean water and insert it into each hole 1520 times.
2. Rinse the cell thoroughly in deionized or clean tap water.

NOTE: In the event that deposits have formed on the electrodes, perform the following additional procedure:

1. Use a mild detergent solution in combination with the brush. Dip the brush in the solution and insert it into each hole 1520 times.
2. Rinse the cell thoroughly in deionized or clean tap water.

NOTE: After cleaning, check the response and accuracy of the conductivity cell with a calibration standard.

NOTE: If this procedure is unsuccessful, or if sensor performance is impaired, it may be necessary to return the sensor to a YSI authorized service center for service. Refer to *Appendix E Customer Service*.

The temperature portion of the sensor requires no maintenance.

11.2 Upgrading YSI 556 MPS Software

1. Access the YSI Environmental Software Downloads page as described in *Appendix G EcoWatch* Step 1 through 3.
2. Click on the **YSI Instruments Software Updates** link (or scroll down until you see YSI 556 MPS).
3. Click on the file icon to the right of the **YSI 556 MPS** listing and save the file to a temporary directory on your computer.
4. After the download is complete, run the file (that you just downloaded) and follow the on screen instructions to install the YSI Code Updater on your computer. If you encounter difficulties, contact YSI customer service for advice. Refer to *Appendix E Customer Service*.
5. If necessary, disconnect the YSI 5563 Probe Module from the YSI 556 MPS instrument.

- 6. Connect the YSI 556 MPS to a serial port of your computer via the 655173 PC interface cable. See Figure 8.6 Computer/Instrument Interface.
- 7. Press the **On/off** key on the YSI 556 MPS to display the run screen.
- 8. Run the YSI Code Updater software that you just installed on your computer. The following window will be displayed:

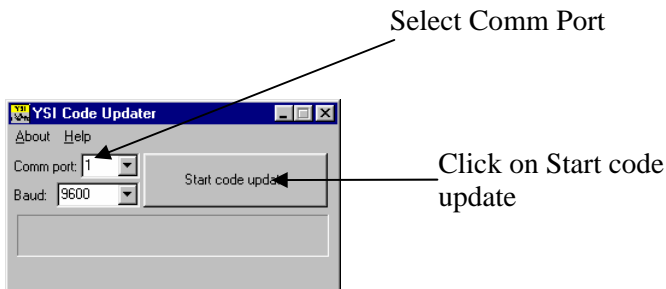

- 9. Set the Comm port number to match the port that you connected the 655173 PC Interface Cable to, then click on the Start Code Update button.

The YSI 556 MPS screen will blank out and a progress indicator will be displayed on the PC.

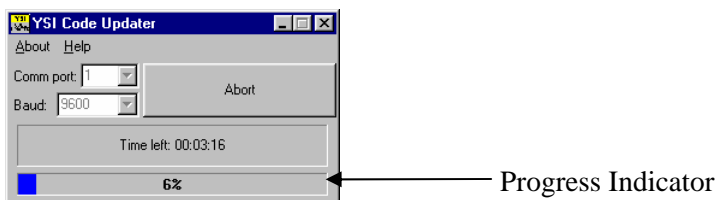

When the update is finished (indicated on the PC screen), the YSI 556 MPS will return to the Run screen. See Figure 7.1 Run Screen.



- 10.** Close the YSI Code Updater window (on the PC) by clicking on the "X" in the upper right corner of the window.
- 11.** Disconnect the YSI 556 MPS from the 655173 PC interface cable and reconnect it to the YSI 5563 Probe Module. Refer to Section 3.6 *Instrument/Cable Connection*.

12. Storage

Proper storage between periods of usage will not only extend the life of the sensors, but will also ensure that the unit will be ready to use as quickly as possible in your next application.

12.1 General Recommendations for Short Term Storage

No matter what sensors are installed in the instrument, it is important to keep them moist without actually immersing them in liquid. Immersing them could cause some of them to drift or result in a shorter lifetime.

YSI recommends that short term storage of all multi-parameter instruments be done by placing approximately 1/2 inch of tap water in the transport/calibration cup that was supplied with the instrument, and by placing the probe module with all of the sensors installed into the cup. The use of a moist sponge instead of a 1/2 inch of tap water is also acceptable, as long as its presence does not compromise the attachment of the cup to the probe module. The transport/calibration cup should be sealed to prevent evaporation.

NOTE: Ensure that an o-ring is installed in the o-ring groove on the threaded end of the probe module body. See Figure 3.7 Transport/Calibration Cup Installation.

 **CAUTION:** The water level has to be low enough so that none of the sensors are actually under water. Check the transport/calibration cup periodically to make certain that the water is still present or the sponge is still moist.

NOTE: If the storage water (tap water) is accidentally lost during field use, environmental water can be used.

12.2 General Recommendations for Long Term Storage

12.2.1 Probe Module Storage

1. Remove the pH or pH/ORP sensor from the probe module and store according to the individual sensor storage instructions found in Section 12.2.2 *Sensor Storage*.
2. Seal the empty port with the provided port plug.

NOTE: Leave the conductivity/temperature sensor and

dissolved oxygen sensor, with membrane cap still on, in the probe module.

3. Place 1/2" of water, deionized, distilled or tap, in the transport/calibration cup.

 **CAUTION:** The water level has to be low enough so that none of the sensors are actually under water. Check the transport/calibration cup periodically to make certain that the water is still present or the sponge is still moist.

4. Insert the probe module into the cup.

NOTE: Ensure that an o-ring is installed in the o-ring groove on the threaded end of the probe module body. See Figure 3.7 Transport/Calibration Cup Installation.

12.2.2 Sensor Storage

Temperature/Conductivity Sensor

No special precautions are required. Sensor can be stored dry or wet, as long as solutions in contact with the thermistor and conductivity electrodes are not corrosive (for example, chlorine bleach). However, it is recommended that the sensor be cleaned with the provided brush prior to long term storage. Refer to Section 11.1.4 *Temperature/Conductivity Sensor Cleaning*.

pH and Combination pH/ORP Sensor

The key to sensor storage is to make certain that the reference electrode junction does not dry out. Junctions which have been allowed to dry out due to improper storage procedures can usually be rehydrated by soaking the sensor for several hours (overnight is recommended) in a solution which is 2 molar in potassium chloride. If potassium chloride solution is not available, soaking the sensor in tap water or commercial pH buffers may restore sensor function. However in some cases the sensor may have been irreparably damaged by the dehydration and will require replacement.

 **CAUTION:** Do not store the sensor in distilled or deionized water as the glass sensor may be damaged by exposure to this medium.

1. Remove the pH or pH/ORP sensor from the probe module.

2. Seal the empty port with the provided port plug.
3. Place the sensor in the storage vessel (plastic boot or bottle) which was on the sensor at delivery. The vessel should contain a solution which is 2 molar in potassium chloride.

NOTE: Make certain that the vessel is sealed to prevent evaporation of the storage solution.

13. Troubleshooting

The following sections describe problems you may encounter when using the YSI 556 MPS and provides suggestions to overcome the symptom.

PROBLEM	POSSIBLE SOLUTION
Display Problems	
No display is visible after pressing the on/off key.	If C cells are used, make certain that they are installed properly with regard to polarity and that good batteries are used. If a rechargeable battery pack is used, place the pack in the instrument and charge for 30 minutes.
Instrument software appears to be locked up as evidenced by no response to keypad entries or display not changing.	First, attempt to reset the instrument by simply turning off and then on again. If this fails, remove battery power from the instrument for 30 seconds and then reapply power. When using C cells, remove the battery lid and one of the batteries; when using the rechargeable battery pack, remove the pack completely from the instrument. After 30 seconds replace the battery or battery pack and check for instrument function.
The 556 display flashes and the instrument speaker makes a continuous clicking sound.	The battery voltage is low. Change to new C cells or recharge the 6117 battery pack.
Water Damage to Instrument	
Leakage detected in battery compartment when using C cells.	Dispose of batteries properly. Dry the battery compartment using compressed air if possible. If corrosion is present on battery terminals, contact YSI Customer Service.
Water has contacted rechargeable battery pack.	Remove battery pack immediately. Send battery pack to YSI Product Service for evaluation. CAUTION: DO NOT REUSE BATTERY PACK UNTIL YSI PRODUCT SERVICE HAS EVALUATED IT.
Leakage suspected into the main cavity of the instrument case.	Remove the batteries immediately. Return the instrument to YSI Product Service.

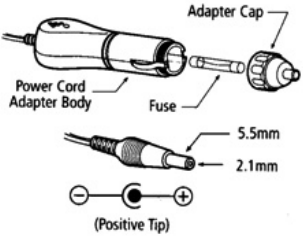
PROBLEM	POSSIBLE SOLUTIONS
Optional Cigarette Lighter Charger	
<p>Power cord fuse blown.</p>  <p>The diagram illustrates the components of a cigarette lighter adapter. It includes an Adapter Cap, a Power Cord Adapter Body, and a Fuse. A close-up view shows the tip of the adapter with dimensions of 5.5mm and 2.1mm, and a label indicating it is a Positive Tip.</p>	<ol style="list-style-type: none"> 1. Unscrew adapter's cap, remove tip and pull out fuse. 2. Replace fuse with a new 2-amp fast-blow fuse from an electronics store such as Radio Shack. 3. Reassemble the adapter and securely screw the cap back onto the adapter body.
File Problems	
<p>Upload of files from YSI 556 MPS to PC fails</p>	<ol style="list-style-type: none"> 1. Make sure that cable is connected properly to both 556 and PC. 2. Make certain that the proper Comm port is selected in EcoWatch for Windows.
<p>Barometer data is not stored with sensor data file.</p>	<p>Make sure Store barometer is active in the 556 Logging setup menu.</p>
<p>Site Descriptions in the Site List are "grayed-out" and not available for appending files with additional data.</p>	<p>There is a parameter mismatch between the current 556 setup and that initially used. Change the current logging and sensor setup to match the setup that was initially used to create the file.</p>
Sensor Problems	
<p>Dissolved Oxygen reading is unstable or inaccurate. Out of Range message appears during calibration.</p>	<p>Sensor not properly calibrated. Follow DO cal procedures.</p>
	<p>Membrane not properly installed or may be punctured. Replace membrane cap.</p>
	<p>DO sensor electrodes require cleaning. Follow DO cleaning procedure. Use 5511 Maintenance kit.</p>
	<p>Water in sensor connector. Dry connector; reinstall sensor.</p>
	<p>Algae or other contaminant clinging to DO sensor. Rinse DO sensor with clean water.</p>
	<p>Barometric pressure entry is incorrect. Repeat DO cal procedure.</p>
	<p>Calibrated at extreme temperature. Recalibrate at (or near) sample temperature.</p>
	<p>DO sensor has been damaged. Replace sensor.</p> <p>Internal failure. Return probe module for service.</p>

PROBLEM	POSSIBLE SOLUTIONS
Sensor Problems	
pH or ORP readings are unstable or inaccurate. Out of Range message appears during calibration.	Sensor requires cleaning. Follow sensor cleaning procedure.
	Sensor requires calibration. Follow cal procedures.
	pH sensor reference junction has dried out from improper storage. Soak sensor in tap water or buffer 4 until readings become stable.
	Water in sensor connector. Dry connector; reinstall sensor.
	Sensor has been damaged. Replace sensor.
	Calibration solutions out of spec or contaminated with other solution. Use new calibration solutions
	ORP fails Zobell check. Take into account temperature dependence of Zobell solution readings.
Conductivity unstable or inaccurate. Out of Range message appears during calibration	Conductivity improperly calibrated. Follow calibration procedure.
	Conductivity sensor requires cleaning. Follow cleaning procedure.
	Conductivity sensor damaged. Replace sensor.
	Calibration solution out of spec or contaminated. Use new calibration solution.
	Internal failure. Return probe module for service.
	Calibration solution or sample does not cover entire sensor. Immerse sensor fully.
Temperature, unstable or inaccurate	Water in connector. Dry connector; reinstall sensor.
	Sensor has been damaged. Replace the 5560 sensor.
Installed sensor has no reading	The sensor has been disabled. Enable sensor.
	Water in sensor connector. Dry connector; reinstall sensor.
	Sensor has been damaged. Replace sensor.
	Report output improperly set up. Set up report output.
	Internal failure. Return probe module for service.

If these guidelines and tips fail to correct your problem or if any other symptoms occur, contact YSI Customer Service for Advice. Refer to *Appendix E Customer Service*.

14. Appendix A YSI 556 MPS Specifications

For the most recent product specifications, please visit the YSI website:
www.ysi.com

15. Appendix B Instrument Accessories

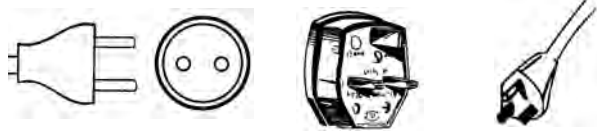
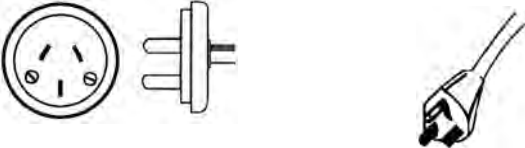
ITEM #	ACCESSORY
5563-4	4m Cable with DO/temp/conductivity
5563-10	10m Cable with DO/temp/conductivity
5563-20	20m Cable with DO/temp/conductivity
5564	pH Kit
5565	pH/ORP Kit
6118	Rechargeable Battery Pack Kit for use in US
5094	Rechargeable Battery Pack Kit with universal charger and three adapter cables for use in international applications 
5095	Rechargeable Battery Pack Kit with universal charger and two adapter cables for use in international applications 
5083	Flow Cell – probe module is secured in the flow cell and groundwater is pumped through it. Displaced volume approx. 475 ml
3059	Flow Cell, low volume. Displaced volume approx. 200 ml
116505	Battery Lid
616	Charger, Cigarette Lighter – used to power up the instrument from a car's cigarette lighter
4654	Tripod
614	Ultra Clamp, C Clamp –used to clamp the instrument to a table top or car dashboard
6081	Large Carrying Case, Hard-sided
5085	Hands-free Harness
5065	Carrying Case, Form-fitted, for use in the field – has a clear vinyl window, shoulder strap, belt loop strap and hand strap

16. Appendix C Required Federal Communications Notice

The Federal Communications Commission defines this product as a computing device and requires the following notice.

This equipment generates and uses radio frequency energy and if not installed and used properly, may cause interference to radio and television reception. It has been type tested and found to comply with the limits for a Class A or Class B computing device in accordance with the specification in Subpart J of Part 15 of FCC Rules, which are designed to provide reasonable protection against such interference in a residential installation. However, there is no guarantee that interference will not occur in a particular installation. If this equipment does cause interference to radio or television reception, which can be determined by turning the equipment off and on, the user is encouraged to try to correct the interference by one or more of the following measures:

- Reorient the receiving antenna
- Relocate the computer with respect to the receiver
- Move the computer away from the receiver
- Plug the computer into a different outlet so that the computer and receiver are on different branch circuits.

If necessary, the user should consult the dealer or an experienced radio/television technician for additional suggestions. The user may find the following booklet, prepared by the Federal Communications Commission, helpful: "How to Identify and Resolve Radio-TV Interference Problems". This booklet is available from the U.S. Government Printing Office, Washington, D.C. 20402, Stock No.0004-000-00345-4.

17. Appendix D Health Safety

YSI Conductivity Solutions: 3161, 3163, 3165, 3167, 3168, 3169

INGREDIENTS:

- Iodine
- Potassium Chloride
- Water

WARNING: INHALATION MAY BE FATAL

 **CAUTION: AVOID INHALATION, SKIN CONTACT, EYE CONTACT OR INGESTION. MAY EVOLVE TOXIC FUMES IN FIRE.**

Harmful if ingested or inhaled. Skin or eye contact may cause irritation. Has a corrosive effect on the gastro-intestinal tract, causing abdominal pain, vomiting, and diarrhea. Hyper-sensitivity may cause conjunctivitis, bronchitis, skin rashes etc. Evidence of reproductive effects.

FIRST AID:

INHALATION: Remove victim from exposure area. Keep warm and rest. In severe cases seek medical attention.

SKIN CONTACT: Remove contaminated cloth immediately. Wash affected area thoroughly with large amounts of water. In severe cases seek medical attention.

EYE CONTACT: Wash eyes immediately with large amounts of water, (approx. 10 minutes). Seek medical attention immediately.

INGESTION: Wash out mouth thoroughly with large amounts of water. Seek medical attention immediately.

YSI pH 4.00, 7.00, y 10.00: 3821, 3822, 3823**pH 4 INGREDIENTS:**

- Potassium Hydrogen Phthalate
- Formaldehyde
- Water

pH 7 INGREDIENTS:

- Sodium Phosphate, Dibasic
- Potassium Phosphate, Monobasic
- Water

pH 10 INGREDIENTS:

- Potassium Borate, Tetra
- Potassium Carbonate
- Potassium Hydroxide
- Sodium (di) Ethylenediamine Tetraacetate
- Water

 **CAUTION -AVOID INHALATION, SKIN CONTACT, EYE CONTACT OR INGESTION. MAY AFFECT MUCOUS MEMBRANES.**

Inhalation may cause severe irritation and be harmful. Skin contact may cause irritation; prolonged or repeated exposure may cause Dermatitis. Eye contact may cause irritation or conjunctivitis. Ingestion may cause nausea, vomiting and diarrhea.

FIRST AID:

INHALATION – Remove victim from exposure area to fresh air immediately. If breathing has stopped, give artificial respiration. Keep victim warm and at rest. Seek medical attention immediately.

SKIN CONTACT – Remove contaminated clothing immediately. Wash affected area with soap or mild detergent and large amounts of water (approx. 15-20 minutes). Seek medical attention immediately.

EYE CONTACT - Wash eyes immediately with large amounts of water (approx. 15-20 minutes), occasionally lifting upper and lower lids. Seek medical attention immediately.

INGESTION – If victim is conscious, immediately give 2 to 4 glasses of water and induce vomiting by touching finger to back of throat. Seek medical attention immediately.

YSI Zobell Solution: 3682

INGREDIENTS:

- Potassium Chloride
- Potassium Ferrocyanide Trihydrate
- Potassium Ferricyanide

⚠ CAUTION -AVOID INHALATION, SKIN CONTACT, EYE CONTACT OR INGESTION. MAY AFFECT MUCOUS MEMBRANES.

May be harmful by inhalation, ingestion, or skin absorption. Causes eye and skin irritation. Material is irritating to mucous membranes and upper respiratory tract. The chemical, physical, and toxicological properties have not been thoroughly investigated.

Ingestion of large quantities can cause weakness, gastrointestinal irritation and circulatory disturbances.

FIRST AID:

INHALATION – Remove victim from exposure area to fresh air immediately. If breathing has stopped, give artificial respiration. Keep victim warm and at rest. Seek medical attention immediately.

SKIN CONTACT – Remove contaminated clothing immediately. Wash affected area with soap or mild detergent and large amounts of water (approx. 15-20 minutes). Seek medical attention immediately.

EYE CONTACT - Wash eyes immediately with large amounts of water (approx. 15-20 minutes), occasionally lifting upper and lower lids. Seek medical attention immediately.

INGESTION – If victim is conscious, immediately give 2 to 4 glasses of water and induce vomiting by touching finger to back of throat. Seek medical attention immediately.

18. Appendix E Customer Service

18.1 Ordering and Technical Support

Telephone: 800 897 4151 (US)
+1 937 767 7241 (Globally)
Monday through Friday, 8:00 AM to 5:00 ET

Fax: +1 937 767 9353 (orders)
+1 937 767 1058 (technical support)

Email: environmental@ysi.com or proseries@ysi.com

Mail: YSI Incorporated
1725 Brannum Lane
Yellow Springs, OH 45387 USA

Website: www.ysi.com

18.2 YSI Authorized Service Centers

YSI has authorized service centers throughout the United States and Internationally. For the nearest service center information, please visit www.ysi.com and click 'Support' or contact YSI Technical Support directly at 800-897-4151.

When returning a product for service, include the Product Return form with cleaning certification. The form must be completely filled out for a YSI Service Center to accept the instrument for service. The form may be downloaded from www.ysi.com by clicking on the 'Support' tab, then the Product Return Form button.

18.3 Cleaning Instructions

Equipment exposed to biological, radioactive, or toxic materials must be cleaned and disinfected before being serviced. Biological contamination is presumed for any instrument, probe, or other device that has been used with body fluids or tissues, or with wastewater. Radioactive contamination is presumed for any instrument, probe or other device that has been used near any radioactive source.

If an instrument, probe, or other part is returned or presented for service without a Cleaning Certificate, and if in our opinion it represents a potential

biological or radioactive hazard, our service personnel reserve the right to withhold service until appropriate cleaning, decontamination, and certification has been completed. We will contact the sender for instructions as to the disposition of the equipment. Disposition costs will be the responsibility of the sender.

When service is required, either at the user's facility or at a YSI Service Center, the following steps must be taken to ensure the safety of service personnel.

- In a manner appropriate to each device, decontaminate all exposed surfaces, including any containers. 70% isopropyl alcohol or a solution of 1/4-cup bleach to 1-gallon tap water is suitable for most disinfecting. Instruments used with wastewater may be disinfected with .5% Lysol if this is more convenient to the user.
- The user shall take normal precautions to prevent radioactive contamination and must use appropriate decontamination procedures should exposure occur.
- If exposure has occurred, the customer must certify that decontamination has been accomplished and that no radioactivity is detectable by survey equipment.
- Any product being returned to the YSI Repair Center should be packed securely to prevent damage.
- Cleaning must be completed and certified on any product before returning it to YSI.

18.4 Packing Procedure

- Clean and decontaminate items to ensure the safety of the handler.
- Complete and include the Cleaning Certificate.
- Place the product in a plastic bag to keep out dirt and packing material.
- Use a large carton, preferably the original, and surround the product completely with packing material.
- Insure for the replacement value of the product.

18.5 Warranty

The instrument is warranted for three years against defects in workmanship and materials when used for its intended purposes and maintained according to instructions. The probe module and cables are warranted for one year. The dissolved oxygen, temperature/conductivity, pH, and pH/ORP combination sensors are warranted for one year. Damage due to accidents, misuse, tampering, or failure to perform prescribed maintenance is not covered. The warranty period for chemicals and reagents is determined by the expiration date printed on their labels. Within the warranty period, YSI will repair or replace, at its sole discretion, free of charge, any product that YSI determines to be covered by this warranty.

To exercise this warranty, write or call your local YSI representative, or contact YSI Customer Service in Yellow Springs, Ohio. Send the product and proof of purchase, transportation prepaid, to the Authorized Service Center selected by YSI. Repair or replacement will be made and the product returned transportation prepaid. Repaired or replaced products are warranted for the balance of the original warranty period, or at least 90 days from date of repair or replacement.

Limitation of Warranty

This Warranty does not apply to any YSI product damage or failure caused by (i) failure to install, operate or use the product in accordance with YSI's written instructions, (ii) abuse or misuse of the product, (iii) failure to maintain the product in accordance with YSI's written instructions or standard industry procedure, (iv) any improper repairs to the product, (v) use by you of defective or improper components or parts in servicing or repairing the product, or (vi) modification of the product in any way not expressly authorized by YSI.

THIS WARRANTY IS IN LIEU OF ALL OTHER WARRANTIES, EXPRESSED OR IMPLIED, INCLUDING ANY WARRANTY OF MERCHANTABILITY OR FITNESS FOR A PARTICULAR PURPOSE. YSI'S LIABILITY UNDER THIS WARRANTY IS LIMITED TO REPAIR OR REPLACEMENT OF THE PRODUCT, AND THIS SHALL BE YOUR SOLE AND EXCLUSIVE REMEDY FOR ANY DEFECTIVE PRODUCT COVERED BY THIS WARRANTY. IN NO EVENT SHALL YSI BE LIABLE FOR ANY SPECIAL, INDIRECT, INCIDENTAL OR CONSEQUENTIAL DAMAGES RESULTING FROM ANY DEFECTIVE PRODUCT COVERED BY THIS WARRANTY.

19. Appendix F Ferrite Bead Installation

⚠ WARNING: If you are using your YSI 556 in a European Community (CE) country or in Australia or New Zealand, you must attach a ferrite bead to the 655173 PC Interface Cable and the YSI 6117 Charger Adapter Cable in order to comply with the Residential, Commercial and Light Industrial Class B Limits for radio-frequency emissions specified in EN55011 (CISPR11) for Industrial, Scientific and Medical laboratory equipment. These ferrite assemblies are supplied as part of cable kits.

1. Make a small loop (approximately 5 cm in diameter) in the cable near the YSI 556 MS-19 connector.
2. Lay the open ferrite bead assembly under the loop with the cable cross-over position within the cylinder of the ferrite bead.

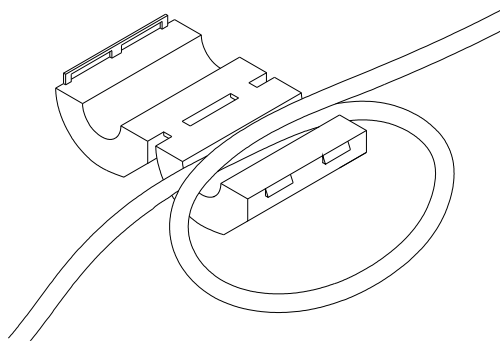

Figure 19.1 Ferrite Bead Installation

3. Snap the two pieces of the bead together making certain that the tabs lock securely.
4. When the installation is complete, the 655173 and 6117 cables should resemble the following drawings.

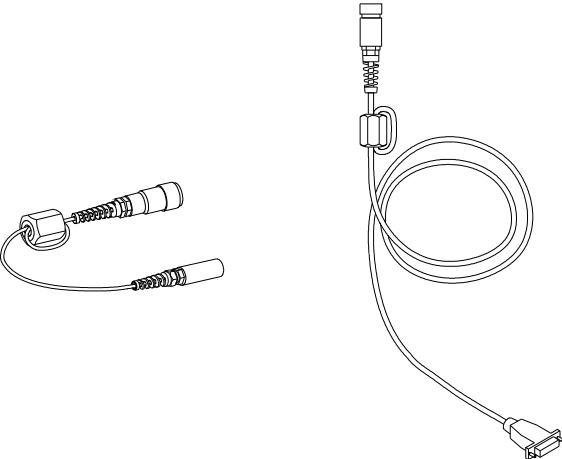

Figure 19.2 Cables with Ferrite Beads

20. Appendix G EcoWatch

EcoWatch™ for Windows™ must be used as the PC software interface to the YSI 556 MPS. EcoWatch is a powerful tool that can also be used with YSI 6-series sondes. Many features of the software will only be utilized by advanced users or are not relevant to the 556 MPS at all. This section is designed in tutorial format to familiarize you with the commonly used features of EcoWatch so that it will be possible to:

- Upload data from a 556 MPS to a PC
- Assemble plots and reports of your data
- Zoom in on certain segments of the plots of your data to facilitate analysis
- Show statistical data for your studies
- Export data in spreadsheet-compatible formats
- Print plots and reports

The advanced features of EcoWatch can be explored by downloading a 6-series manual from the YSI Web Site (www.ysi.com), purchasing a hard copy of the manual through YSI Customer Service (Item # 069300), or utilizing the on-line help feature of the software.

20.1 Installing EcoWatch for Windows

EcoWatch for Windows is available at no cost via a download from the YSI Web Site – www.ysi.com

20.2 EcoWatch Tutorial

This EcoWatch tutorial is designed to teach you the commonly used operations associated with the software when used with your 556 MPS.

After you have uploaded a file, Refer to Section [8.4 Upload to PC](#), you will see two files in the C:\ECOWWIN\DATA directory; the file you transferred and a file supplied by YSI designated SAMPLE.DAT. This SAMPLE.DAT file is referred to in the remainder of this tutorial section. After following the instructions below for the analysis of SAMPLE.DAT, you apply the same analysis to the data file which was uploaded from your 556 MPS to assure that you are familiar with the basic features and capabilities of EcoWatch for Windows.

To start the analysis of the SAMPLE.DAT file, note that a shortened menu

bar is visible and many of the tools in the toolbar appear dimmed or “grayed out” before any file is opened (see below).

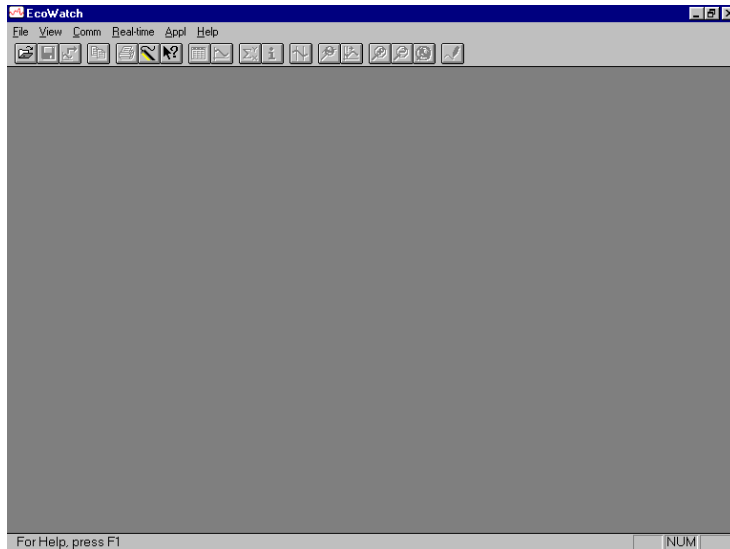

Full activation of EcoWatch features will be realized after a file is opened.



To open the sample data file:

1. Click the **File** menu  button in the toolbar.
2. Select the **SAMPLE.DAT** file.
3. Click **OK** to open the file.

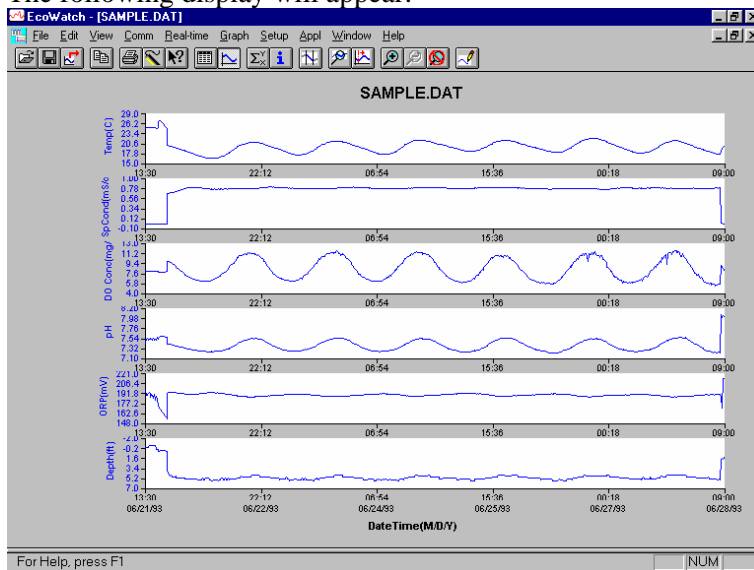
The following display will appear:





Note that the data in this file appears as a graph of temperature, specific conductance, dissolved oxygen, pH, ORP, and depth, all versus time. The graphs are scaled automatically so that all data fits comfortably on the computer screen. Note also that this data file was obtained with a 6-series sonde for which a depth sensor is available. Depth is NOT a current parameter for the 556 MPS.

The **Table**  and **Graph**  buttons on the toolbar are on/off switches that are used to display or hide the graph and table pages respectively. When displaying a graph and a table at the same time, you can control the relative size of the two pages by placing the cursor over the small bar that separates them and

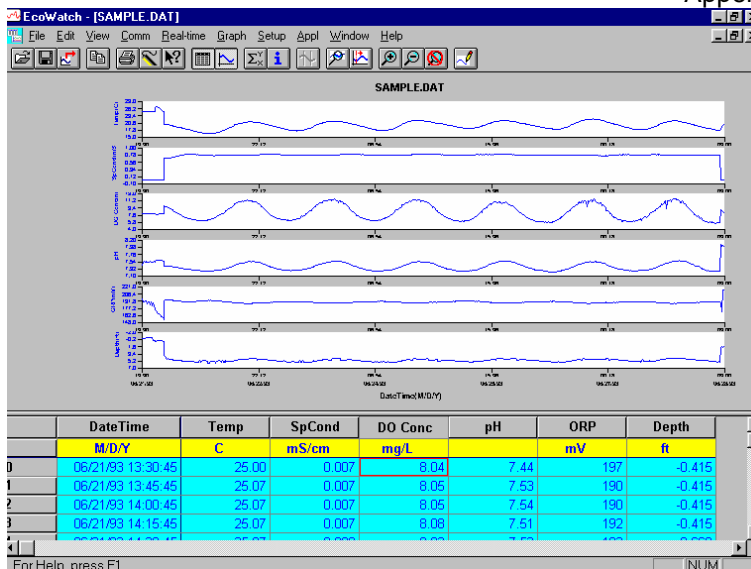
then dragging it to the desired location. Click the **Table**  button to generate the following dual display of data.



Now click the **Graph**  button (turn it off) to display only a report of your data as shown below. Note that the size of the report can be varied by clicking on the  and  buttons in the Toolbar.

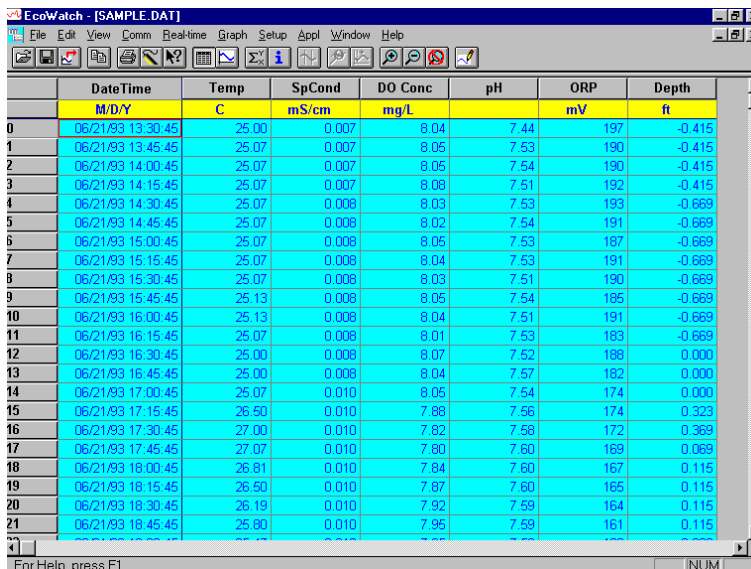



Now return to the original graphic display by toggling the **Table** button “off” and **Graph**  button “on”.

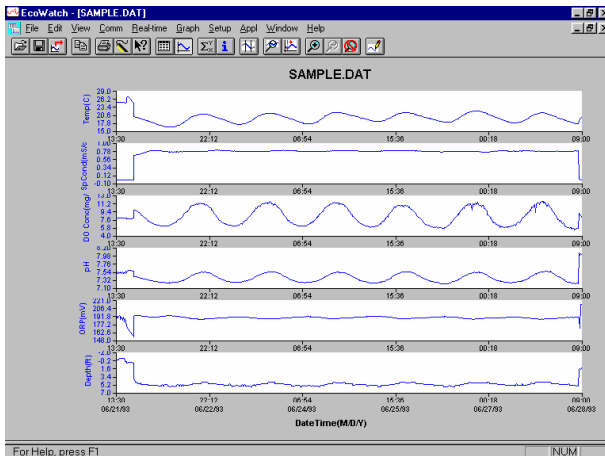

From the **Setup** menu, click **Graph**. Click **2 Traces per Graph** and notice that the parameters are now graphed in pairs for easy comparison of parameters.

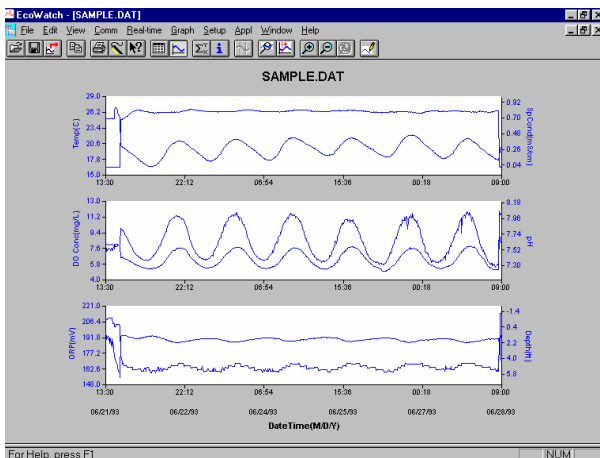

Click **1 Trace per Graph** to return the display to the original setting. Move the cursor to any position in the graph, then click and hold the right mouse button.

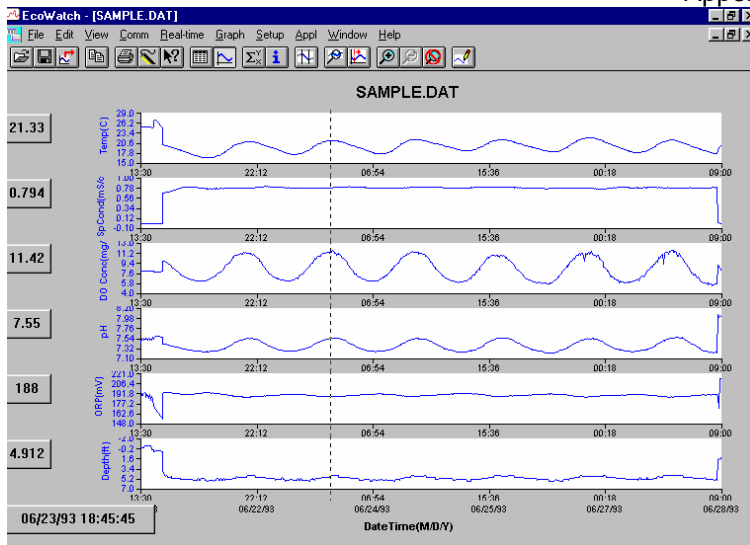

Note that the exact measurements for this point in time are displayed to the left of the graph. While holding down the right mouse button, move to another area on the graph. Notice how the measurements change as you move. When you release the mouse button, the display returns to normal.

To view statistical information for the study, click the **Statistics**  button on the toolbar. On the statistics window, click on any min or max value to display the time when it occurred.

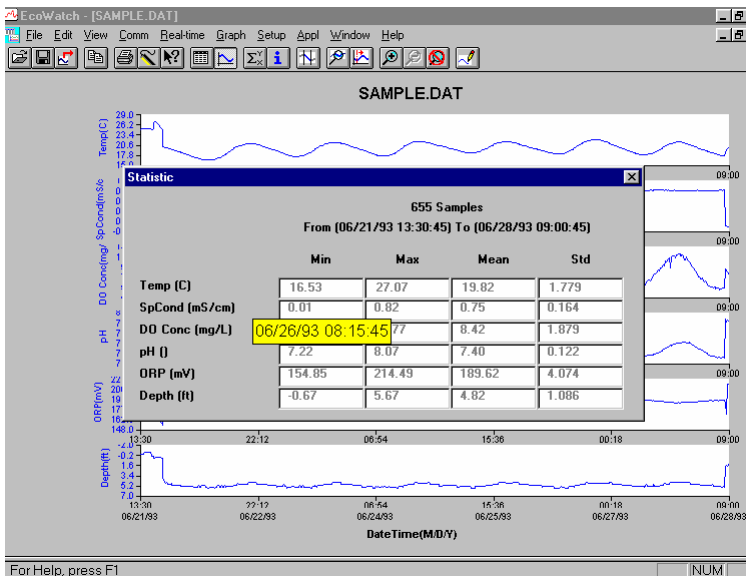

After viewing statistics, click the “x” at the upper right to close the window and return to the normal display.

Now click on the delimiter  icon in the toolbar and then move the displayed icon to the graph. Click at the two points shown by dotted lines in the display below, being sure that the first click is to the left of the second.

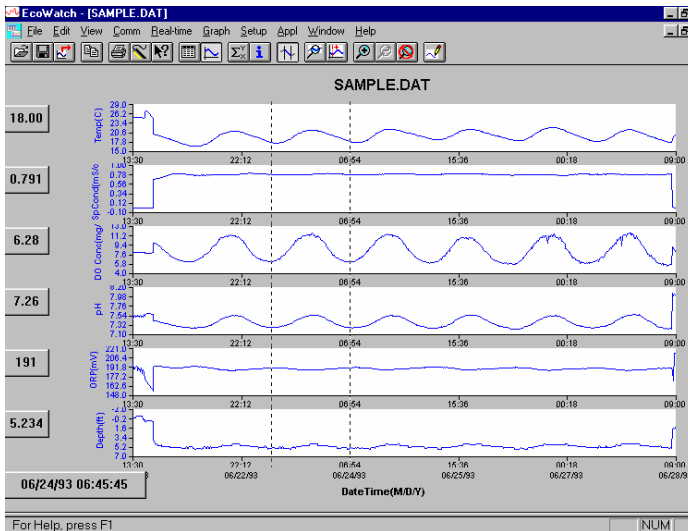

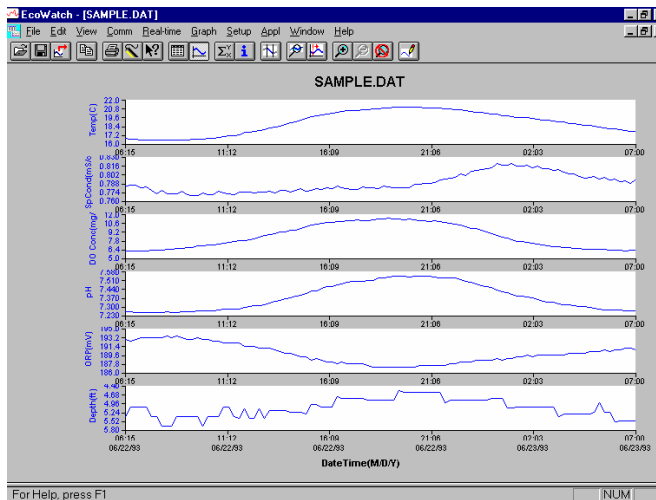

The data between the two selected points will then be graphed in higher resolution as shown below.

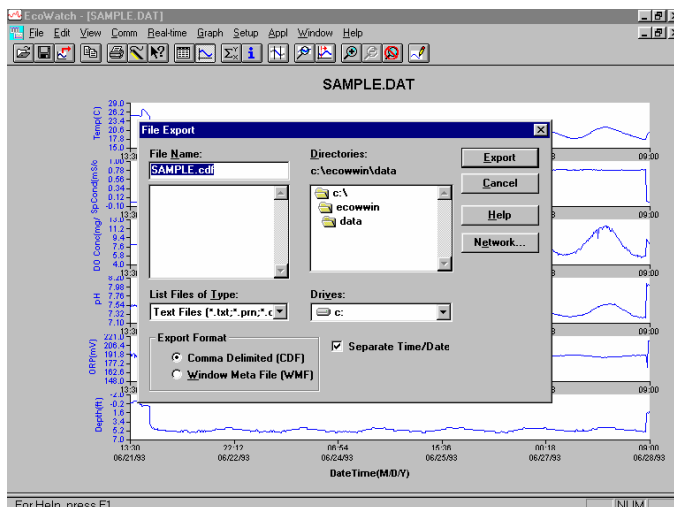

To return to the complete data set, select **Graph** from the toolbar and then click **Cancel Limits**.

Now select the  icon from the Toolbar to create a new data file which will allow your data to be imported into spreadsheets. Select the default export settings for a Comma Delimited File (.CDF) and click OK. A new spreadsheet-importable file (SAMPLE.CDF) is now present in the same folder as the SAMPLE.DAT file.



Now select the  icon from the toolbar to print the plot. Accept the default settings and click OK to complete the printing operation.

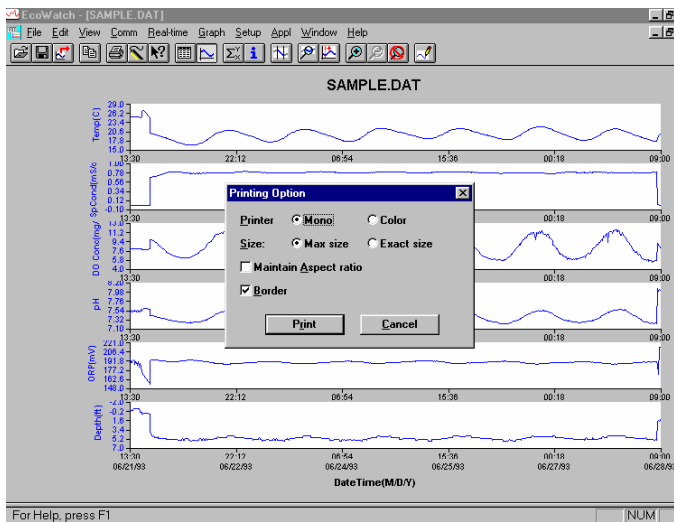

Finally, end the tutorial by saving the **Data Display** in the format shown. From the File menu, click **Save Data Display**.

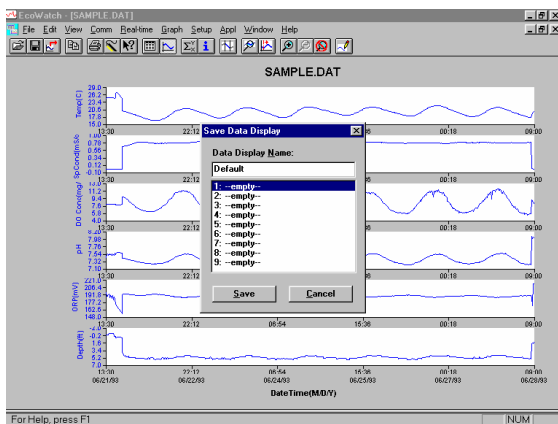

Then type “Default” for the file name and click **Save**. The parameters, colors, format, and x-axis time interval associated with the current display are now saved and can be accessed any time in the future. Nine different data displays may be saved for any data file. You can easily switch between various displays of the data. The data files can be accessed by clicking **Load Data Display** from the file menu and then selecting the desired presentation.

20.2.1 Summary of Toolbar Capability

The EcoWatch toolbar includes buttons for some of the most common commands in EcoWatch, such as **File Open**. To display or hide the toolbar,

open the **View** menu and click on the **Toolbar** command. A check mark appears next to the menu item when the toolbar is displayed.

The toolbar is displayed across the top of the application window, below the menu bar.



Click to:



Open an existing data file (.DAT). EcoWatch displays the **Open** dialog box, in which you can locate and open the desired file.



Save the working Data Display of the active data file. EcoWatch displays the **Save Data Display** dialog box in which you can overwrite existing Data Display or save to a new one.



Export data as a graph in Window Meta File (.WMF) format or as data in Comma Delimited (.CDF) format.



Copy the whole graph page or data from the selection on the table to the clipboard.



Print the active graph page or table page depending on which one is currently active.



Open a new terminal window to communicate with the sonde.



Access context sensitive help (Shift+F1).



Toggle table window during file processing.



Toggle graph window during file processing.



Display study statistics.



Display study info.



Limit the data to be processed.



Enlarge a selective portion of graph.



Center the graph under the cursor.



Enlarge graph of table 20%.



Reduce graph of table 20%.



Return graph or table to its normal size (unzoom).



Redraw the graph.

20.2.2 Other capabilities

The above tutorial and function list for the toolbar provide basic information to allow you to view and analyze the field data which was stored in your 556 MPS. Some of the other commonly used capabilities of EcoWatch which the user may want to explore are listed below:

- Customize the units for each parameter, e.g., report uS/cm instead of mS/cm for conductivity.
- Customize the order of parameters in each plot or report.
- Customize the colors and fonts of each data display.
- Manually scale the y-axis sensitivity for each parameter.
- Merging of two or more data files with compatible parameter formats
- View information about the study such as number of points, instrument serial number, etc. which was stored in the 556 with the data.
- Print data reports in different statistical formats.
- Create plots of parameter vs. parameter rather than parameter vs. time.

These additional features of EcoWatch for Windows are explained in detail in the YSI 6-series manual (which can be downloaded at no cost from the YSI Web Site as described above) and the Help selection in the EcoWatch menu bar. To purchase a hard copy of the 6-series manual, contact YSI Customer Service using the contact information in *Appendix E Customer Service*.

21. Appendix H Calibration Record Information

When your YSI 556 MPS sensors are initially calibrated, relevant information about the sensors will be stored in a separate file in the YSI 556 MPS memory.

NOTE: This file, by default, will have the name “556 Circuit Board Serial Number.glp.” The circuit board serial number is assigned at the factory and has a hexadecimal format such as 000080A4. Thus the default calibration record file would be designated 00080A4.glp. Refer to Section 10.7 *GLP Filename* to change the filename.

The information in the calibration record will track the sensor performance of your instrument and should be particularly useful for programs operating under Good Laboratory Practices (GLP) protocols.

21.1 Viewing the Calibration Record (.glp) File

NOTE: Make certain that you have performed a calibration on at least one of the sensors associated with your YSI 556 MPS.

Follow the procedures outlined in Section 8.3 *View File*.

21.2 Uploading the Calibration Record (.glp) File

NOTE: Make certain that you have performed a calibration on at least one of the sensors associated with your YSI 556 MPS.

Follow the procedures outlined in Section 8.4 *Upload to PC*.

21.3 Understanding the Calibration Record (.glp) File

1. Open a calibration record file. Refer to Section 8.3 *View File*.
2. Use the arrow keys to scroll horizontally and/or vertically to view all the data.

00008003 .glp		
m/d/y	hh:mm:ss	S/N
01/24/2001	08:17:51	00008003
01/24/2001	08:17:51	00008003
01/24/2001	08:17:51	00008003
01/24/2001	08:17:51	00008003
01/24/2001	08:17:51	00008003
01/24/2001	08:17:51	00008003
01/24/2001	08:17:51	00008003
01/24/2001	08:17:51	00008003
01/24/2001	08:25:40	00008003
01/24/2001	08:25:40	00008003

735.9mmHg

01/24/2001 08:39:53

Figure 21.1 Calibration Record Screen 1

00008003 .glp		
Type	Value	
Conductivity gain	1.000000	
DO gain	1.000000	
pH gain (pH-7) *K/mV	-5.05833	
pH offset (pH-7) *K	0.000000	
ORP offset mV	0.000000	
TDS constant	0.650000	
Barometer offset PSI	0.000000	
DO gain	1.110250	
pH gain (pH-7) *K/mV	-5.05833	
pH offset (pH-7) *K	-12.2899	

735.9mmHg

01/24/2001 08:39:19

Figure 21.2 Calibration Record Screen 2

NOTE: Each sensor (not parameter) is characterized by either 1 line (Conductivity, Dissolved Oxygen, ORP, TDS, or Barometer (Optional)) or 2 lines (pH) of calibration documentation.

The left hand portion of each calibration entry shows the date and time that a calibration of a particular sensor was performed. In addition, each calibration entry is characterized by the instrument serial number, as defined by YSI. See Figure 21.1 Calibration Record Screen 1. The right hand portion shows the YSI designation of the calibration constants and their values after their calibration has been performed. A more detailed description of the calibration constants is provided below:

- **Conductivity Gain** – A relative number which describes the sensitivity of the sensor. Basically, the value represents the calculated cell constant divided by the typical value of the cell constant (5 cm⁻¹).
- **DO Gain** – A relative number which describes the sensitivity of the sensor. Basically, the value represents the sensor current at the time of calibration divided by the typical value of the sensor current (15 uA).
- **pH Gain** – A number which basically represents the sensitivity of the pH sensor. To remove the effect of temperature on the slope of the relationship of probe output in mv versus pH, the value of pH/mv is multiplied by the temperature in degrees Kelvin (K).
- **pH Offset** – A number which basically represents the offset (or intercept) of the relationship of probe output in mv versus pH, the value of pH is multiplied by the temperature in degrees Kelvin (K).

Anytime you perform a calibration, information concerning the calibration constants will be logged to the Calibration Record file (.glp file). However, if the **Delete All Files** command is used, Refer to Section 8.6 *Delete All Files*, the Calibration Record file will also be lost. It is critical that this file should be uploaded to your PC prior to issuing a **Delete All Files** command. Refer to Section 8.4 *Upload to PC*.



YSI Environmental
1700/1725 Brannum Lane
Yellow Springs, OH
45387 USA
937.767.7241
937.767.9353 fax
environmental@YSI.com
www.YSI.com

Item # 655279
Rev D
Drawing # A655279
August 2009
©2009 YSI Incorporated