



# TIGER

Instrument User Manual V4.0R

---



Register  
your instrument online  
to receive your  
extended Warranty.

Unrivaled Gas Detecti**ion**.

[ionscience.com/usa](https://www.ionscience.com/usa)

## **Register your instrument online for extended warranty**

Thank you for purchasing your ION Science instrument.

The standard warranty of your instrument can be extended to five years.

To receive your extended warranty, you must register your instrument online within one month of purchase (terms and conditions apply.)

Visit [www.ionscience.com/usa](http://www.ionscience.com/usa)

## Warning

<b>USER MANUAL:</b>	Read and understand this user manual completely before operating the PhoCheck Tiger instrument.
<b>STATIC HAZARDS:</b>	Do not use abrasive or chemical detergents to clean the PhoCheck Tiger instrument as this may reduce the antistatic properties of the materials used, clean it using a damp cloth only.
<b>MATERIAL EXPOSURE:</b>	The PhoCheck Tiger must not be exposed to atmospheres known to have an adverse effect on Thermoplastic polyolefin or Anti-static PC/ABS.
<b>SERVICING:</b>	Do not remove the sensor cover in the hazardous area. No part of the PhoCheck Tiger may be opened in a hazardous area except for replacement of the battery pack. The PhoCheck Tiger must be serviced in a Non Hazardous environment and by Ion Science authorised service centres only. Do not service the instrument live. Remove battery pack before servicing. Substitution of components may impair intrinsic safety.
<b>BATTERY CHARGING:</b>	Charge PhoCheck Tiger and its lithium ion battery packs in a Non Hazardous environment only.
<b>BATTERY REPLACEMENT:</b>	Never replace primary Alkaline battery cells while in a potentially explosive or hazardous location. Use only Industrial by Duracell ID1500 batteries.
<b>BATTERY CONNECTION:</b>	The PhoCheck Tiger's lithium ion and alkaline battery packs have been specially designed to allow connection to the PhoCheck Tiger Instrument while in potentially hazardous atmospheres. Ensure all electrical connections are clean and undamaged before connection. The PhoCheck Tiger instruments ingress protection rating is reduced to IP20 when its battery pack is removed so avoid changing batteries in dusty or wet environments.
<b>BATTERY USE:</b>	Use supplied battery packs only on the PhoCheck Tiger. Never replace primary alkaline battery cells while in a potentially explosive or hazardous location. Use only Industrial by Duracell ID1500 batteries.
<b>FUNCTIONAL TEST:</b>	The PhoCheck Tiger must be functionally checked prior to entering a hazardous area after every occasion when a connection has been made to the USB port. The instrument must complete its start-up routine and display legible readings. If the LCD display fails to show an intelligible and uncorrupted display the instrument must not enter a hazardous area.
<b>USB CONNECTION:</b>	The USB port can only be used in a Non Hazardous environment.
<b>PROBE USE:</b>	When using the Probe part numbers A-861414, A-861413 the Safety rating of the Phocheck Tiger Instrument drops from II 1 G Ex ia IIC T4 Ga to II 1 G Ex ia <a href="#">IIB</a> T4 Ga. The temperature performance of the unit is unaffected.
<b>Proper Use:</b>	If the equipment is used in a manner not specified by the manufacturer, the protection provided by the equipment may be impaired.
<b>Type of safety protection:</b>	Intrinsically safe.

## Avertissement

<b>MODE D'EMPLOI:</b>	Veillez lire entièrement et comprendre ce mode d'emploi avant d'utiliser l'instrument PhoCheck Tiger.
<b>RISQUES LIÉS AUX PROPRIÉTÉS ANTISTATIQUES:</b>	N'utilisez pas de détergents abrasifs ou chimiques pour nettoyer l'instrument PhoCheck Tiger, au risque de réduire les propriétés antistatiques des matériaux utilisés. Employez uniquement un chiffon humide.
<b>EXPOSITION AUX MATÉRIEAUX:</b>	N'exposez pas le PhoCheck Tiger à des atmosphères connues pour avoir un effet indésirable sur la polyoléfine thermoplastique ou le PC/l'ABS antistatique.
<b>ENTRETIEN:</b>	<p>Ne retirez pas le couvercle du capteur dans les zones dangereuses.</p> <p>N'ouvrez aucune partie du PhoCheck Tiger dans une zone dangereuse, sauf pour le remplacement de la batterie. L'entretien du PhoCheck Tiger doit se dérouler dans un environnement non dangereux et être confié uniquement à des centres de service agréés Ion Science.</p> <p>Ne procédez pas à l'entretien de l'instrument lorsqu'il est sous tension. Otez la batterie avant l'entretien.</p> <p>Le remplacement de composants risque de nuire à la sécurité intrinsèque.</p>
<b>CHARGE DE LA BATTERIE:</b>	Chargez le PhoCheck Tiger et sa batterie lithium-ion uniquement dans un environnement non dangereux.
<b>REMPLACEMENT DES PILES:</b>	Ne remplacez jamais de piles alcalines dans un endroit dangereux ou potentiellement explosif. N'utilisez que des piles alcalines Industrial by Duracell ID1500.
<b>CONNEXION DES PILES/DE LA BATTERIE:</b>	Les batteries lithium-ion et les piles alcalines du PhoCheck Tiger ont été spécialement conçues pour permettre la connexion à l'instrument PhoCheck Tiger dans des atmosphères potentiellement dangereuses. Assurez-vous que les connexions électriques sont propres et intactes avant la connexion. L'indice de protection des instruments PhoCheck Tiger étant ramené à IP 20 lors du retrait de la batterie, évitez de remplacer les batteries dans des environnements poussiéreux ou humides.
<b>UTILISATION DES PILES/DE LA BATTERIE:</b>	<p>N'utilisez que les batteries fournies avec le PhoCheck Tiger.</p> <p>Ne remplacez jamais des piles alcalines primaires dans un endroit dangereux ou potentiellement explosif. N'utilisez que des piles alcalines Industrial by Duracell ID1500.</p>
<b>ESSAI DE FONCTIONNEMENT:</b>	Le PhoCheck Tiger doit subir un essai de fonctionnement avant de pénétrer dans une zone dangereuse chaque fois qu'une connexion a été effectuée au port USB. L'instrument doit terminer sa routine de démarrage et afficher des valeurs lisibles. Si l'écran LCD n'affiche pas de données correctes et intelligibles, n'utilisez pas l'instrument dans une zone dangereuse.
<b>CONNEXION USB:</b>	Le port USB peut uniquement être utilisé dans un environnement non dangereux.
<b>UTILISATION DE LA SONDE:</b>	Lors de l'utilisation des pièces de la sonde dont les numéros vont de A-861414, A-861413, la côte de sécurité de l'instrument Phocheck Tiger se réduit de II 1 G Ex ia IIC T4 Ga à II 1 G Ex ia IIB T4 Ga. La performance de la température de l'unité n'est pas affectée".
<b>Utilisation appropriée:</b>	Si l'équipement est utilisé d'une manière non spécifiée par le fabricant, la protection fournie par l'équipement peut être altérée.
<b>Type de protection de sûreté:</b>	Sécurité intrinsèque.

## Contents

<b>1. Safety</b> .....	<b>8</b>
Legal Notices Regarding the Safe Operation of Equipment.....	8
Symbols.....	8
Warnings and Cautions and Information notifications.....	8
Disposal.....	9
<b>2. Product Overview</b> .....	<b>10</b>
Upgrades.....	12
TigerPC Software .....	12
TIGER Kit .....	12
Keypad Function Descriptions .....	13
<b>3. Getting Started</b> .....	<b>14</b>
Fitting the Inlet Probe.....	14
Switching your TIGER On .....	14
Switching your TIGER Off .....	14
Checking the Battery Charge .....	15
Select the Gas .....	15
Set Alarm Levels.....	15
<b>4. Understanding the Display Screen</b> .....	<b>16</b>
Overview.....	16
Status Icons.....	17
Soft Key Options .....	18
<b>5. Using the TIGER</b> .....	<b>19</b>
Turning On / Off.....	19
Turning On .....	19
Turning Off.....	19
Setup Functions .....	19
<b>6. Using the TigerPC Software and Downloading Data</b> .....	<b>24</b>
PC Requirements .....	24
Installation of TigerPC Software .....	24
Connecting a TIGER to a PC .....	24

Opening TigerPC .....	25
Help Screen.....	26
The Instruments List .....	27
Downloading Data Logged Readings and Instrument Settings .....	27
Taking Snapshots .....	29
Instrument Summary Screen .....	30
Features Screen .....	31
Configuration Screen .....	32
Gas Table Screen.....	40
Firmware Screen .....	42
Datalog Screen .....	44
Health & Safety Screen .....	45
Snapshots Screen.....	46
<b>7. Calibration .....</b>	<b>50</b>
Calibration .....	50
Custom Calibration .....	50
<b>8. Maintenance.....</b>	<b>53</b>
TIGER Parts Diagram.....	53
Batteries .....	54
Battery Packs .....	54
Recharging Batteries.....	54
Replacement of Rechargeable Battery Packs .....	55
Replacement of Non-rechargeable Batteries .....	56
Inlet Probe Assembly.....	57
PTFE Filter Disc.....	58
Probe Seal.....	58
Water Ingress.....	58
Lamp Cleaning and Electrode Stack Replacement.....	58
When to Clean or Replace the Lamp .....	58
When to Replace the Electrode Stack.....	59
Removing the MiniPID 2 Sensor .....	59

Lamp Removal and Examination.....	60
Lamp Cleaning.....	60
Replacing a Lamp.....	61
Replacing the MiniPID Electrode Stack.....	62
<b>9. Troubleshooting.....</b>	<b>64</b>
Diagnostics.....	64
<b>10. Appendix and Supporting Documents .....</b>	<b>65</b>
EU Declaration of Conformity.....	65
Technical Specifications.....	65
Warranty.....	67
ION Science Contact Details .....	68
UK and Head Office.....	68
USA Office.....	68
German Office.....	68
Italian Office.....	68
French Office.....	68
Chinese Office.....	68
Indian Office.....	68
Manual Log .....	69

## 1. Safety

### Legal Notices Regarding the Safe Operation of Equipment

- While every attempt is made to ensure the accuracy of the information contained in this manual, ION Science accepts no liability for errors or omissions in the manual, or any consequences deriving from the use of information contained herein. It is provided “as is” and without any representation, term, condition or warranty of any kind, either expressed or implied.
- To the extent permitted by law, ION Science shall not be liable to any person or entity for any loss or damage which may arise from the use of this manual.
- We reserve the right at any time and without any notice to remove, amend or vary any of the content which appears in this manual.

### Symbols



**WARNING!**  
USED TO INDICATE DANGER WARNINGS WHERE THERE IS A RISK OF INJURY OR DEATH.



**Caution**  
Used to indicate a caution where there is a risk of damage to equipment.



**Information**  
Important information or useful hints about usage.



**Recycling**  
Recycle all packaging.



**WEEE Regulations**  
Ensure that waste electrical equipment is disposed of correctly.

### Warnings and Cautions and Information notifications

The following apply to the product described in this manual.



**BATTERY CHARGING: CHARGE THE TIGER AND ITS LITHIUM BATTERY PACKS IN A NON-HAZARDOUS ENVIRONMENT ONLY.**



**The instrument should be used in accordance with the safety standards and installation instructions given in this manual, and in compliance with local safety standards.**





**Responsibility for use:** TIGER instruments detect a large range of gases which are potentially dangerous from both a poisoning and/or an explosive perspective. TIGER instruments have many adjustable and selectable features allowing the instrument to be used in a variety of ways.

ION Science Inc. can accept no responsibility for the incorrect adjustment of features that cause harm or damage to persons or property. TIGER can be used as a personal safety device. It is the user's responsibility to respond appropriately to an alarm situation.



The TIGER must not be exposed to atmospheres known to have an adverse effect on Thermoplastic polyolefin or Anti-static PC/ABS.



The instrument must be serviced in a Non-Hazardous environment and by ION Science Inc. authorized service centers only. Substitution of components may impair intrinsic safety.



Do not service the instrument live; Remove the Battery Pack before servicing.



**Ingress Protection:** Continuous exposure to wet weather conditions should be limited to less than one day and harsh water spray conditions should be avoided.



When using the Probe part numbers A-861414, A-861413 the Safety rating of the TIGER Instrument drops from II 1 G Ex ia IIC T4 Ga to II 1 G Ex ia IIB T4 Ga. The temperature performance of the unit is unaffected.

### Disposal

- The equipment does not include any toxic materials, but if it has been contaminated by toxic materials, then exercise due care and follow the appropriate regulations when disposing.
- Always adhere to local regulations and procedures when disposing of the equipment.



#### RECYCLING

Recycle all Packing.



#### WEEE REGULATIONS

Ensure that all waste electrical equipment is disposed of correctly.



ION Science Inc. offers a take back service. Please contact us for more information.



## 2. Product Overview

The TIGER is a portable gas detector that uses photoionization technology to detect a large range of Volatile Organic Compounds (VOCs) which can be dangerous from both a poisoning and explosive perspective.

The TIGER uses a Photoionization Detector (PID) to measure gas concentrations. The patented fence electrode technology minimizes the effects of moisture and contamination, avoiding the need for compensation.

Survey is the default mode of operation. This mode is often used in applications such as Head Space Sampling and Leak Detection where several areas (or Zones) are to be monitored and readings data logged. All sensor readings are real time measurements and alarm levels are set manually.

Health and Safety mode (optional) is used to check for conformity of short-term exposure levels (STEL) or time-weighted averages (TWA) that are specific for particular hazardous environments (for example EH40 in the UK and OSHA in the USA). In this mode of operation STELs and TWAs are continually calculated and compared to levels set in the instrument's gas table.

The TIGER has an intuitive graphical interface allowing easy access to instrument settings. Two keys **A**  and **B**  can be configured to suit the user's application, so many functions can be selected without entering the main menu structure. This improves efficiency of use, particularly with repeatable tasks.



The TIGER has been designed and certified Intrinsically Safe.



- |                      |                   |
|----------------------|-------------------|
| 1 Charge Cradle      | 5 Display Screen  |
| 2 Instrument Boot    | 6 Keypad          |
| 3 Alarm LEDs / Torch | 7 Instrument Body |
| 4 Probe Assembly     | 8 Battery Pack    |



- |                     |                |
|---------------------|----------------|
| 9 Charging Contacts | 11 Pump Outlet |
|---------------------|----------------|

**10** Sensor Cover**12** USB Port (Type B)

### Upgrades

The following optional features can be purchased either during initial sale, or via remote upgrade post-sale:

- PPB Sensitivity
- Health and Safety
- Single-log Data Logging option
- Multi-log Data Logging option
- Full Data Logging

Refer to the [Features screen](#) for details.

### TigerPC Software

The TigerPC software enables you to fully configure the instrument, view and edit gas tables, and view logged data, including health and safety readings.

We recommend you install the software and set up your TIGER as described in [TigerPC Software](#).

### TIGER Kit

ION Science provides a range of TIGER kits and accessories. The content of a standard kit is:

- TIGER instrument
- Rechargeable Battery (Li-ion) - one per kit\*
- Battery Charge Cradle and Mains Adaptor\*
- Instrument Boot
- TIGER Manual - free download from website
- TIGER Quick Start Guide
- Carbon Filter Assembly
- PTFE Filter Discs
- Removal Tool for MiniPID Stack
- Sample Cleaning Compound
- Calibration Adaptor
- Sensor Seal – coated
- USB Cable

\* Only included with the rechargeable TIGER (see [Battery Packs](#)).

For details of different kits and other accessories, contact [ION Science](#) or your local distributor.

### Keypad Function Descriptions



The functionality of the **A** and **B** keys varies. Prompts on the display indicate their functionality at a given time.



The **Up** and **Down** keys are used to adjust settings and navigate through the menu structure.



The **Esc** (Escape) key is used to cancel a change or exit a menu.



The **Enter / On / Off** key is used to accept changes, select functions, and to turn the TIGER on and off.

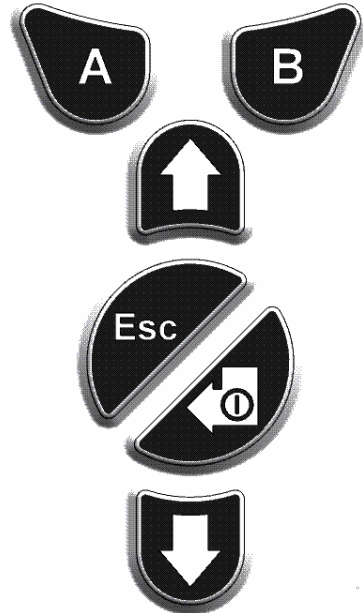

In general, setup and application settings are selected and adjusted using the soft keys. Options are selected using the arrow keys and confirmed using the **Enter** key or a soft key.

A continuous press is used to scroll through options and numbers, e.g. to change the gas selection by scrolling through the available selections until the required gas selection is displayed.

### 3. Getting Started

#### Fitting the Inlet Probe

Ensure that the inlet probe supplied is fitted to your TIGER

#### Switching your TIGER On

Press the **Enter / On / Off** key once to turn TIGER On.



The lights will flash white, red, then amber, and a “beep” will sound. You should also be able to hear the pump start operating.

The display will initially display the ION Science logo. It will then display a screen showing the ID of the instrument, as entered in the Instrument ID in TigerPC, and the firmware version installed on it.

The display will then show the instrument checking that the Lamp is working (the  symbol is displayed).

Next, [if the instrument is set to Zero when switched on](#), the screen will display the  symbol.

The main running screen is then displayed:



Your instrument is now ready to use.

#### Switching your TIGER Off

Press and hold the **Enter / On / Off** key for 3 seconds to turn TIGER Off. A 3-second countdown will be displayed on the screen. While this is happening, a continuous beep will sound, and the lights will flash red.

Once the instrument is switched off, wait a few seconds before switching on again.

## Checking the Battery Charge

Check that your TIGER has sufficient charge for use. The battery icon (see [Batteries](#)) should show at least two full segments. If not, the instrument should be charged to at least this level before use.



TIGER instruments leave the factory with their Rechargeable Battery Pack fully charged. However, prolonged periods of storage may result in the Rechargeable Battery Pack discharging. We recommend charging the instrument for seven hours before first use.

A non-rechargeable AA Battery Pack can also be used, but it is recommended that it only be used if no power is available to recharge the Rechargeable Battery Pack.

For further details of Battery Packs and recharging, refer to [Batteries](#).

## Select the Gas

Next, ensure that the instrument is set to detect the correct gas. This is displayed on the main running screen above the current measurement units.



TIGER instruments leave ION Science pre-set for gas type isobutylene. Instruments are factory calibrated against isobutylene and all response factors are equivalent to this. By changing the gas from the internal gas table all readings will be given using that gas's response factor.

Press the **Information**  soft key and check the correct gas alarms are selected.

If necessary, change the selected gas. This can be done [using TigerPC](#), or [using the instrument](#).

## Set Alarm Levels

We recommend that alarm levels are set to user specifications as soon as possible before the TIGER is first used. See [Alarms](#) for details.

## 4. Understanding the Display Screen



**IF AN ALARM STATE IS TRIGGERED THE USER SHOULD LEAVE THE HAZARDOUS ENVIRONMENT AND ACT IN ACCORDANCE WITH NATIONAL SAFETY REGULATIONS.**

### Overview

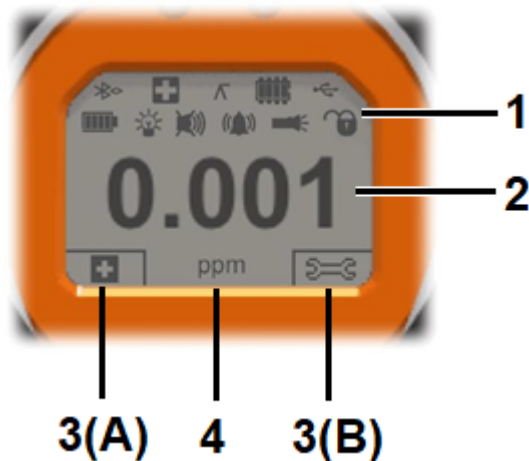

The display screen is divided into four sections:

1. The top of the screen shows fixed LCD status icons indicating instrument status at a glance. The icons display only when a function is selected.
2. The main screen area displays numerical readings in four large numbers during normal operation (i.e. when the central running screen is displayed). During setup and adjustment, a function bar overlays the display.
3. The bottom left and right areas of the screen display the two soft key indicators, i.e. which particular functions are currently associated with the **A** and **B** keys.
4. The area between the two soft key indicators displays the measurement units and the gas that the instrument is currently set to detect.



The TIGER instrument auto-ranges, therefore the number of decimal places reduce as the VOC reading increases. The minimum achievable sensitivity is 0.001 ppm, the maximum is 19,999 ppm. When the maximum range is exceeded the display will show '99999'.



## Status Icons



**Health and Safety:** This will flash in an alarm condition and (if the instrument has the Health and Safety [upgrade](#)) when [health and safety readings](#) are being collected.



**Peak Hold:** This is displayed when peak hold is on.



**Memory Status:** Only displayed if the instrument has the [Data Logging upgrade](#). Four sections within the border fill as the data log memory is filled.

Empty border = 100% memory available through to full, where all segments are present. The icon fills as data log memory is filled. It will flash when multi-logging is activated.



**USB:** This is displayed when the instrument is connected to a PC.



**Battery Status:** A standard [battery charge](#) indicator.

When the battery is nearly discharged, the final segment flashes for one minute before the instrument shuts down.



**Backlight:** Light beam lines appear when the backlight is on.



**Sound:** The top icon is displayed if all three alarm sounders are off and the volume is set to 0%.

Otherwise, zero to three sound projection lines are displayed to indicate the volume level (there are four sound levels; no line is displayed for the quietest).



**Alarm Bell:** When a 'Low alarm' is triggered, the bell symbol and one curved line on either side of the bell symbol will flash.

When a 'High alarm' is triggered the bell symbol and two curved lines on either side of the bell symbol will flash.



**Flashlight / Torch:** This is displayed when the flashlight/torch is turned on by pressing the **A** and **B** keys simultaneously.



**Lock:** The lock icon is displayed when the configuration of the TIGER has been locked in TigerPC.

Options associated with soft key **A** are enabled.









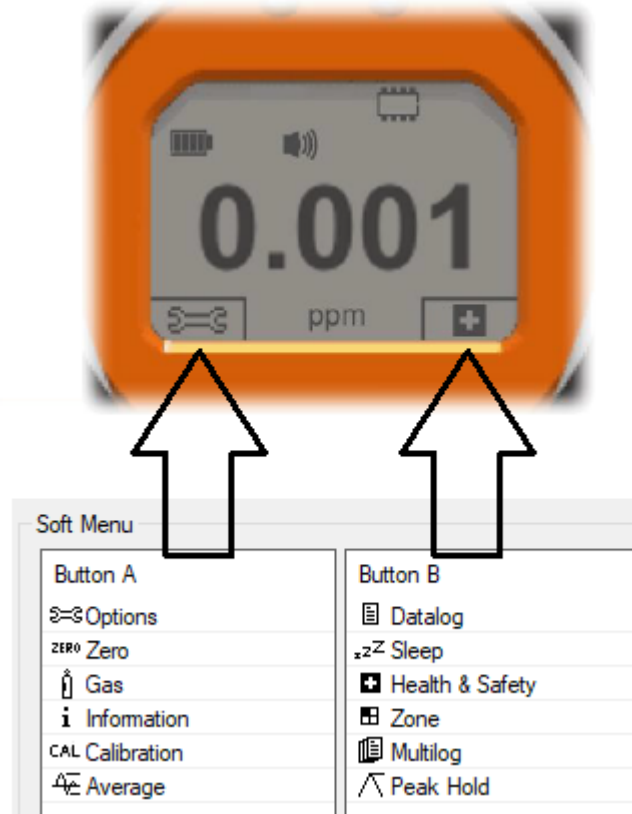

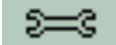

Options associated with soft key **B** are disabled.

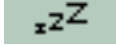
### Soft Key Options

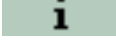
The following icons are displayed in the soft key areas as soft key options. They are selected using the **Up** and **Down** keys. Those labelled ‘optional’ will only appear if your TIGER has that functionality.

These icons can be reorganised or hidden using the Tiger PC software. Refer to the [Configuration](#) section of Tiger PC for details.

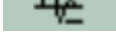

Key 	Key 
 Options	 Data Log (optional)
 Zeroing	 Sleep
 Gas Selection	 Health and Safety (optional)
 Information	 Zone(s)
 Calibration	 Multiple Data Log (optional)
 Average	 Peak Hold
	 Stealth (not pictured)

## 5. Using the TIGER

Instrument functionality is split into two parts; Application and Setup. Application settings are initially selected via the keys **A** and **B**. Setup functions like Backlight, Sound, Calibration and Alarm Setting are adjusted within **Options**. Many of the screens have a 2 second time-out which returns to the main screen if no other keys are pressed.

### Turning On / Off

#### Turning On

To switch the TIGER on press the **Enter / On / Off** key once. The device will display logo and info screens during the start-up sequence.

The device will then zero before displaying the main running screen. We encourage users to leave the device running for 10 to 15 minutes prior to use. The TIGER is now ready to use.



#### Turning Off

To switch the TIGER off press and hold the Enter/ On / Off key. A three second count down takes place before the instrument shuts down. During this count down the instrument activates the upper alarm, visual red LED's flash and audible alarm sounds. This is done to alert the user to avoid accidental switch off.

### Setup Functions

#### Calibration

When selected, the user is presented with two options:

-  **Factory:** You can set your instrument to operate using the factory calibrated values. These are set by ION Science Inc. or authorized service centers
-  **Custom** You can carry out a Custom Calibration with the 10.0eV, 10.6eV or 11.7eV Mini PID. Custom calibration should be carried out as part of regular instrument maintenance.
-  **Zero:** This option is used to set the instrument either to the selected calibration Zero (Absolute Mode), or to Zero against the ambient (Relative Mode):



**Absolute Mode** uses fixed calibration Zero (either Factory or Custom Calibration).





**Relative Mode** sets the Zero level to the ambient.

Refer to [Calibration](#) for details of calibration procedures.

**Options** 

The **Options** soft key accesses several instrument settings. These can also be configured using:

- Time and Date** 



To adjust the time and date via the instrument, use the **Up** and **Down** keys to select the date or time and press **Enter**. Then use the **Up** and **Down** keys to adjust the values, as required. Confirm settings with **Enter**.
- Backlight** 

Refer to the [TigerPC Configuration Screen](#) topic for details of these options. Select the preferred option with the **Up** and **Down** keys and confirm with **Enter**. Note that if the limited time option is selected, the time is set using TigerPC.
- Sound** 

Refer to the [TigerPC Configuration Screen](#) topic for details of these options. Select the preferred option with the **Up** and **Down** keys and confirm with **Enter**.

For percentage volume, press **Enter** again to confirm selection. The frame will flash. Use the **Up** and **Down** keys to change the percentage volume and press **Enter** to confirm the chosen value.
- Alarms** 

Upper and lower alarms levels for the selected gas are taken from gas tables. They can be [changed using TigerPC](#), or via this option.

Upper  and lower  alarm options are displayed. Select an alarm using the **Up** and **Down** keys and press **Enter**. The arrow(s) on the chosen alarm will flash. Adjust the level using the **Up** and **Down** keys and press **Enter**. Repeat if necessary for the other alarm.



The lower alarm setting should never be greater than the upper alarm. Therefore, if the lower alarm is set to higher than the upper alarm, the upper alarm is automatically incremented to the lower alarm level plus 1.

- Units** 

Refer to the [TigerPC Configuration Screen](#) topic for details of these options. Select from the available units by using the **Up** and **Down** keys and then pressing **Enter**.

**Zeroing** 

Pressing the **Zero** soft key presents two Zero options . Use the **Up** or **Down** keys to select them. The upper symbol represents an absolute Zero. The lower symbol represents a relative Zero, which follows the drift of the MiniPID 2 Sensor.





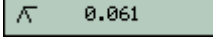





The screen displays a tick '✓' to confirm your selection. If the relative Zero has been selected, TIGER will then Zero itself.

**Peak Hold** 

Press the **Peak Hold** soft key to display the peak reading . This reading will stay on screen, updating as the current peak reading changes. Press the **Reset** soft key to reset the peak value. Press **Esc** to cancel.

**Information** 

Pressing the **Information** soft key provides access to a list of screens which display the current settings of the TIGER. Use the **Up** and **Down** keys to scroll through the list and press **Enter** to view a screen. Press **Esc** to return to the main running screen.

<b>First screen</b>	Gas selected	
	Response Factor	RF
	Upper alarm	
	Lower alarm	
	Run Time	Run Time: 0:00
<b>Second screen</b>	Lamp selected	
	Date of Factory Calibration	
	Date of Custom Calibration	
	Date of Select tube calibration (optional)	
<b>Third screen</b>	SPAN 1	SPAN 1
	SPAN 2	SPAN 2
	PID detector in units	PID
	MiniPID 2 Sensor PID Sensor A/D reading	A/D
<b>Fourth screen</b>	Short Term Exposure Levels (optional)	STEL
	Time Weighted Average (optional)	TWA
	Internal Reference Number	IRN:
	Firmware version	Firmware:
	Bootloader version	Bootloader:
	Battery type and voltage	
<b>Fifth screen</b>	Memory available	
	Gas Table Date	
	Date and time	

**Sixth screen**

Features\* - an icon will appear for each feature available

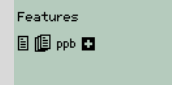

\* Refer to the [Features screen](#) for details of these optional upgrades.

**Gas Selection**

Press the **Gas Selection** soft key to display an alphabetical letter which can be changed using the **Up** and **Down** keys: Press the **Enter** key to list the gases beginning with that letter. Using the **Up** and **Down** keys scroll through the gases starting with that letter to find the subject gas. Press **Enter** to select the chosen gas. If a tick '✓' appears, press **Enter** again, and TIGER will use the relevant data for the selected gas from the gas table for alarms, response factor, etc.

If the selected gas has no numeric response factor, or is incompatible with the lamp selected, a warning symbol will appear. The message can be cleared by pressing the **Enter** key. The gas will still be selected. An alternative lamp type may then be selected to match the chosen gas. If an incompatible gas/lamp combination is selected the instrument will show the warning symbol again.

**Average**

Press the **Average** soft key to display a rolling average over 10 seconds (the user can change this time in [Tiger PC](#)). A tick '✓' appears when time is up. Pressing the **Reset** soft key resets the calculation even if there is an average already running. Press **Esc** to cancel.

**Health & Safety**

Optional, only available if the relevant [upgrade has been installed](#).

Press the **Health & Safety** soft key to display the Health & Safety symbol with a question mark to ask if the user wishes to proceed. Press **Enter** to confirm and start the calculations. The [Health & Safety icon](#) will flash.

The STEL and TWA values are then shown. To stop calculations, press **Enter**. A question mark is then displayed. Press **Enter** again to confirm that calculations are to be stopped. A tick '✓' then appears beside the question mark, and then main running screen is displayed.

While the instrument calculates the instrument displays the ongoing STEL as it is calculated. The live reading is for indication only. Only the final reading at the end of the process is logged and should be used as reference.

If a gas has no STEL and TWA levels in the gas table this symbol will appear:

**Zones**

Press the **Zone** soft key to display the name of the currently selected Zone: The TIGER default is '001'. [Zones are set up in TigerPC](#). Use the **Up** and **Down** keys to select other zones.

### Data Logging: Single-log (push-to-log)

Option only available if the relevant [upgrade has been installed](#).

Press the **Single Data Log** soft key to take a single data log reading. The Single Data Log symbol appears briefly with a tick  before returning to the main screen. Press **Esc** to return to the main screen. Press the **Single Data Log** soft key again to take another reading. The [memory status icon](#) flashes when a single data log reading is taken.

### Data Logging: Multi-logging

Optional, only available if the relevant [upgrade has been installed](#).

Pressing the **Multi Data Log** soft key results in the Multi-logging symbol appearing with a question mark: . Press the **Enter** key to start the Data Logging process based on [TigerPC setup](#). A tick '✓' briefly appears beside the question mark to confirm that Data Logging has started. The [memory status icon](#) flashes once per second while continuous Data Logging is in progress. Press **Esc** to return to the main screen.

To stop Data Logging, press the soft key again. A crossed-out data log symbol is then displayed next to a question mark. Press the **Enter** key to confirm the action. A tick '✓' then appears beside the question mark, confirming that Data Logging has stopped.

### Sleep Mode

Press and hold the **Zzz** soft key to send the TIGER to “sleep”. A three second count down takes place before it enters Sleep Mode. All functionality is switched off. “Zzz” is displayed on screen. Press **Esc** to cancel.

Sleep Mode is not available when the instrument is locked.

If set to do so in TigerPC, the instrument can also enter Sleep Mode [during data logging when the duration between logs exceeds two minutes](#), and [automatically when connected to a PC](#). This is a power saving function.

### Stealth Mode

By default, this option is not available via either soft key. Assign it to a soft key menu [using TigerPC](#).

When selected, all audible and visual alarms are disabled except for the alarm indicator on the screen. This function may help avoid triggering panic in public places.

## 6. Using the TigerPC Software and Downloading Data

The TigerPC software enables you to fully configure the instrument, view and edit gas tables, and view logged data, including health and safety readings.

### PC Requirements

TigerPC Software must be used in conjunction with a PC or laptop using Windows 10.

### Installation of TigerPC Software

Download the TigerPC software from the ION Science website:

[www.ionscience.com/usa](http://www.ionscience.com/usa)

Run setup.exe to install the software.

Alternatively, the TigerPC software can be purchased on a memory stick.

Follow the prompts until the installation is complete. Should you have difficulty, please contact your local distributor, or contact ION Science directly:

[www.ionscience.com/usa](http://www.ionscience.com/usa)

### Connecting a TIGER to a PC



**The TIGER must be functionally checked prior to entering a hazardous area after every occasion when a connection has been made to the USB port. The instrument must complete its start-up routine and display legible readings. If the LCD display fails to show an intelligible and uncorrupted display the instrument must not enter a hazardous area.**

Connect your TIGER to the PC. The (type B) USB port of the TIGER is located at the back of the instrument, above the charging connectors. A flap on the Instrument Boot can be opened to reveal it.

While the TIGER is connected, the instrument will go into Sleep Mode [if set to do so in TigerPC](#). The instrument will “awaken” when it is disconnected.



## Opening TigerPC

Before opening TigerPC, connect your TIGER to the PC.

Double-click the Tiger icon on your desktop or in the Start menu to open TigerPC (or run Tiger.exe in the installation folder). The Home page will be displayed:

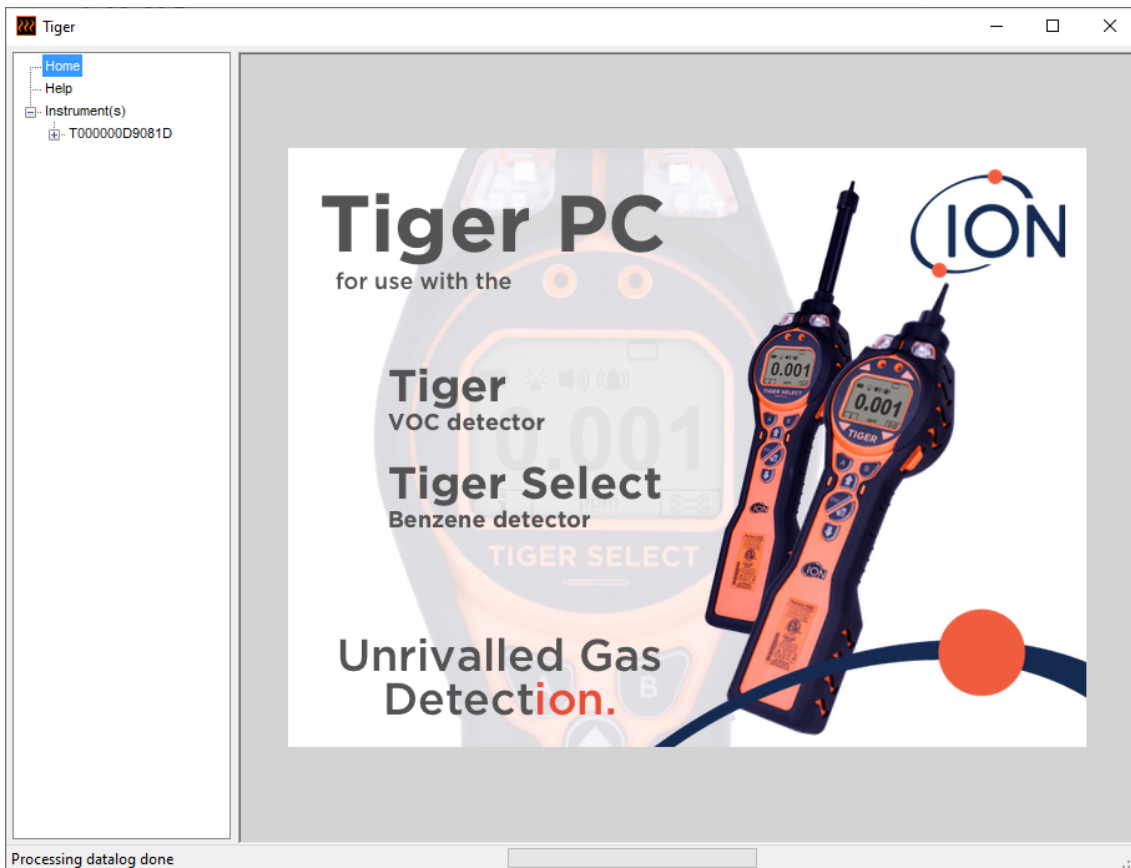

The menu on the left-hand side is used to select further screens.

### Help Screen

This screen will inform you if a new version of PC software is available. You can then install the upgrade if required. We recommend that TigerPC is kept up to date to ensure that the latest functionality is available to you.

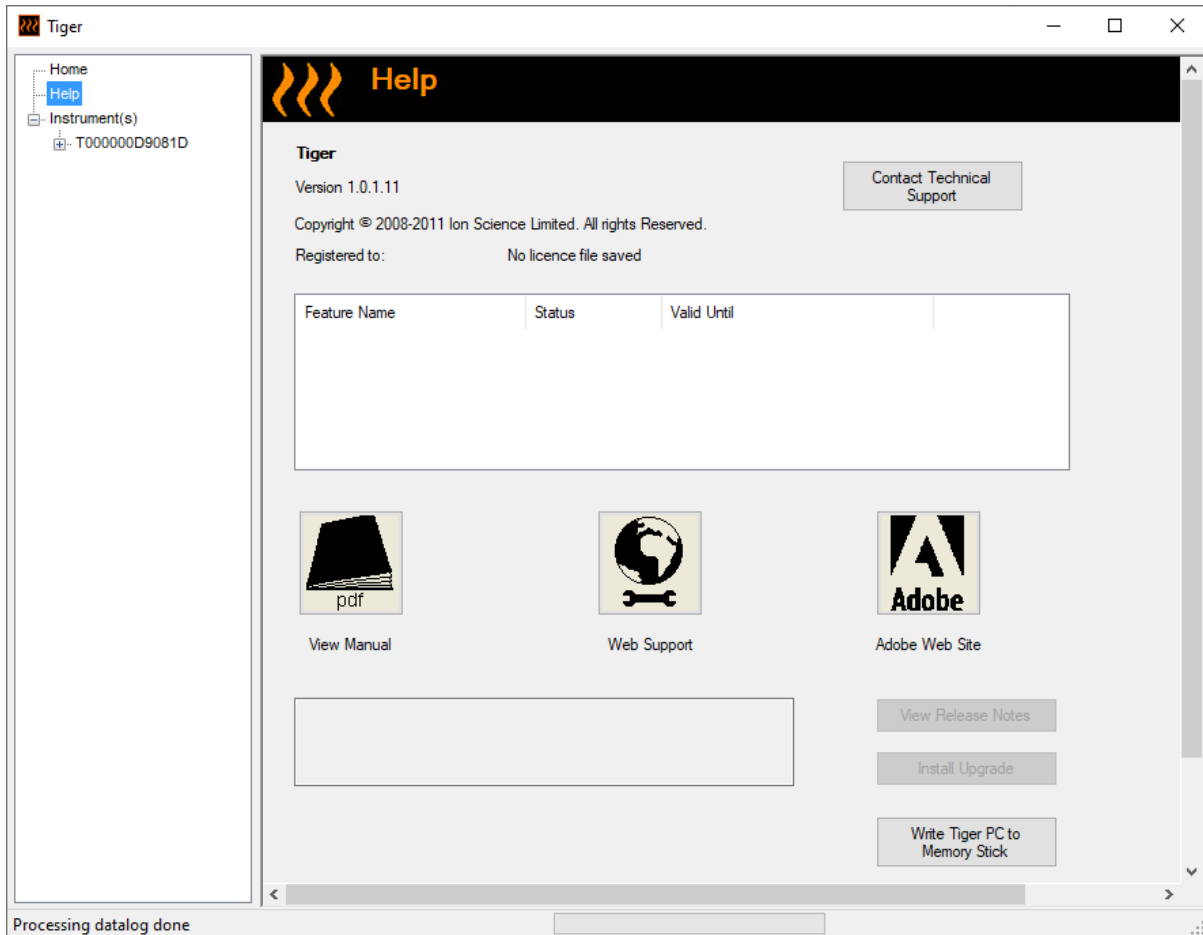

To install an upgrade, press **Install Upgrade**. The following are then displayed:

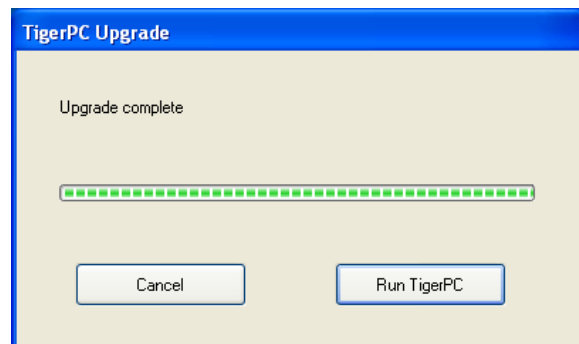
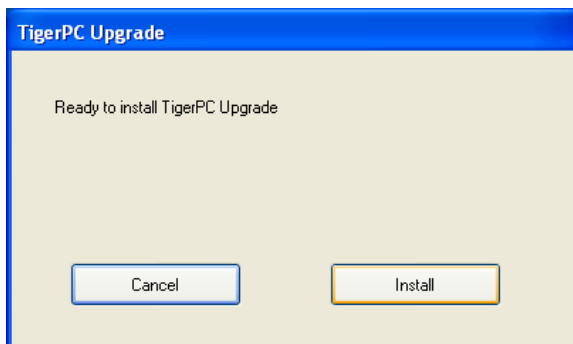

## The Instruments List

The **Instrument(s)** list in the menu lists the Internal Reference Numbers (IRNs) of the TIGER instruments that TigerPC has previously interfaced with and listed. Your instrument will be added to this list once TigerPC has “read” it, as described next.

### Downloading Data Logged Readings and Instrument Settings

Click **Instrument(s)**. The page that is then displayed lists the instruments that TigerPC has previously listed.

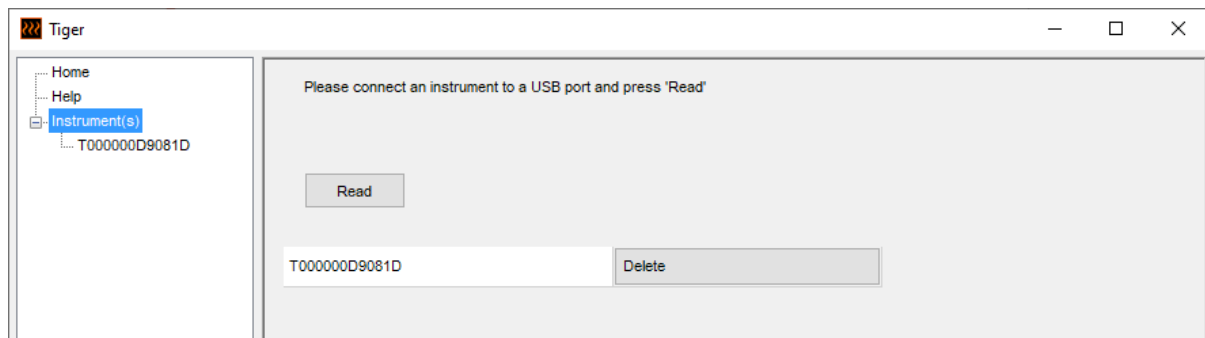

To download data from the connected instrument (and to add it to the instrument list if it hasn't been listed with TigerPC before) click **Read**.

The current setup of the instrument and logged data is then downloaded:

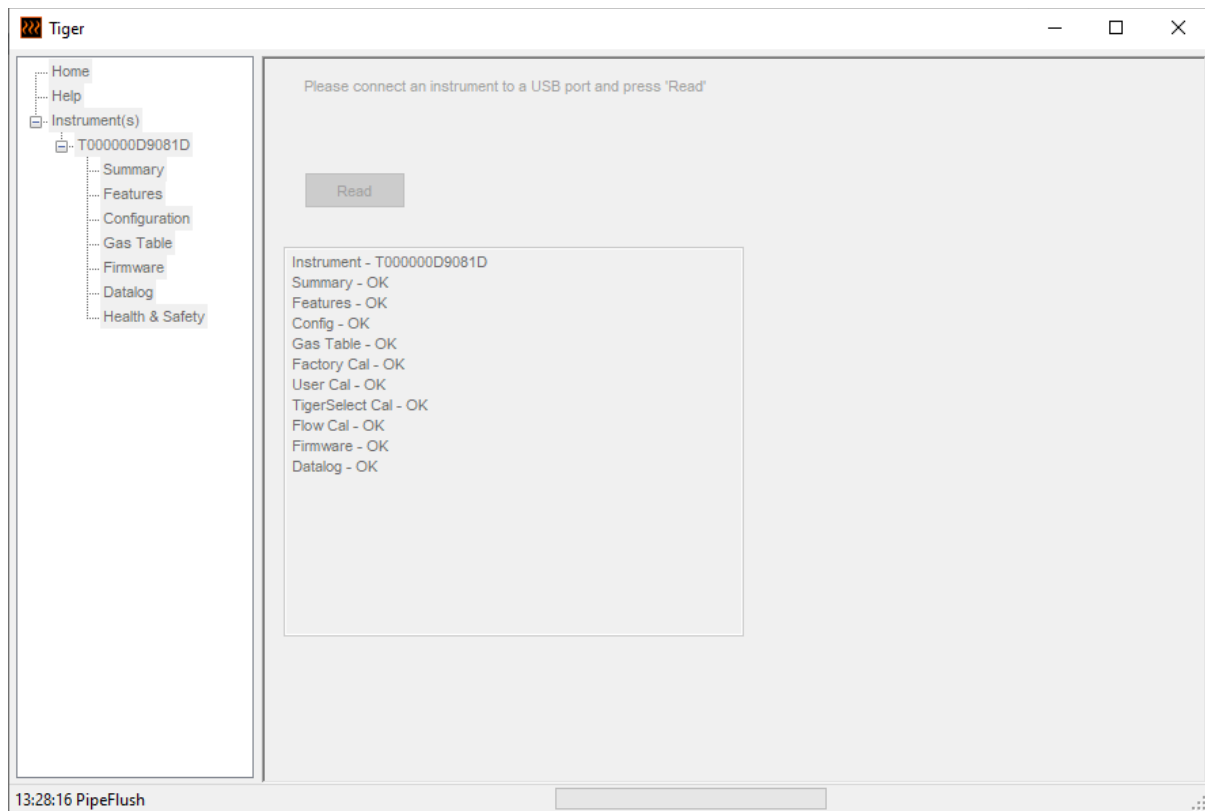

To remove an instrument from the list, click **Delete**. All details of the instrument are then removed from the software. If that instrument is connected again, it will be treated as a new (previously unlisted) instrument by TigerPC.

If not already listed, the instrument IRN will be added to the list of instruments.

### Taking Snapshots

The first time you “read” an instrument a snapshot is taken automatically (see [Snapshots Screen](#)). On subsequent occasions this pop-up is displayed:

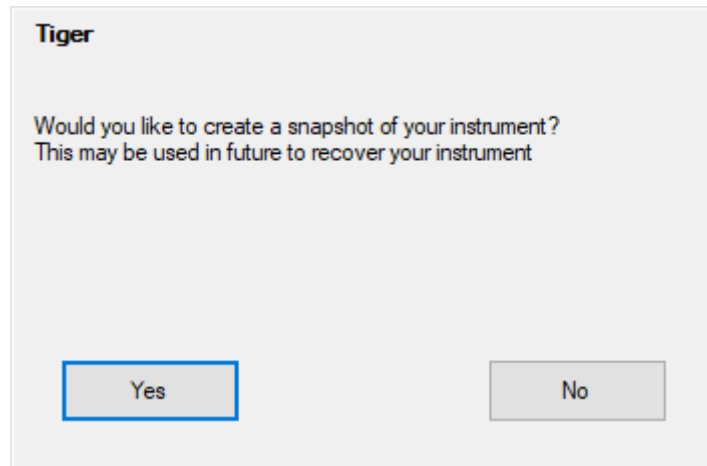

Click **Yes** or **No** as required.

To take a snapshot of a connected instrument at any time, click on the IRN of the instrument in the **Instrument(s)** list, then click **Take Snapshot** on the screen that is then displayed.

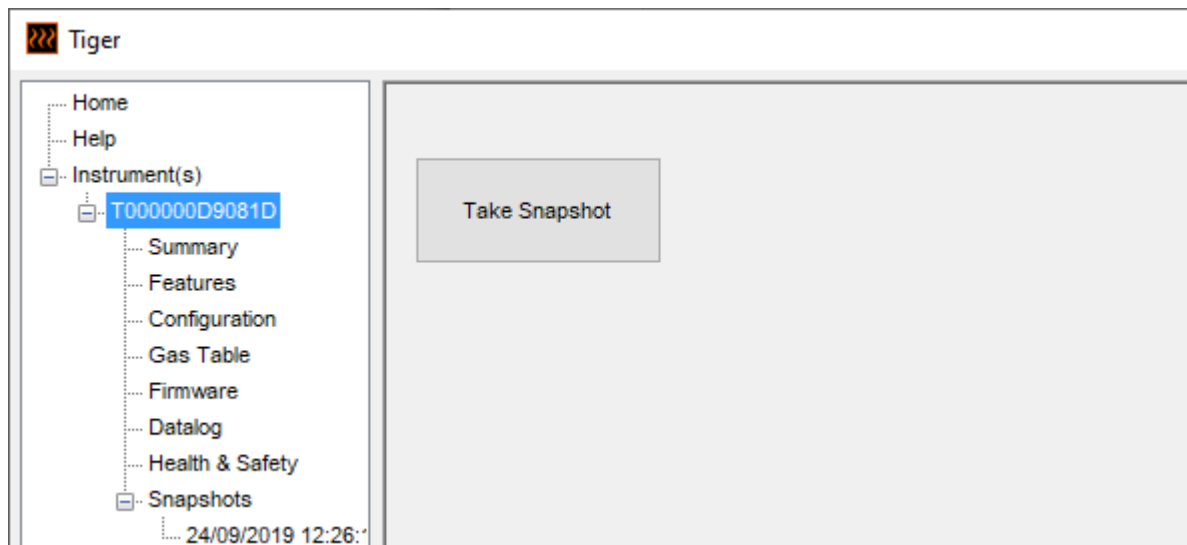

### Instrument Summary Screen

Once an instrument has been read, expand its entry in the menu and click on **Summary** to display the [Instrument Summary screen](#). This screen shows the current status and properties of your TIGER.

Instrument Summary  
T0000010BAA1B

<p>IRN <span style="float: right;">T0000010BAA1B</span></p> <p>Instrument ID <span style="float: right;">TESTA</span></p> <p>Run Time <span style="float: right;">164 hours 26 minutes</span></p> <p>Type Of Lamp Selected <span style="float: right;">10.0</span></p>  <p>Firmware Version <span style="float: right;">V0.8.13</span></p> <p>Datalog Used <span style="float: right;"><div style="width: 100%; height: 10px; background-color: #ccc; border: 1px solid #ccc;"></div></span></p> <p>File System Remaining <span style="float: right;"><div style="width: 100%; height: 10px; background-color: #008000; border: 1px solid #008000;"></div></span></p>  <p>Clock <span style="float: right;">26/02/2020 09:24:12</span></p>	<div style="border: 1px solid #ccc; padding: 5px; margin-bottom: 10px;"> <p><b>Factory Calibration</b></p> <p>Calibration Date <span style="float: right;">14/01/2020 13:57:21</span></p> <table style="width: 100%; border-collapse: collapse;"> <thead> <tr> <th></th> <th style="text-align: center;">Low Gain</th> <th style="text-align: center;">High Gain</th> </tr> </thead> <tbody> <tr> <td>Zero A/D Reading</td> <td style="text-align: center;">310264</td> <td style="text-align: center;">308525</td> </tr> <tr> <td>101.4 ppm A/D Reading</td> <td style="text-align: center;">797178</td> <td style="text-align: center;">13476852</td> </tr> <tr> <td>990 ppm A/D Reading</td> <td style="text-align: center;">4195938</td> <td></td> </tr> </tbody> </table> </div> <div style="border: 1px solid #ccc; padding: 5px; margin-bottom: 10px;"> <p><b>Custom Calibration</b></p> <p>Calibration Date <span style="float: right;">16/12/2019 10:57:11</span></p> <p>Gas Selected <span style="float: right;">Isobutylene</span></p> <table style="width: 100%; border-collapse: collapse;"> <thead> <tr> <th></th> <th style="text-align: center;">Low Gain</th> <th style="text-align: center;">High Gain</th> </tr> </thead> <tbody> <tr> <td>Zero A/D Reading</td> <td style="text-align: center;">303308</td> <td style="text-align: center;">346718</td> </tr> <tr> <td>101.4 ppm A/D Reading</td> <td style="text-align: center;">303379</td> <td style="text-align: center;">352338</td> </tr> <tr> <td>1003 ppm A/D Reading</td> <td style="text-align: center;">303386</td> <td></td> </tr> </tbody> </table> </div> <div style="border: 1px solid #ccc; padding: 5px;"> <p><b>TigerSelect Calibration</b></p> <p>Calibration Date</p> <p>Gas Selected</p> <table style="width: 100%; border-collapse: collapse;"> <thead> <tr> <th></th> <th style="text-align: center;">Low Gain</th> <th style="text-align: center;">High Gain</th> </tr> </thead> <tbody> <tr> <td>Zero A/D Reading</td> <td></td> <td></td> </tr> <tr> <td>ppm A/D Reading</td> <td></td> <td></td> </tr> </tbody> </table> </div>		Low Gain	High Gain	Zero A/D Reading	310264	308525	101.4 ppm A/D Reading	797178	13476852	990 ppm A/D Reading	4195938			Low Gain	High Gain	Zero A/D Reading	303308	346718	101.4 ppm A/D Reading	303379	352338	1003 ppm A/D Reading	303386			Low Gain	High Gain	Zero A/D Reading			ppm A/D Reading		
	Low Gain	High Gain																																
Zero A/D Reading	310264	308525																																
101.4 ppm A/D Reading	797178	13476852																																
990 ppm A/D Reading	4195938																																	
	Low Gain	High Gain																																
Zero A/D Reading	303308	346718																																
101.4 ppm A/D Reading	303379	352338																																
1003 ppm A/D Reading	303386																																	
	Low Gain	High Gain																																
Zero A/D Reading																																		
ppm A/D Reading																																		

## Features Screen

This screen indicates which of the available feature upgrades have been added to your TIGER.

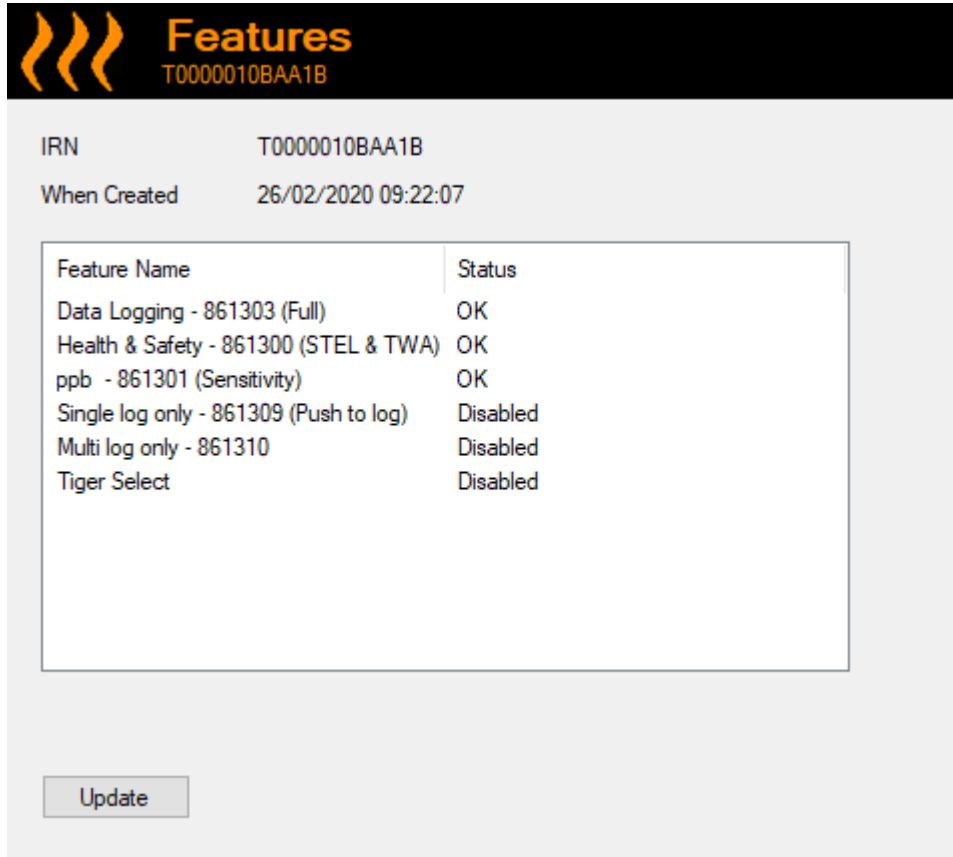

Feature Name	Status
Data Logging - 861303 (Full)	OK
Health & Safety - 861300 (STEL & TWA)	OK
ppb - 861301 (Sensitivity)	OK
Single log only - 861309 (Push to log)	Disabled
Multi log only - 861310	Disabled
Tiger Select	Disabled



Update

To purchase additional features, contact ION Science Inc. or your distributor. Once the transaction is completed and confirmed, click **Update** to install the features on your TIGER.

### Configuration Screen

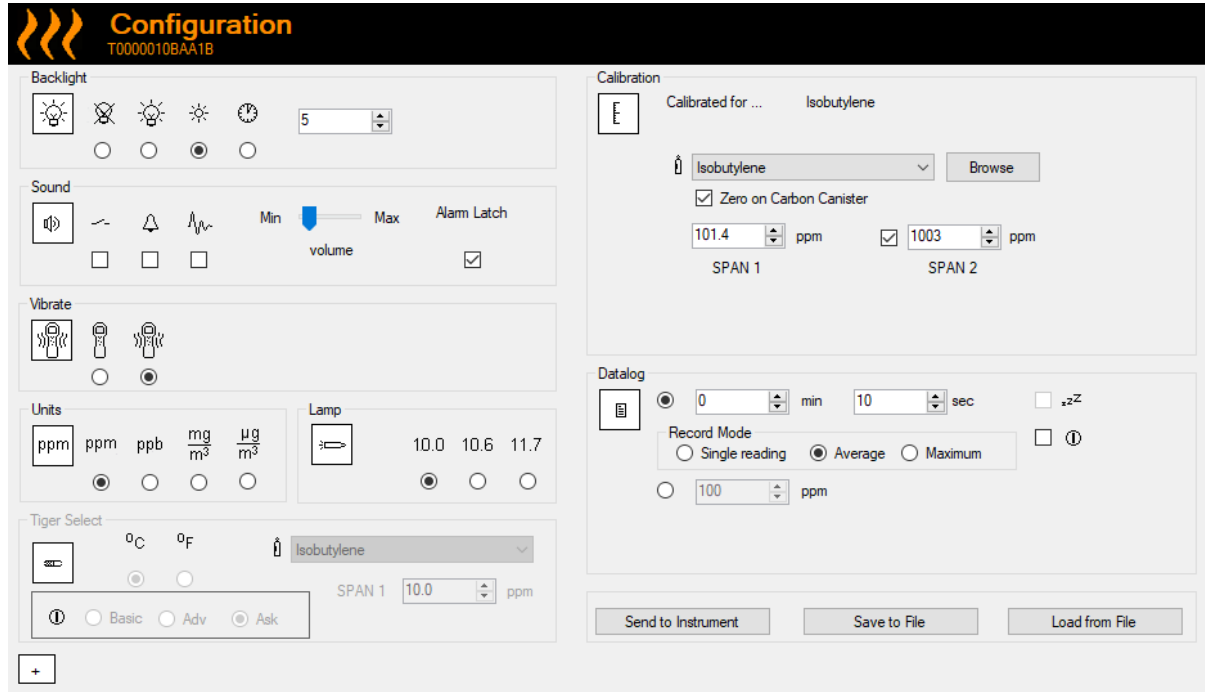
Use this screen to configure your TIGER.



 /  Click these buttons (highlighted above) to display or hide additional settings:



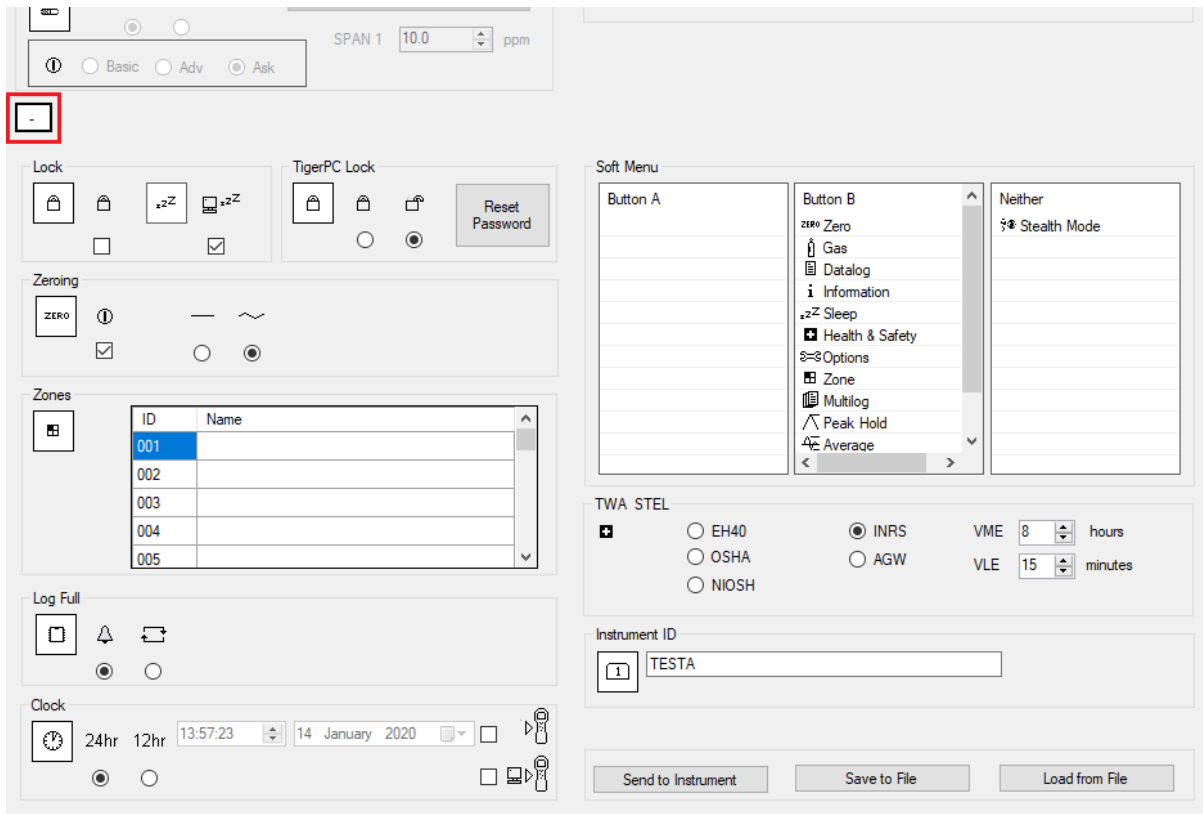

Note that the images in this topic display the default TigerPC settings.

### Backlight

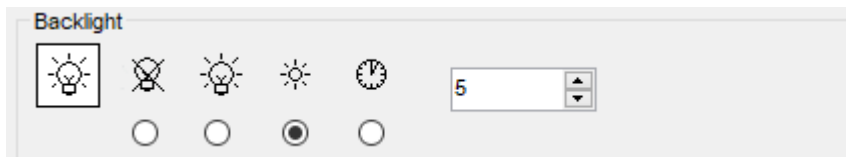

Choose from:

- Permanently off
- Permanently on
- On in low ambient light
- On for limited time

Enter time for the limited time option in the field provided (1 - 99 seconds).

**Sound**



The following options are available:

- Key press sounds
- Audible alarms
- “Crescendo”, i.e. the volume of the low-level alarm sound increases as the upper alarm level is approached
- **Alarm Latch:** alarms continue to sound, even if the gas level falls below the threshold, until the **Esc** key is pressed. If **Alarm Latch** is not set, user set alarms conditions are triggered and reset based on the alarm thresholds in the user settings.

Volume is adjusted using the slider.

**Vibrate**

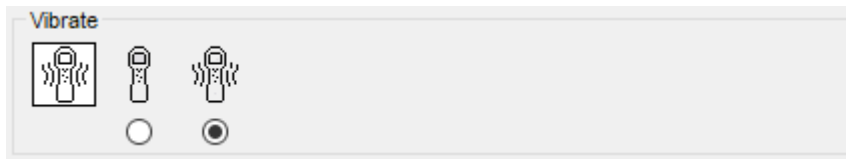

Use to set your TIGER to vibrate under alarm conditions.

**Units**



Choose from parts per million (ppm) or milligrams per meter cubed ( $\text{mg}/\text{m}^3$ ).

If you have the [high sensitivity upgrade](#), then parts per billion (ppb) and micrograms per meter cubed ( $\mu\text{g}/\text{m}^3$ ) are also available.



When the ppb Mode is selected, the instrument over ranges at 9999 ppb (1 ppm).

**Lamp**



Enables the selection of different lamp types you may have purchased to use with your instrument. Ensure that the lamp selected is the same as that fitted in your TIGER. If not, select the correct lamp from the options provided.

**If you have purchased the instrument with the MiniPID 2 Lamp (Argon) 11.7eV (LA4TM700), please take the following into consideration before using the lamp:**

1. It is important for the lamps to be stored in their desiccated vials in cool conditions (15-25°C).
2. The lamps should not be used in:
  - Chemically severe environments, i.e. those containing significant concentrations of acids and strong solvents such as dichloromethane.
  - Conditions of condensing humidity; always pass dry cool air through the instrument before storage. For long storage periods, remove the lamp and return it to the desiccated vial.
  - Physically severe environments: large temperature changes may initiate lamp failure.



11.7 eV lamps may not strike / illuminate first time, resulting in a 'lamp fail' alarm on the TIGER instrument, particularly if the lamps are unused for an extended period. In case of a lamp fail alarm, please switch the instrument off and then on again. Several start cycles may be required.

11.7 eV lamps have a relatively short life partly due to the type of lamp window material. Prolonged exposure to airborne moisture slowly degrades the lamp window. The lamps should therefore be removed from the TIGER and stored in their desiccated vial when not in use.

11.7 eV lamps have quite different characteristics to the standard 10.6 eV lamps.

**Calibration**

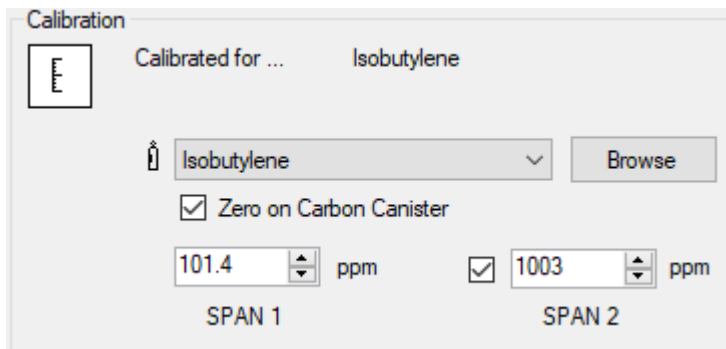

Select the calibration gas using the drop-down list.

If no gases are shown in the drop-down list, click **Browse** and go to the location where the TigerPC software files are saved:

*<Installation folder>/IonScience/Tiger/software/instruments/<instrument number>/gas table*

Find the appropriate gas table and open it.

If required, tick **Zero on Carbon Canister** to ensure a near Zero reading after calibration. The [fixed Zero option](#)  should also be selected.

TigerPC offers two-point (Zero + SPAN 1) and three-point (Zero + SPAN 1 + SPAN 2) calibration options:

- For two-point calibration, enter the SPAN 1 concentration and ensure that the SPAN 2 checkbox is unticked.
- For three-point calibration, tick the checkbox and enter the SPAN 1 and SPAN 2 concentrations.



In applications where the detected gas levels are expected to be below 100 ppm then only a two-point calibration (i.e. Zero and 100 ppm) is necessary. However, in applications that require measurement above 100 ppm a three-point calibration (i.e. Zero, 100 ppm and 1,000 ppm) should be carried out.

Select [Send to instrument](#) to save these settings to your TIGER.

The calibration procedure is detailed in [Calibration](#).

### Datalog

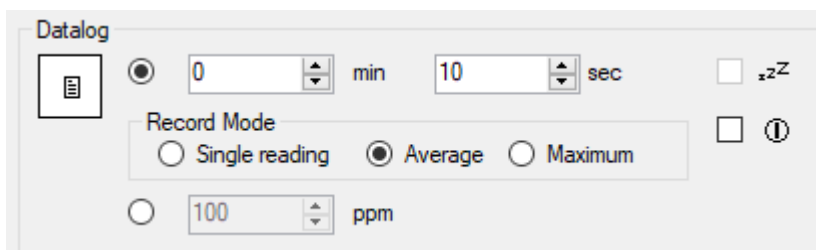

Select one of the following:

- **min** and **sec**: set the interval between readings. Users can select to record each live data points (single), or the average or maximum value between the desired sampling frequency. Must be at least 1 second.
- **ppm**: the instrument starts data logging at 1 second intervals for as long as the ppm gas level is exceeded.

Other options:

- Available only if the interval is over 2 minutes. When selected, the instrument will sleep between logs to preserve battery life.
- The instrument starts data logging when it is switched on.

**TigerPC Lock**

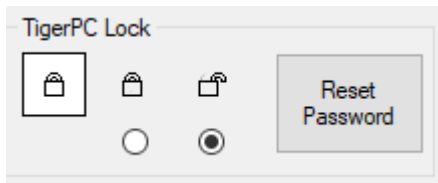

TigerPC can be locked by a master-user to prevent unauthorized adjustment of configuration or settings.

- To lock TigerPC, select the Lock option and enter your password. The default password for TigerPC is 0000. The password can be changed using the Reset Password button.
- If you forget your password, please contact ION Science so that a master password can be issued to you. Master passwords are generated daily and are only valid on the day of generation.

**Lock**

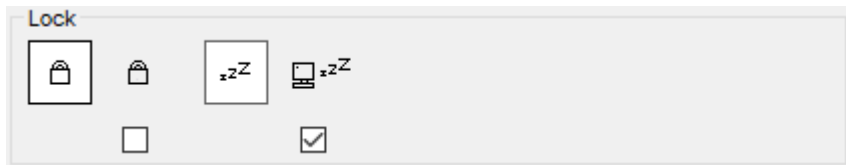

The following options are available:



- Enables a supervisor to disable user access to the functions accessed via the instrument’s soft key **B**.
- When connected to a PC the instrument will go into Sleep Mode. The instrument will “awaken” when disconnected from the PC.

**Zeroing**



The following options are available:

- When selected, the TIGER will automatically set its Zero reading based on ambient air when it is switched on. When deselected the instrument will use its calibration Zero.

-  When selected, TIGER uses the fixed calibration Zero. If used in conjunction with the 'Zero at switch on' option, the instrument will Zero at switch on and then remain at that level.
-  When selected, the Zero level will change to negative if cleaner ambient air is detected. This ensures 0.0 ppm is displayed in clean air and ensures sub ppb levels are always detected.

**Zones**

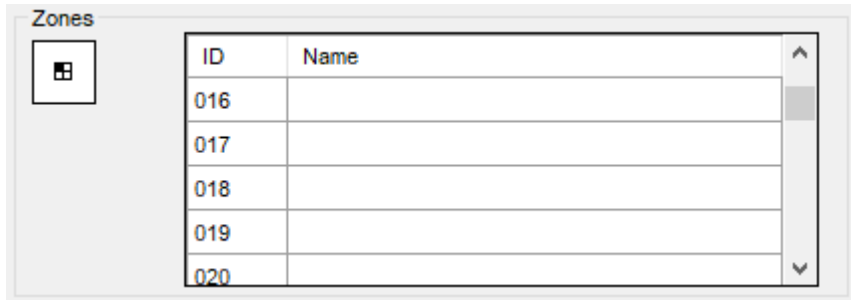



ID	Name
016	
017	
018	
019	
020	

Use this table to define and name up to 128 separate zones. The name field is limited to eight characters including spaces.

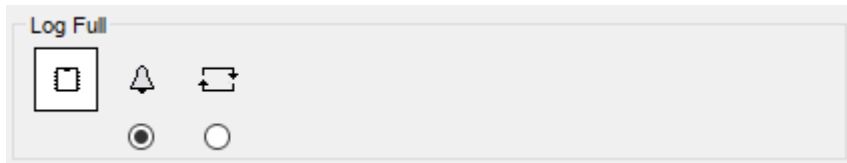
**Log Full**



Select one of the following:

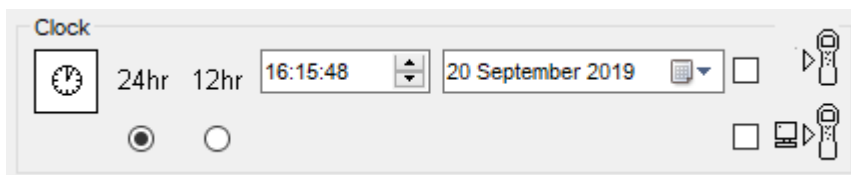

-  The instrument will alarm when the memory log is full. Logging will stop.
-  Logging will continue. New data will overwrite the oldest data in the log.

**Clock**



Select 24- or 12-hour format.

If required, select one of the following:

-  To set the time on your TIGER. Set the time and date in the fields provided.
-  To synchronize the instruments time with that of the PC.



When you have configured your instrument or completed your changes, send them to your TIGER by clicking **Send to Instrument**.

If your PC fails to write to the TIGER, seek advice from your distributor or from ION Science Inc..

Users can save a configuration setup by clicking **Save to File**. A saved configuration setup can later be used to configure the TIGER by selecting **Load from File**.

### Gas Table Screen

Select **Gas Table** from the menu to display the Gas Table screen.

The screenshot shows the 'Gas Table' interface in the TIGER software. The table lists various gases with their respective properties. The 'Select' column has checkboxes for each row. The 'Gas name' column contains names in French. The 'Abbreviation' column is mostly empty, with 'PGEEA' appearing for Acétate d'éthoxypropyl. The 'Formula' column shows chemical formulas. The 'Molecular weight' column shows numerical values. The '10.0 Lamp Factor', '10.6 Lamp Factor', and '11.7 Lamp Factor' columns show numerical values for each gas.

Select	Gas name	Abbreviation	Formula	Molecular weight	10.0 Lamp Factor	10.6 Lamp Factor	11.7 Lamp Factor
<input checked="" type="checkbox"/>	Acétamide		C2H6NO	59.067	0	2	0
<input checked="" type="checkbox"/>	Acétate de 1-phényléthyle		C10H12O2	164.2	0	0.7	0
<input checked="" type="checkbox"/>	Acétate de 2-butoxyéthyle		C8H16O3	160.2	4	2	1.3
<input checked="" type="checkbox"/>	Acétate de 2-méthoxy-1-méthyléthyle		C6H12O3	132.159	2.1	1.6	0.74
<input checked="" type="checkbox"/>	Acétate de 2-méthoxyéthyle		C5H10O3	118.13	7.8	4.89	2.27
<input checked="" type="checkbox"/>	Acétate de 3-méthoxybutyl		C7H14O3	146.18	0	2	0
<input checked="" type="checkbox"/>	Acétate de benzyle		C9H10O2	150.18	0	0.6	0
<input checked="" type="checkbox"/>	Acétate de cinnamyle		C11H12O2	176.21	0	0.4	0
<input checked="" type="checkbox"/>	Acétate de cis-3-hexényle		C8H14O2	142	1.2	1	0.55
<input checked="" type="checkbox"/>	Acétate de citronellyle		C12H22O2	198.3	0	1.5	0
<input checked="" type="checkbox"/>	Acétate de géranyle		C12H20O2	196.29	0	1.2	0
<input checked="" type="checkbox"/>	Acétate de linalyle		C12H20O2	196.286	0	1.1	0
<input checked="" type="checkbox"/>	Acétate de méthyle		C3H6O2	74.079	0	7	1.8
<input checked="" type="checkbox"/>	Acétate de n-butyle		C6H12O2	116.16	12	2.5	0.8
<input checked="" type="checkbox"/>	Acétate de n-propyle		C5H10O2	102.133	17	3	1
<input checked="" type="checkbox"/>	Acétate de p-créayle		C9H10O2	150.177	0	1	0
<input checked="" type="checkbox"/>	Acétate de pentyle		C7H14O2	130.186	9	1.8	0.64
<input checked="" type="checkbox"/>	Acétate de sec-amyle		C7H14O2	130.2	0	5	0
<input checked="" type="checkbox"/>	Acétate de sec-butyle		C6H12O2	116.16	5.5	1.8	0.8
<input checked="" type="checkbox"/>	Acétate de sec-hexyle		C8H16O2	144.213	0	1.6	2
<input checked="" type="checkbox"/>	Acétate de tert-butyle		C6H12O2	116.16	1.65	1.05	0.83
<input checked="" type="checkbox"/>	Acétate de vinyle		C4H6O2	86.09	1.77	1.5	1
<input checked="" type="checkbox"/>	Acétate d'éthoxypropyl	PGEEA	C7H14O3	146.18	0	1.2	0
<input checked="" type="checkbox"/>	Acétate d'éthyle		C4H8O2	88.106	40	4.5	1.4
<input checked="" type="checkbox"/>	Acétate d'isobornyle		C12H20O2	196.32	0	0.5	0
<input checked="" type="checkbox"/>	Acétate d'isobutyle		C6H12O2	116.16	10	2	0.8

You can modify this table and download it to your instrument.



To add new gases to the table (or delete them), click the **Menu** button and select **Allow Insert/Delete** from the drop-down menu:

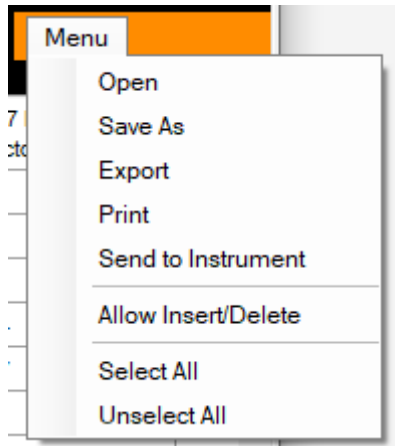

An additional row is added at the bottom of the Gas Table into which details of the new gas can be entered.

<input checked="" type="checkbox"/>	Xylène, m-		C8H10	106.167
<input checked="" type="checkbox"/>	Xylène, o-		C8H10	106.167
<input checked="" type="checkbox"/>	Xylène, p-		C8H10	106.167
<input checked="" type="checkbox"/>	Xylidines (tous)		C8H11N	121.182
<input checked="" type="checkbox"/>	New gas			
<input type="checkbox"/>				

Upper and lower alarm levels can be adjusted in the Gas Table. Type the required alarm level in the appropriate column for the gas in question.

Always save modified gas tables under a different file name. Do not overwrite the original.



For a gas to be available to the instrument, the checkbox next to its name must be ticked.

To send the Gas Table to the instrument, select **Send to Instrument** from the drop-down menu under the **Menu** button.

## Firmware Screen

This screen displays the current firmware version installed on your TIGER and provides facilities to install new versions on the instrument.

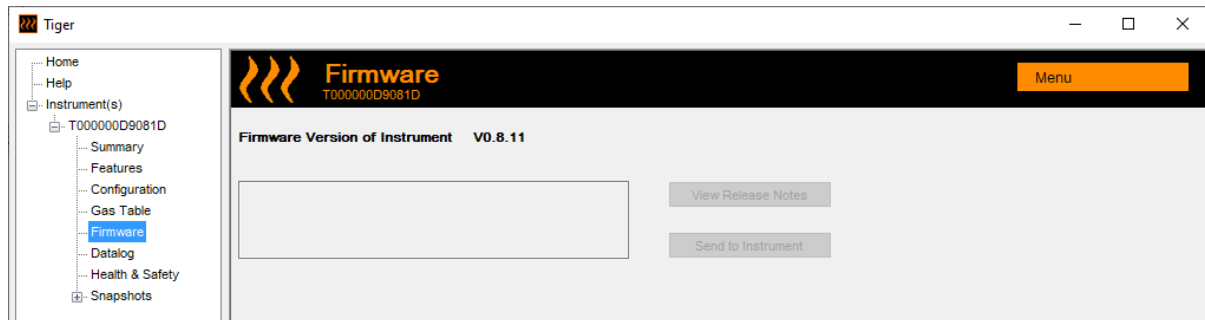

If new firmware is available, this will be noted on the screen in the box under the current firmware version: “New firmware is available”.

Click **View Release Notes** for a description of the changes in the new version.

To install a firmware update, connect TIGER to your computer as detailed previously. Ensure that your instrument is in normal operation, is not in an alarm condition and that no data-logging or Health and Safety readings are being collected. Check that the Battery Pack is sufficiently charged (at least two bars).



**Important:** The Firmware upgrade process will delete all data from the instrument. To avoid loss of any data during the process, [take a snapshot](#) of the instrument before upgrading. This can be reloaded after the update is complete.

Select **Send to Instrument** to install the upgrade on your instrument.

The following message is displayed:

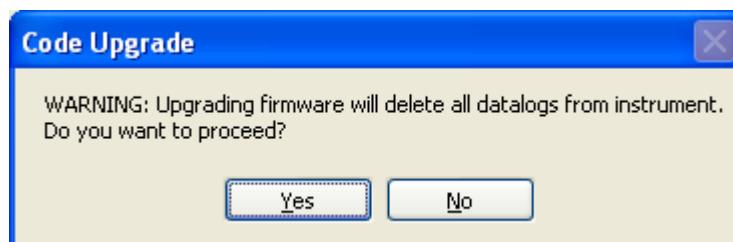

To continue, click **Yes**.

The following message is displayed:

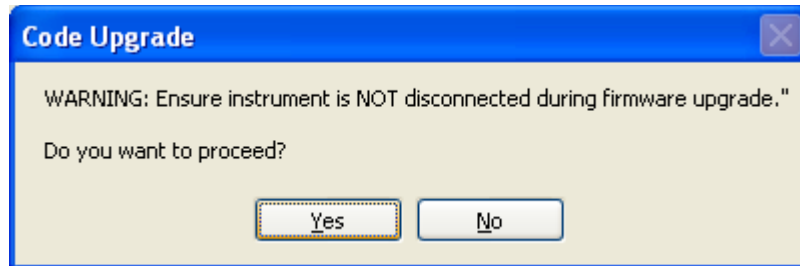

Check that the instrument is connected and click **Yes**.



**Important:** Do not operate your TIGER during the update process.

The firmware will now be sent to the TIGER. A bar at the bottom of the screen will indicate the progress of the update.

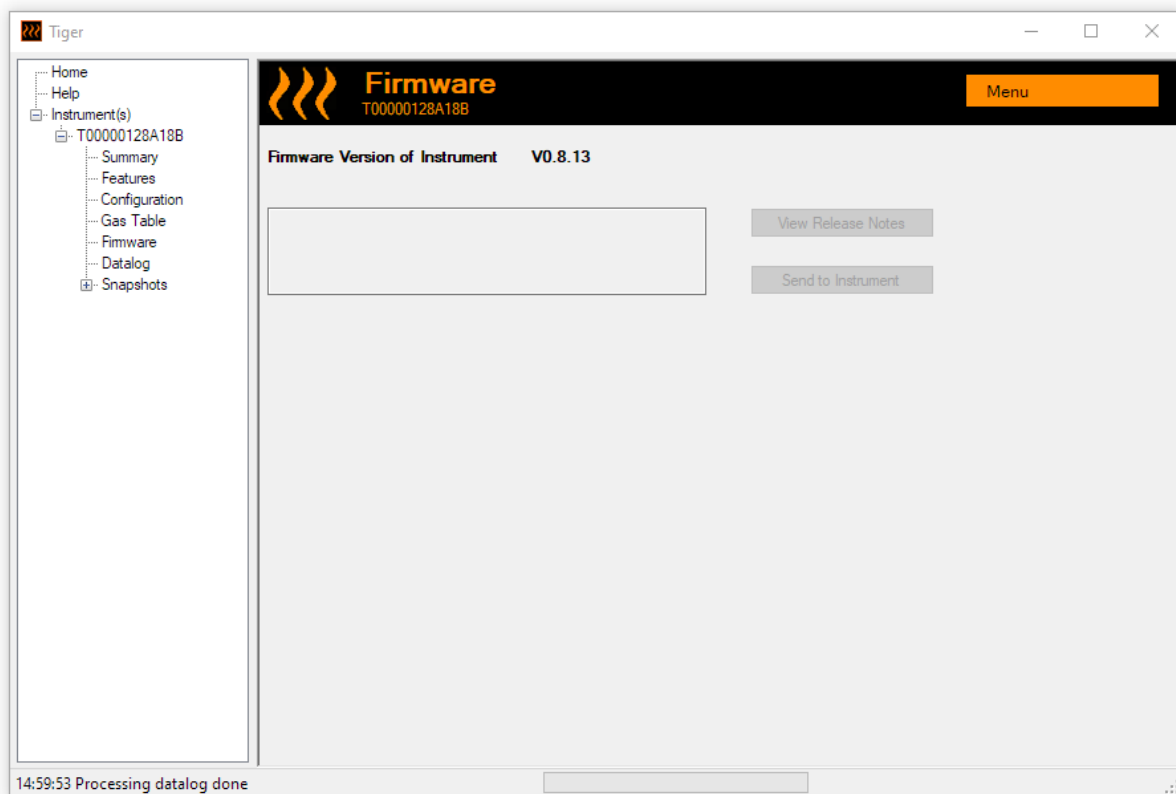

The new firmware version will be shown on the screen.



**Important:** Do not disconnect the TIGER at this point. Follow the instructions below before disconnecting.

After the upgrade been sent to the TIGER, the instrument will install it. The TIGER will flash the two torch LEDs. The screen on the TIGER will remain blank for about 30 seconds. A progress bar will then be displayed as the installation takes place:



A 'verifying file system' message will then be displayed.

The firmware is now installed on the instrument. It will then restart automatically.

### Datalog Screen

This screen is used to view data logged readings downloaded from your TIGER, if a relevant [upgrade has been installed](#). New readings are downloaded from the TIGER [when the instrument is read](#).

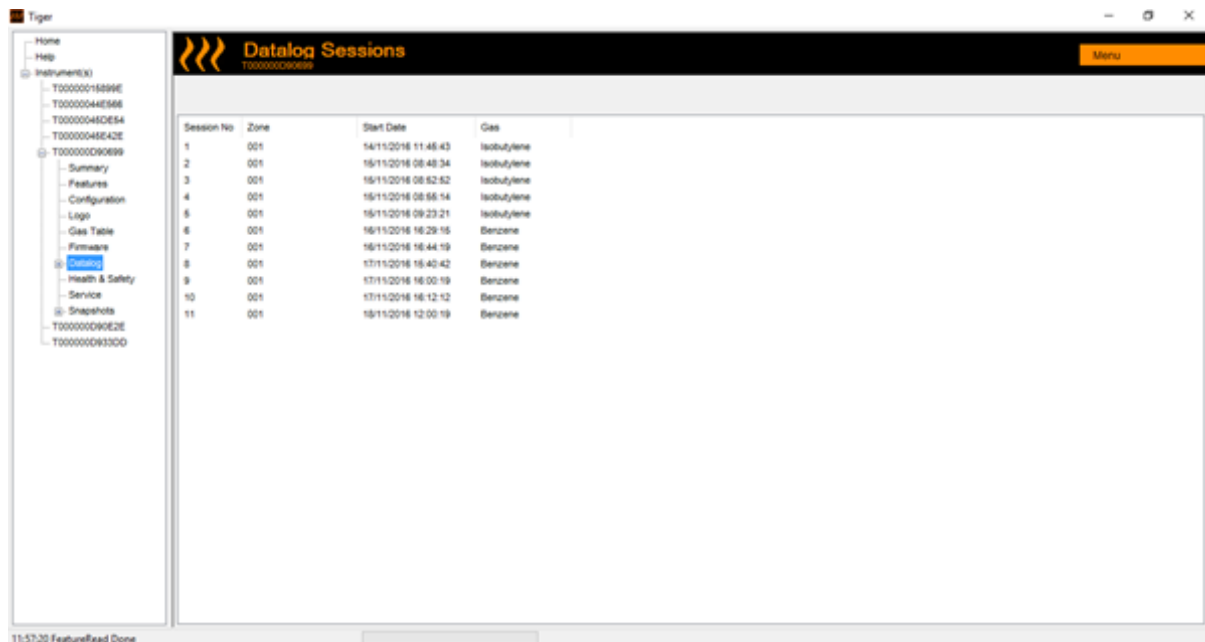

The **Datalog** sub-menu displays a list of the Datalog sessions.

Click on a session. Details of the data collected during that session are presented in numerical and graphical form on the Datalog screen.

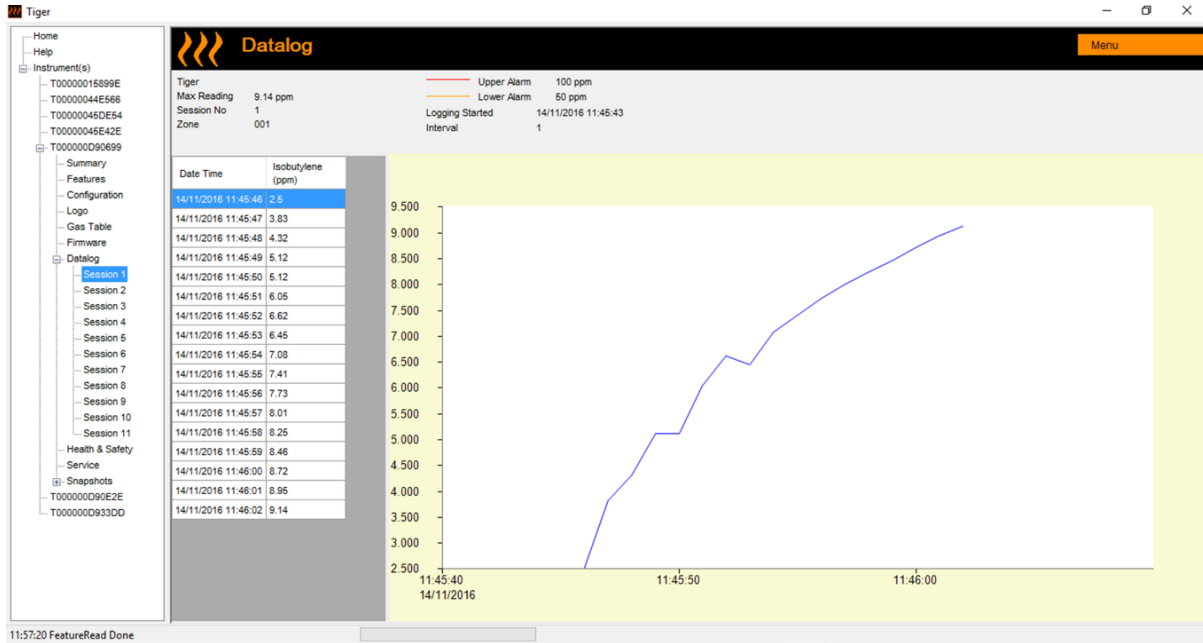

Use the menu accessed from the **Menu** button in the top right-hand corner of the window to zoom, print, or export the data.



**Important:** The **Delete** option on the menu deletes all logged data from your TIGER. Ensure all valuable data is exported to your PC before selecting it.

### Health & Safety Screen

This screen displays the latest Health and Safety readings held on your TIGER, if the relevant [upgrade has been installed](#). New readings are downloaded from the TIGER [when the instrument is read](#).

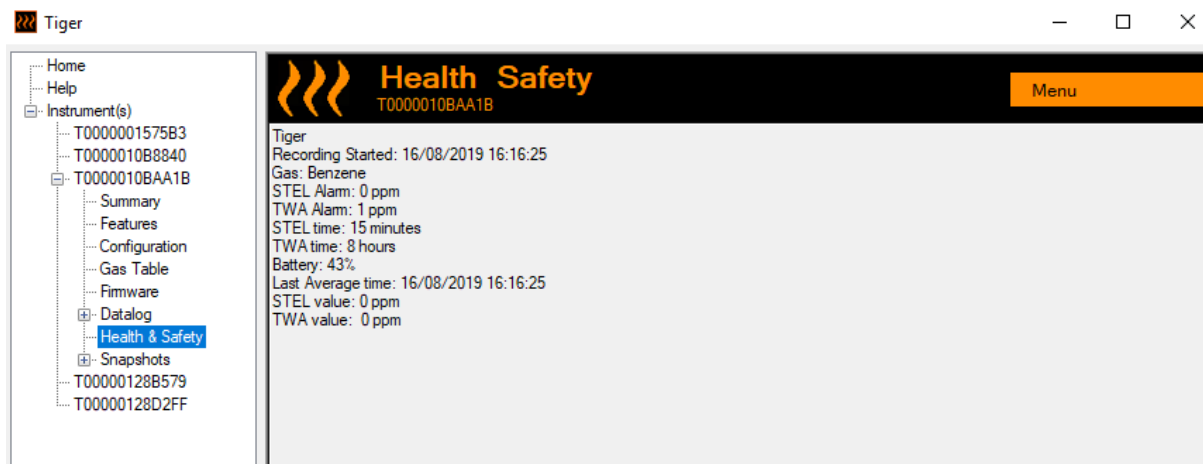

Click **Menu** then **Export** to save this data to a file on your computer. The next Health and Safety readings will overwrite the existing data on your TIGER.

### Snapshots Screen

A snapshot records the calibration settings of your TIGER at a point in time. If required, your TIGER can be reset to a snapshot's settings. The Snapshots screen lists those stored on the PC.

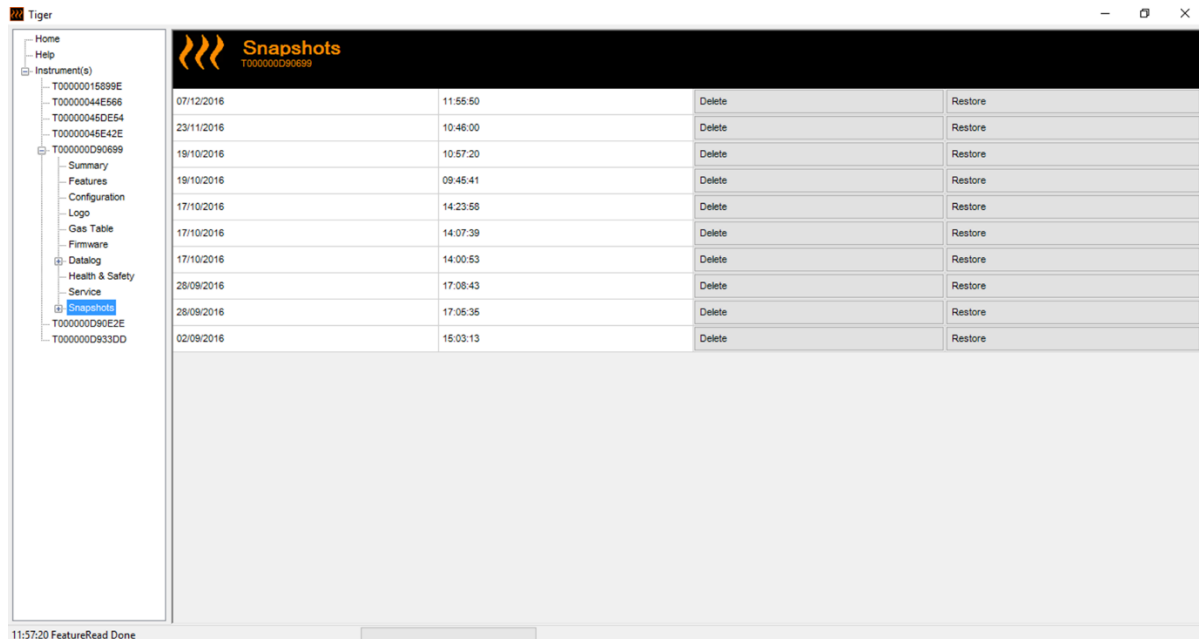

Details of a snapshot can be viewed by expanding the menu entry for that snapshot and accessing the Features, Summary, Configuration etc. screens for the snapshot:

Tiger

Feature Name	Status
Data Logging - 861303 (Full)	OK
Health & Safety - 861300 (STEL & TWA)	OK
ppb - 861301 (Sensitivity)	OK
Single log only - 861309 (Push to log)	Disabled
Multi log only - 861310	Disabled
Tiger Select	Disabled

The data on these screens cannot be edited.

To restore the stored settings to your TIGER, first ensure that your instrument is fully booted and [connected to your PC as described previously](#). Ensure that your instrument is in normal operation, is not in an alarm condition and that no data logging or Health and Safety readings are being collected.



**Important:** Be aware that this process will replace all setup and calibration files.

Click **Restore** against the relevant snapshot.

On the restore pop-up that is then displayed:

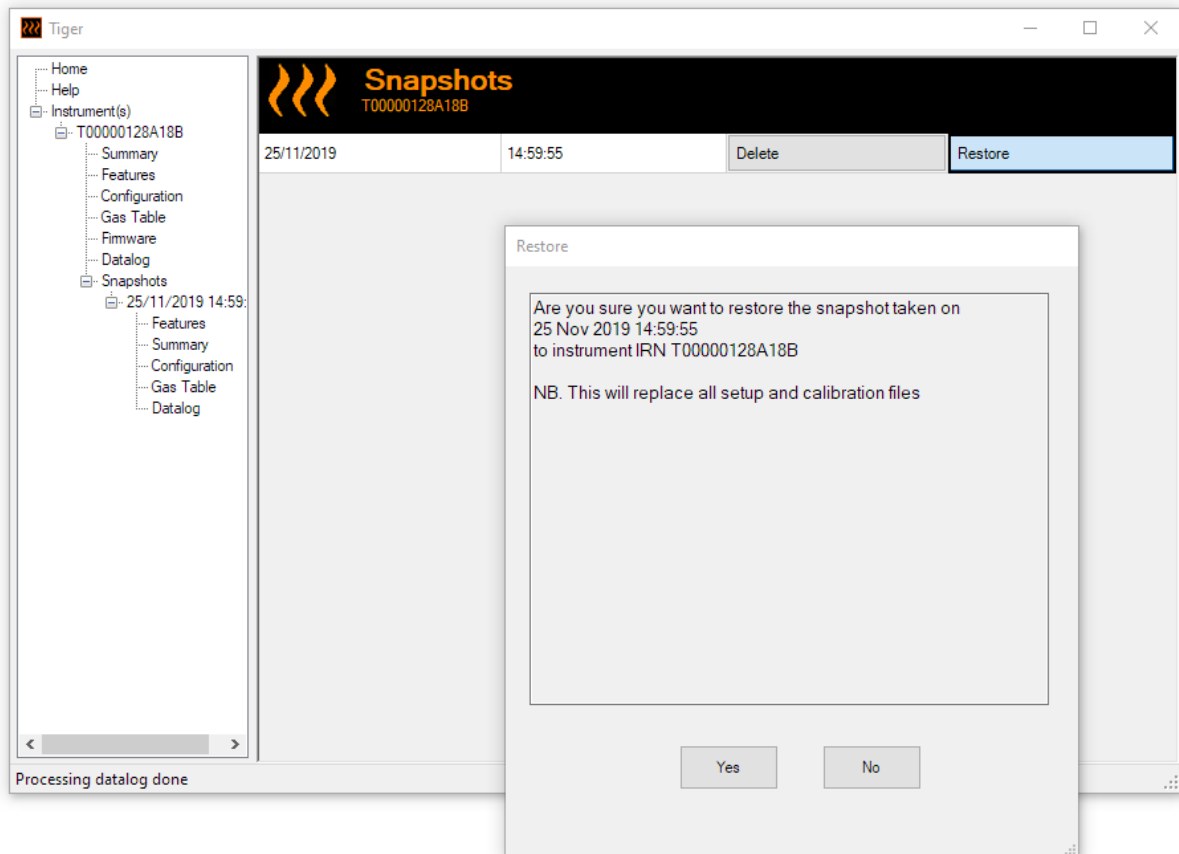

Click **Yes** to load the snapshot. When the loading is complete, click **Close** and restart your TIGER. Your TIGER will now be restored to the settings and calibration data stored at the time of that snapshot.

The snapshot menu also allows stored data to be reviewed when an instrument is not attached.



Expand the menu until the relevant snapshot is displayed. Double-click on the snapshot. All the data stored in that snapshot can now be viewed.

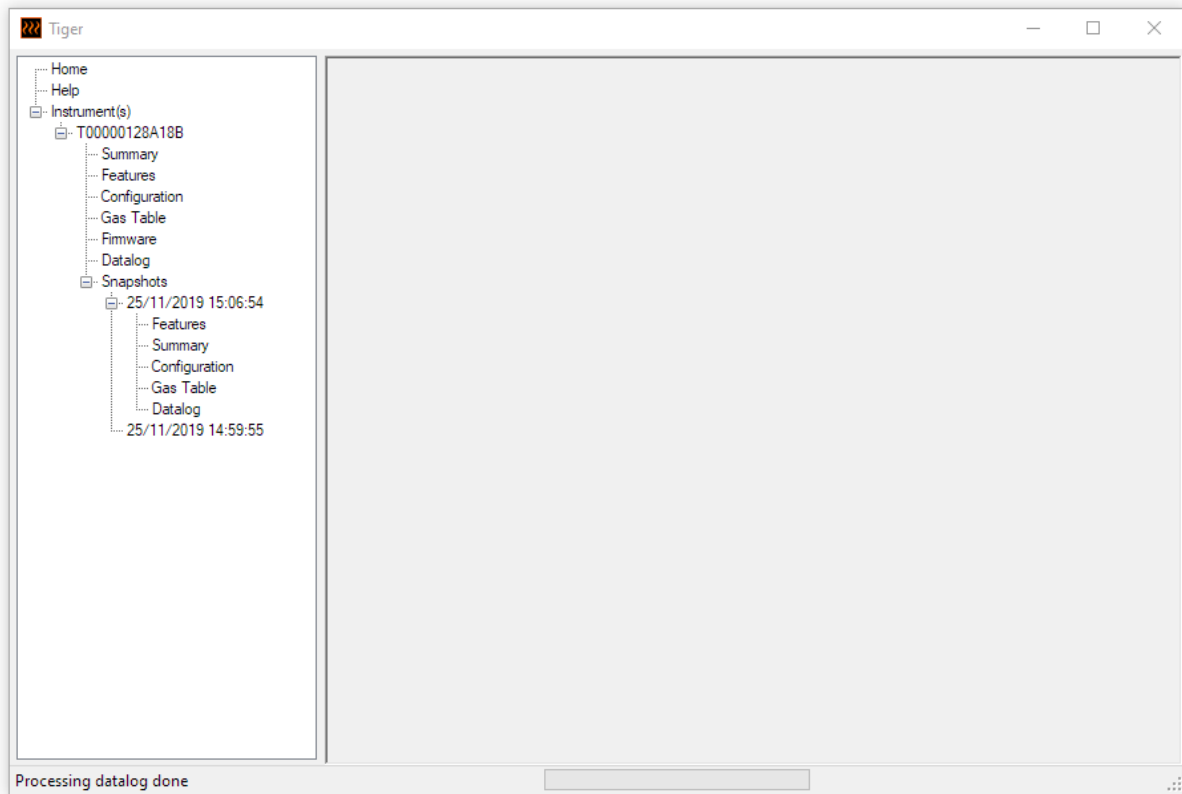

Click **Delete** to remove a selected snapshot.

## 7. Calibration



**ION Science recommends that personnel responsible for equipment use institute a regime of regular checks to ensure it performs within calibration limits, and that a record be maintained which logs calibration check data.**

### Calibration

TIGER offers the following calibration options:

- Factory Calibration** is set by ION Science Inc. during instrument manufacture or on re-calibration by an ION Science authorized service center, for example during an annual service. Factory Calibration offers a safe set of three-point calibration data. This should be used if the current custom calibration fails and will keep the unit working until a good custom calibration is completed. Please contact ION Science Inc. or your local distributor for further information.

ION Science Inc. recommends annual servicing and calibrations for users who require traceable calibration records. During this service, the Lamp and MiniPID 2 Sensor are brought back to factory specifications and new Factory Calibration data is loaded.

- Custom Calibration** is performed by the instrument user and should be carried out as part of regular instrument maintenance. Before doing so, first set up the [calibration parameters in TigerPC](#).

TIGER scales its linear output across a Zero level (clean air reference) and the SPAN 1 user-defined gas concentration. Due to the linear output of the ION Science MiniPID 2 Sensor, a two-point calibration is often adequate. However, for more exacting requirements, TIGER therefore offers a three-point calibration which uses an additional SPAN 2 higher gas concentration.

### Custom Calibration

Before proceeding, ensure the [calibration parameters are set in TigerPC](#):

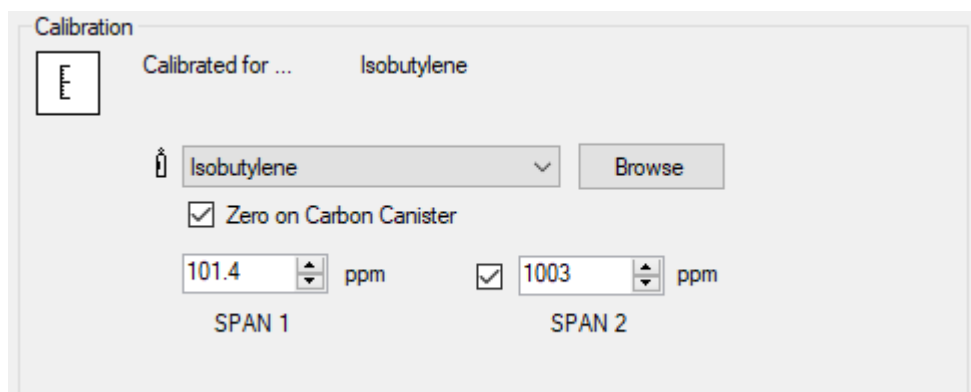

TIGER allows you to custom calibrate using any gas from the Gas Table at any concentration from 10 ppm. You will need a cylinder of the gas at the chosen concentrations.

Have the cylinder(s) of gas, regulator(s) and the Carbon Filter Assembly ready before starting the procedure. Alternatively, a known clean air supply may be used as the Zero gas. Demand flow regulators are recommended for the calibration of the TIGER. If flow regulators are to be used then a 0.3l/min is recommended, a flow adaptor should be used to avoid over-pressurising the instrument (sold separately). Please ensure you are familiar with the entire calibration procedure before attempting to calibrate your TIGER.





The calibration of your TIGER must be carried out in a clean air environment. Ensure all parts of the Calibration Kit are available and ready for use.



Never calibrate the Zero with the span gas connected.

### Custom Calibration Procedure

1. From the main running screen, select the 'CAL' icon. 
2. Highlight the PID option and press 'OK'.
3. Select the 'Custom Calibration' icon. 
4. **Zero calibration:** Attach the Carbon Filter Assembly (if using) and select 'OK' to commence Zero calibration sequence. The display will countdown 30 seconds. Once complete, select 'OK' to proceed. Disconnect the Carbon Filter Assembly and replace the cap ends.



The useful life of the Carbon Filter Assembly will be shortened if it is open to atmosphere for prolonged periods.

5. **SPAN 1 calibration** SPAN 1: The gas and concentration for SPAN 1 (previously set up in TigerPC) are displayed along with a 30 second countdown. Attach the SPAN 1 gas and press **Enter** to start the SPAN 1 countdown.

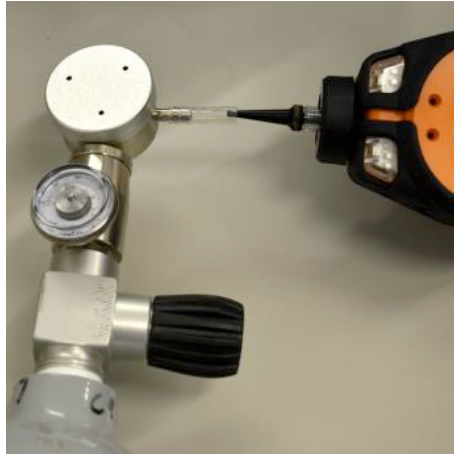

6. At the end of the countdown a tick '✓' will appear, indicating that the SPAN 1 has been accepted. Press **Enter**. For a two-point calibration, the calibration procedure is complete.
7. **SPAN 2 calibration** SPAN 2: For a three-point calibration, the gas and concentration for SPAN 2 are displayed (previously set up in TigerPC) along with a 30 second countdown. Attach the SPAN 2 gas and press **Enter** to start the SPAN 2 countdown.

To skip SPAN 2, press **Esc** and then 'skip' to complete a SPAN 1 only calibration and return to the main running screen.

8. At the end of the count down a tick '✓' will appear, indicating that the SPAN 2 has been accepted. Press **Enter** again to complete the calibration procedure.

## 8. Maintenance



Inadequate performance of the gas detection equipment described in this manual may not necessarily be self-evident and consequently equipment must be regularly inspected and maintained.



Do not use abrasive or chemical detergents to clean the instrument as this may reduce the antistatic properties of the materials used, clean it using a damp cloth only.

### TIGER Parts Diagram



- |                             |                        |                      |
|-----------------------------|------------------------|----------------------|
| 1 Instrument Body           | 7. Sensor Gasket       | 12. Filter Clamp     |
| 2 Rechargeable Battery Pack | 8. Instrument Boot     | 13. PTFE Filter Disc |
| 3 AA Battery Pack           | 9. Sensor Seal         | 14. Probe - Tiger    |
| 4 Charge Cradle             | 10. Inlet/Outlet Seal  | 15. O-ring           |
| 5 Sensor Cover              | 11. Filter Housing Cap | 16. Probe Seal       |
| 6 MiniPID 2 Sensor          |                        |                      |

## Batteries

### Battery Packs

Two Battery Packs are available for the TIGER, a rechargeable Lithium-ion Battery Pack and a non-rechargeable AA Alkaline Battery Pack for 3 AA Alkaline batteries.

- The rechargeable Lithium-ion Battery Pack is recommended for normal operation. The TIGER is supplied with it as standard.
- The non-rechargeable AA Alkaline Battery Pack should only be used when no power is available to recharge the rechargeable pack.

The Rechargeable Battery Pack is normally fitted as standard to the instrument when shipped.

### Recharging Batteries



**BATTERY CHARGING: CHARGE THE TIGER AND ITS LITHIUM ION BATTERY PACKS IN A NON-HAZARDOUS ENVIRONMENT ONLY.**



**Battery Connection: Ensure all electrical connections are clean and undamaged before connection. The TIGER instrument's ingress protection rating is reduced to IP20 when its Battery Pack is removed so avoid changing batteries in dusty or wet environments.**



**Lithium Ion Batteries can be damaged if left in a discharged state. Please recharge if battery indicator is showing empty. Please note also that if the instrument is left for one year unused, it needs to be charged fully before it can continue to be kept in storage. Please repeat annually.**

Ensure the TIGER is charged for at least 7 hours before using it for the first time. To ensure optimum charging, the TIGER should be switched off. If left on, the TIGER will take longer to charge, but will not suffer any damage. The TIGER should only be charged in non-hazardous environments.

To charge your TIGER, connect the Charge Cradle to the mains. A red light on the charger indicates that it is ready. Place the TIGER in the Charge Cradle so that the contacts on the TIGER are aligned with those in the cradle. There is no need to remove the Instrument Boot from the TIGER.



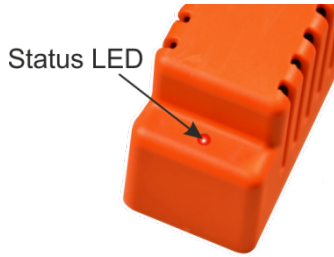

LED Color	Meaning
RED	Power connected, not charging.
AMBER	Instrument charging.
GREEN	Instrument fully charged.

The battery icon on the TIGER will display the level of charge:

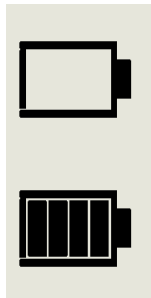

**Battery empty**  
When the battery is nearly empty, the icon will flash for one minute before the instrument shuts down.

**Battery fully charged**



Only use the Charge Cradle supplied with your TIGER.



ION Science Inc. recommends keeping your TIGER on charge at all times when not in use, as batteries can lose power over time.

### Replacement of Rechargeable Battery Packs



**Battery Use: Use supplied battery packs only on the TIGER.**

To replace the Rechargeable Battery Pack:

1. Ensure TIGER is switched Off.

2. Remove the Instrument Boot:



3. Release the clip at the rear of the instrument and lift the Rechargeable Battery Pack away from the Instrument Body while sliding it slightly backwards:

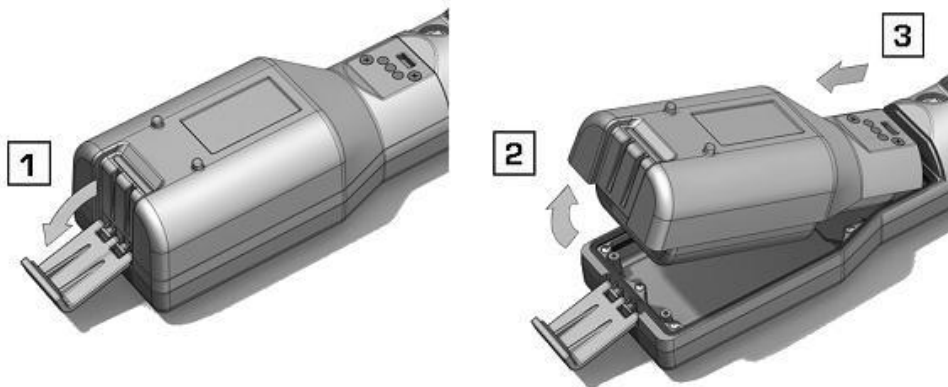

4. Reverse the previous step to slide the replacement battery pack into the Instrument Body and secure it using the clip.
5. Replace the Instrument Boot ensuring that it is snug around the front of the Instrument Body and the lights are not obscured.
6. Charge the TIGER for 7 hours before use.

### Replacement of Non-rechargeable Batteries



**BATTERY REPLACEMENT: NEVER REPLACE PRIMARY ALKALINE BATTERY CELLS WHILE IN A POTENTIALLY EXPLOSIVE OR HAZARDOUS LOCATION. USE ONLY INDUSTRIAL BY DURACELL ID1500 BATTERIES.**



**Fitting batteries or connecting the Battery Pack with the wrong polarity may result in damage to the instrument.**



1. Ensure TIGER is switched Off.
2. Remove the Instrument Boot (see [Replacement of Rechargeable Battery Packs](#)).
3. Remove the AA Battery Pack.
4. Remove the screws retaining the battery cover and lift it off. This reveals the batteries in the Battery Holder.
5. Remove the Battery Holder.
6. Replace the batteries. Use Industrial by Duracell ID1500 batteries.
7. Check that the polarity of the batteries is correct. Replace the Battery Holder.
8. Refit the battery cover and the securing screws.
9. Replace the Instrument Boot ensuring that it is snug around the front of the Instrument Body and the lights are not obscured.

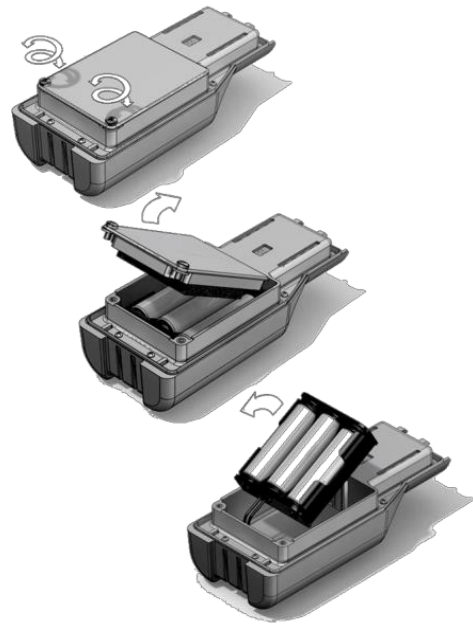

**WEEE REGULATIONS**

Dispose of used batteries in accordance with all local and national safety and environmental requirements.

**Inlet Probe Assembly**

All parts of the probe assembly can be replaced if they become damaged or contaminated with use.

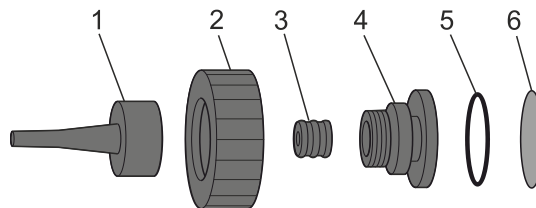

- |                      |                    |
|----------------------|--------------------|
| 1 Inlet Probe        | 4 Filter Clamp     |
| 2 Filter Housing Cap | 5 O-ring           |
| 3 Probe Seal         | 6 PTFE Filter Disc |

## PTFE Filter Disc



It is essential that the TIGER is always used with a supplied 0.5-micron PTFE Filter Disc fitted to the front of the instrument. Without the filter, particles of debris and dust can be drawn into the MiniPID 2 Sensor inhibiting the function of the instrument. These filters are consumable and should be changed after every 100 hours of use. The frequency of replacement should be increased for dusty or moisture laden environments. PTFE Filter Discs are available from your distributor or at [www.ionscience-usa.com](http://www.ionscience-usa.com).

PTFE Filter Disc changing should be conducted in a suitably clean environment, with clean hands and equipment to avoid contamination of the new PTFE Filter Disc.

To change the PTFE Filter Disc (see the [Inlet Probe Assembly](#)):

1. Unscrew the Filter Housing Cap and lift off the Filter Clamp and O-ring.
2. Lift the PTFE Filter Disc from the Instrument Body. Carefully place a new PTFE Filter Disc into the Instrument Body.

*Under no circumstances should a PTFE Filter Disc be used once it has been removed.*

3. Replace the Filter Clamp, ensuring that the O-ring is correctly seated.
4. Replace the Filter Housing Cap. Do not over-tighten.

## Probe Seal

The Probe Seal (see the [Inlet Probe Assembly](#)) should be inspected and replaced when required.

## Water Ingress

If the instrument has been immersed or splashed with water, take the PID 2 Sensor out to dry (see below) and replace the PTFE Filter Disc as described previously.

## Lamp Cleaning and Electrode Stack Replacement



**The TIGER is a sensitive detector. Internal components must be handled with clean hands and clean tools. The Lamp is fragile. Handle with great care. Never touch the window and do not drop.**

### When to Clean or Replace the Lamp

The TIGER MiniPID uses an ultraviolet light source ionizing VOC gases as they pass across the Lamp window. This process may result in a fine layer of contamination on the detector window that must be removed on a regular basis.

- In normal use the Lamp should be cleaned after every 100 hours (based on 30 ppm for 100 hours). If the Tiger is used in heavily gas contaminated environments, the Lamp should be cleaned more often.
- Please note that some esters, amines and halogenated compounds may accelerate window fouling; in these cases cleaning may be required after every 20 hours of use.

- Cleaning frequency will also depend upon alarm levels set and prevailing environmental conditions.
- Damaged Lamps must be replaced immediately. Do not use a Tiger with a damaged Lamp.

### When to Replace the Electrode Stack

When using your Tiger in conditions of high ambient humidity, it may show unexpected and increasing readings. This is due to dust or other small particles within the detector becoming hydrated which causes these particles to conduct a signal between the electrodes.

The problem can be resolved by replacing the Electrode Stack.

### Removing the MiniPID 2 Sensor



**Protect the MiniPID 2 Sensor from exposure to silicone vapors as this may foul the windows of the Lamps and reduce response to some gases. This can usually be remedied by polishing the Lamp window with alumina powder.**



**Do not remove the MiniPID 2 Sensor Cover in the hazardous area.**

Before Lamp cleaning or replacement, the the MiniPID 2 Sensor must be removed.

First ensure that the TIGER is turned off and that you are in a clean environment so that the sensor parts will not be contaminated by dust, oil or grease.



On the Sensor Cover loosen the center screw turning it with a small coin or a suitable flat bladed screwdriver and remove the Sensor Cover.

Ensure that the Sensor Seal, on the inside of the Sensor Cover is not disturbed.

Carefully lift the MiniPID 2 Sensor from the Instrument Body, ensuring that the two Inlet/Outlet Seals remain in place in the Instrument Body.



Using the Mini PID Electrode Stack Removal Tool provided, locate its 'prongs' in the slots in the side of the Mini PID 2 Sensor body:

Using the forefinger to restrain the white Electrode Stack (the internal parts of the MiniPID 2 Sensor are spring-loaded), squeeze the Removal Tool to release the Electrode Stack.

At this point the [MiniPID Electrode Stack can be replaced](#).

### Lamp Removal and Examination



**The TIGER is a sensitive detector. Internal components must be handled with clean hands and clean tools. The TIGER Lamp is fragile. Handle with great care. Never touch the window and do not drop.**

Following removal of the Electrode Stack as described previously, the Lamp may now be removed.

Carefully remove the Lamp:

- If the Lamp is held in the Electrode Stack, carefully pull it out of the O-ring around the well in the underside of the Electrode Stack.
- If the Lamp is sitting in the sensor body - the Lamp can be gripped and lifted out or the sensor body can be inverted and the Lamp tipped out.

Inspection of the Lamp may reveal a layer of contamination on the detection window. This appears as a 'blue hue.' To check for this, hold the Lamp in front of a light source and look across the window surface at an angle.

If necessary, clean the Lamp.

### Lamp Cleaning

Clean the window using the PID Lamp Cleaning Kit supplied.



**THE LAMP CLEANING COMPOUND CONTAINS ALUMINIUM OXIDE AS A VERY FINE POWER. THIS MAY CAUSE IRRITATION OF RESPIRATORY TRACT AND EYES. (CAS Number 1344-28-1).**

A full material safety data sheet MSDS is available on request from ION Science Inc. The key issues are listed below.

**Handling:**

- Do not breathe vapor/dust. Avoid contact with skin, eyes and clothing.
- Wear suitable protective clothing.
- Follow industrial hygiene practices: Wash face and hands thoroughly with soap and water after use and before eating, drinking, smoking or applying cosmetics.
- The Compound has a TVL (TWA) of 10 mg/m<sup>3</sup>.

**Storage:**

- Always replace the lid after using the cleaning compound.
- Keep container closed to prevent water adsorption and contamination.

The cleaning procedure is as follows:

1. Open the vial of Aluminium Oxide polishing compound. With a clean cotton bud collect a small amount of compound.
2. Use this cotton bud to polish the Lamp detection window. Use a circular action applying light pressure to clean the detection window. Never touch the detection window with fingers.



3. Continue polishing until an audible “squeaking” is made by the cotton bud with compound moving over the window surface (usually within fifteen seconds).
4. Remove the residual powder with a short blast of air from the can of clean, dry, oil free air.
5. Refit the Lamp into the Electrode Stack as described previously.

**Replacing a Lamp**



**Never refit a damaged Lamp.**



**The instrument MUST be re-calibrated after fitting a replacement or cleaned Lamp.**

Following removal of the Electrode Stack as described previously, the Lamp may be replaced.

Carefully remove the Lamp:

- If the Lamp is held in the Electrode Stack, carefully pull it out of the O-ring around the well in the underside of the Electrode Stack.
- If the Lamp is sitting in the sensor body - the Lamp can be gripped and lifted out or the sensor body can be inverted and the Lamp tipped out.

Discard the removed (old) Lamp.

At this point the [MiniPID Electrode Stack can be replaced](#).

### Replacing the MiniPID Electrode Stack

At this point the MiniPID Electrode Stack can be replaced.

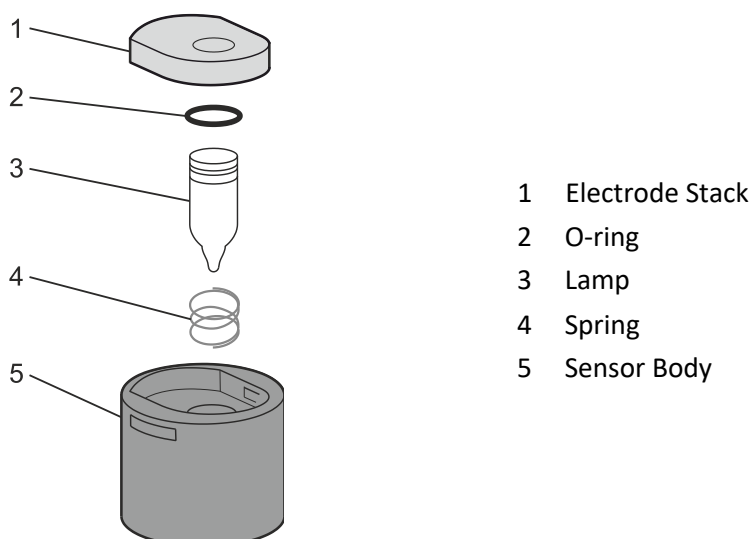

Discard the removed (old) Electrode Stack, carefully removing the Lamp if still attached.

Visually check the condition of the Lamp detection window (the upper flat surface of the Lamp). If this needs cleaning, proceed as detailed later.

Place the Electrode Stack onto a clean, flat surface, flat surface downwards. Carefully twist the detection window end of the Lamp into the O-ring around the well in the underside of the Electrode Stack. The Lamp window should now sit flush within the Electrode Stack.



This procedure ensures that the Lamp is firmly held in the Electrode Stack with the detection window level with the electrodes for consistent and reliable VOC readings. Lamp placement by any other means is likely to give unreliable readings because the O-ring in the Electrode Stack becomes trapped between the window face and the Electrode Stack.

Carefully align the MiniPID 2 Sensor body over the Electrode Stack plus Lamp. Push the sensor body down to secure the assembly - two clicks should be heard.

Carefully align/push the new MiniPID 2 Sensor into the Instrument Body.

Then ensuring, the PTFE Filter Disc and O-ring are correctly positioned, screw the Sensor Cover back onto the Instrument Body. Do not over-tighten.

The instrument **MUST** now be re-calibrated.

## 9. Troubleshooting

### Diagnosics

Basic faults or diagnostics are presented as symbols. Most faults can be corrected by pressing **Enter** or **Esc** to clear the fault message. All fault conditions cause the TIGER to alarm.

#### Pump failure



#### *Pump blocked or pump failure*

The flow of gas through the instrument has fallen below 50cc/minute. Check the Probe and PTFE Filter Disc for signs of blockage. Water or dirt in the Probe, a bent Probe, dirty PTFE Filter Disc on the inlet or blockage of the exhaust can all cause low flow. If the blockage can be removed, press **Esc** to clear the alarm. If the fault persists send the instrument to your distributor for service.

#### Battery dead

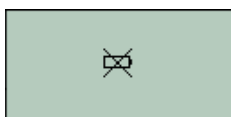

#### *Battery low or battery failure*

The TIGER will shut down when the battery level falls below 2%. Recharge the battery as instructed in the [Batteries](#) section of this manual ensuring that all connections are sound and the indicator lights on the charger are in order. If the battery fails to charge, fit another battery pack if available. If using alkaline batteries, replace them. If the fault persists send the instrument and charger to your distributor for service.

#### Lamp out



#### *Lamp failure*

The PID Lamp has failed to strike (illuminate); this may occur at switch on or during use. Try switching the TIGER off and on. If this fault persists then the electrode stack or lamp should be replaced. (See the [PID Sensor/Lamp Replacement and Cleaning](#) section).

#### Memory full



#### *Memory cannot receive more data*

The data log memory is full. This will only happen if the Log Full box is set to 'alarm' on the TigerPC configuration screen. Press the **Esc** key to continue, but the TIGER will no longer continue to log data. Select 'recycle' in TigerPC and the TIGER will overwrite the oldest data and no alarm will be raised.

#### System error



#### *Total system failure*

The instrument's firmware is corrupted. In the unlikely event of this message appearing, contact ION Science Inc. or your nearest authorized service center.



## 10. Appendix and Supporting Documents

### EU Declaration of Conformity

The EU Authorised Representative of the manufacturer Ion Science limited has sole responsibility, on the date this product accompanied by this declaration is placed on the market, the product conforms to all technical and regulatory requirements of the listed directives

**Authorised Representative:** ISM Deutschland GmbH · Laubach 30 · D-40822 Mettmann, Germany

**Product:** PhoCheck TIGER

**Product description:** Intrinsically safe photo-ionisation gas detector for detecting volatile organic compounds

**Directive:** ATEX Directive (2014/34/EU)  
EMC Directive (2014/30/EU)

**Type of protection:**  II 1 G Ex ia IIC T4 Ga  
T<sub>amb.</sub> = -15°C to +45 °C (with Lithium ion Battery Pack)  
T<sub>amb.</sub> = -15 °C to +40 °C (with Alkaline Battery Pack)

**Certificate Number:** ITS09ATEX26890X

**Notified body:** Intertek, 2575, Miglioli, Italy

**North American certifying authority:** **Intertek:**

**North American File#:** 102394781CHE-001

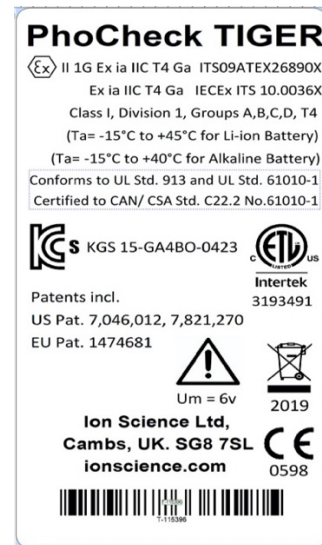

**Standards:**

- EN IEC 60079-0: 2012** Electrical apparatus for explosive gas atmospheres. General requirements
- EN IEC 60079-11: 2012** Explosive atmospheres. Equipment protection by intrinsic safety "i"
- EN 61326-1:2006** Electrical equipment for measurement, control and laboratory use - EMC requirements. Group 1, Class B equipment - (emissions section only)
- EN 61326-1:2006** Electrical equipment for measurement, control and laboratory use - EMC requirements. Industrial location immunity - (immunity section only)
- EN 50270:2006** Electromagnetic compatibility - Electrical apparatus for the detection and measurement of combustible gases, toxic gases or oxygen. Immunity Type 2 - industrial environments.

**Other Standards:**

- EN ISO/IEC 9001:2015** Quality Management System – Requirements
- EN ISO/IEC 80079-34 :2020** Potentially Explosive Atmospheres – Application of Quality Systems

**Name:** Clemens A. Verley

**Position:** Chief Executive Officer



**Signature:**

**Date:** 31<sup>st</sup> December 2020

## Technical Specifications

<b>Minimum Resolution</b>	10.6 eV: 0.001 ppm (1 ppb) *** 11.7 eV: 0.6 ppm (600 ppb) ***
<b>Detectable Range</b>	10.6 eV: 1 ppb up to 20,000 ppm *** 11.7 eV: 9,000 ppm ***#
<b>Response Time</b>	10.6 eV: T90 < 2 seconds 11.7 eV: < 6 seconds
<b>Accuracy</b>	10.6 eV: +/- 5% display reading +/- one-digit *** 11.7 eV: +/- 12% display reading ***
<b>Intrinsically Safe Approvals</b>	<ul style="list-style-type: none"> <li>•  II 1G Ex ia IIC T4 Ga</li> <li>• Tamb = - 15 oC ≤ Ta ≤ +45 oC (with Lithium ion Battery Pack)</li> <li>• Tamb = - 15 oC ≤ Ta ≤ +45 oC (with Alkaline Battery Pack)</li> <li>• ITS09ATEX26890X IECEx ITS 10.0036X</li> <li>• 3193491 conforms to UL Std. 913, 61010-1 &amp;</li> <li>• Certified to CAN/CSA Std. C22.2 No. 61010-1</li> </ul>
<b>Battery Life</b>	<p><b>Li-ion:</b></p> <ul style="list-style-type: none"> <li>• up to 24 hours</li> <li>• charge time 6.5 hours</li> </ul> <p><b>Alkaline 3 x AA:</b></p> <ul style="list-style-type: none"> <li>• typically 8.5 hours life</li> </ul>
<b>Lamps</b>	<ul style="list-style-type: none"> <li>• 10.0 eV Krypton</li> <li>• 10.6 eV Krypton (standard)</li> <li>• 11.7 eV argon</li> </ul>
<b>Data Logging</b>	> 120,000 data log points including date and time stamp
<b>Communication</b>	Direct USB 1.1
<b>Calibration</b>	2-point and 3-point calibration (via calibration kit accessory)
<b>Alarms</b>	<ul style="list-style-type: none"> <li>• Flashing LED's amber (low alarm) red (high alarm)</li> <li>• Sounder 95 dBA at 300 mm (12")</li> <li>• Vibration on alarm</li> <li>• Pre-programmed TWA and STEL</li> </ul>
<b>Flow Rate</b>	≥ 220 ml/min
<b>Temperature</b>	<p><b>Operating:</b></p> <ul style="list-style-type: none"> <li>• 10.6 eV: -20 to 60°C / -4 to 140°F (non-Intrinsically Safe)</li> </ul>

- environment)  
11.7 eV: 0 to 60°C
- Certified to:**
- 10.6 eV: 15 to +45°C / +5 to +113°F (Intrinsically Safe environment)
  - 11.7 eV: 15 to +45°C / +5 to +113°F (Intrinsically Safe environment)
- Storage:**
- -25 to 60°C / -5 to 140°F
- Humidity:**
- 0-99% RH (non-condensing)

- Protection**
- Designed to IP65 (heavy rain)
  - EMC tested to EN61326-1:2006, EN50270:2006 & CFR 47:2008 Class A

**Weight and Dimensions (probe fitted, no tube attached)**

**Instrument weight:** 0.75 kg

**Size:** 465 mm (18.3") H x 89 mm (3.5") W x 61 mm (2.4") D

\*Model and gas dependent.

\*\*Maximum reading is achieved with certain analytes such as ethanol.

\*\*\*Specifications are based on isobutylene calibrations at 20 °C and 1000mBar. All specifications quoted are at calibration point and under the same ambient conditions.

\*\*\*\*\* Based on continuous running.

#For indicative measurement only. Quoted accuracy achievable up to 2,000 ppm. For more accurate detection, calibration around concentration of interest is recommended.

## Warranty

Standard Warranty can be extended to up to 5 years on the PhoCheck TIGER when registering your instrument via our website: [www.ionscience.com/usa](http://www.ionscience.com/usa)

To receive your Extended Warranty, you need to register within one month of purchase (Terms and Conditions apply). You will then receive a confirmation email that your Extended Warranty Period has been activated and processed.

Full details, along with a copy of our Warranty Statement can be found by visiting:

[www.ionscience.com/usa](http://www.ionscience.com/usa)

## ION Science Contact Details

### UK and Head Office

ION Science Ltd  
The Hive, Butts Lane  
Fowlmere  
Cambridge  
SG8 7SL  
UK  
Tel: +44 (0)1763 208503  
Fax: +44 (0) 1763 208814  
Web: [www.ionscience.com](http://www.ionscience.com)  
Email: [info@ionscience.com](mailto:info@ionscience.com)

### USA Office

ION Science Inc  
4153 Bluebonnet Drive  
Stafford  
TX 77477  
USA  
Tel: +1 877 864 7710  
Web: [www.ionscience.com/usa](http://www.ionscience.com/usa)  
Email: [info@ionscienceusa.com](mailto:info@ionscienceusa.com)

### German Office

ISM ION Science Messtechnik  
Laubach 30  
Metmann-Neandertal  
D-40822  
GERMANY  
Tel: +49 2104 14480  
Fax: +49 2104 144825  
Web: [www.ism-d.de](http://www.ism-d.de)  
Email: [info@iom-d.de](mailto:info@iom-d.de)

### Italian Office

ION Science Italia  
Via Emilia 51/c  
40011 Anzola Emilia  
Bologna  
ITALY  
Tel: +39 051 0561850  
Fax: +39 051 0561851  
Web: [www.ionscience.com/it](http://www.ionscience.com/it)  
Email: [info@ionscience.it](mailto:info@ionscience.it)

### French Office

ION Science France  
41 Rue de Etoiles,  
83240 Cavalaire-sur-Mer,  
FRANCE  
Tel: +33 6 13 50 55 35  
Web: [www.ionscience.com/fr](http://www.ionscience.com/fr)  
Email: [info@ionscience.fr](mailto:info@ionscience.fr)

### Chinese Office

ION Science China Ltd  
1101 Bldg B, Far East International Plaza  
No. 317,  
Xianxia Road, Shanghai  
P.R. CHINA  
Tel: +86 21 52545988  
Fax: +86 21 52545986  
Web: [www.ionscience.com/cn](http://www.ionscience.com/cn)  
Email: [info@ionscience.cn](mailto:info@ionscience.cn)

### Indian Office

ION Science India Pvt. Ltd  
Image Hospital Lane,  
Madhapur,  
Hyderabad – 500 081,  
Telangana State,  
INDIA  
Web: [www.ionscience.com/in](http://www.ionscience.com/in)  
Email: [kschar@ionscience.com](mailto:kschar@ionscience.com)

Manual Log

Manual version	Amendment	Issue Date	Instrument Firmware	PC Software
	For previous user manual versions please contact Ion Science Ltd.			
3.0	Page 15 – Removed temperature icon	19/04/2013	V0.4.20	V 1.0.0.70
3.1	SW & FW upgrade SPAN 2 adjusts to 5,000 ppm.	23/07/2013	V0.4.22	V 1.0.0.73
3.2	Accessory clarification 861443/5/OV-04 and A861474. Page 41	13/02/2014	V0.4.22	V 1.0.0.73
3.3	Instrument warranty text amended to direct customers to the serial number on the front label of the instrument – not the IRN number Page 42	12/08/2014	V0.4.28	V 1.0.0.73
	Tiger PC software updated	23/12/2014	V0.4.28	V 1.0.0.75
	Declaration of conformity updated and warnings in French added	19/06/2015	V0.4.33	V1.0.0.76
3.4	New inlet probe pages 38,41 and 42.	27/01/2016	V0.4.33	V1.0.0.77
3.5	Added torque setting page 39	15/04/2016	V0.4.33	V1.0.0.77
3.6	MiniPID changed to MiniPID 2 throughout. Declaration of Conformity page 5. US postal address page 44. Responsibility for use page 8.	28/04/2016	V0.4.33	V1.0.0.77
3.7	Front cover image updated– Page 1 Display description - page 12 Alarm latch description - page 24 Run time - page 18 TigerPC access – page 19 Remove installation screens – pages 19 & 20 Lock function - page 24 Clock sync - page 25 Soft menu - page 26 Data log sleep - page 26 License agreement – page 32 Cal kit + images - page 38 Cal image - page 39 Exploded diagram - page 42 Detection ranges + dimensions - page 45	30/11/2016	V0.7.05	V1.0.0.89

	<p>Update table – page 46</p> <p>User manual part number – page 47</p> <p>Part descriptions updated – page 37, 39, 42, 43</p> <p>Specification updated – page 44</p>			
3.8	<p>Windows 8 and Windows 10 – Page 18</p> <p>Add MiniPID spring to accessories – page 42</p> <p>Modified detection range – page 44</p>	27/06/2016	V0.7.05	V1.0.0.89
3.8R	Logo only	01/08/2017	V0.7.05	V1.0.0.89
3.9	<p>General manual update</p> <p>All formal references to Tiger in Warnings/official text changed to PhoCheck Tiger</p> <p>Updated replacement battery information</p> <p>Updated Declaration of Conformity</p> <p>Text changes on p10 Turn Off, Rechargeable batteries, Select the gas, p13 Flashlight/Torch, p16 Peak Hold, p17 Calibration Section, p22 Features Section, p24 Clock, p25 Tiger PC Software, p27 Calibration, p28 Firmware, p32 Snapshots screen, p38 Diagnostics Section, p39 Calibration Section, p40 Maintenance Section – PTFE Filter Disc, p42 part number amendments, p44 Accessories, p46 Service Tiger PC Software Section – text changes and old image removed – page 19</p> <p>Tiger PC Software – new image – page 20</p> <p>Tiger PC Software – images updated to match Select User Manual – page 23</p>	23/08/2018	V0.8.11	V1.0.1.11
3.10	<p>Update to new branding</p> <p>Added FW / SW changes &amp; updates:</p> <p>Tiger PC Software V1.0.1.16</p> <ul style="list-style-type: none"> <li>•Tiger PC user lock – Basic / Advanced modes</li> <li>•NEW Data log options – single, max, average</li> <li>•Tiger PC configuration page – INRS – VME</li> </ul>	09/04/2020	V0.8.14	V1.0.1.16

	<p>and VLE alarms</p> <ul style="list-style-type: none"> <li>• Start-up text now 'Instrument ID'</li> <li>• Configuration settings – save or load from file</li> </ul> <p>Tiger firmware V0.8.14</p> <ul style="list-style-type: none"> <li>• Gas name displayed on main running screen</li> <li>• NEW Data log options – single, max, average</li> <li>• Calibration function appears as CAL in main soft key menu</li> <li>• Option to skip span 2 in custom calibration</li> <li>• Time &amp; date can be adjusted from device</li> </ul>			
4.0	<ul style="list-style-type: none"> <li>• Added Tiger 11.7 eV technical spec</li> </ul>	23/10/2020	V0.8.14	V1.0.1.16
4.0R	Declaration of Conformity update	31/12/2020	V0.8.14	V1.0.1.16