



# CUB 10.6 eV, Cub 11.7 eV and CUB<sup>TAC</sup>

Instrument User Manual V2.5

---



Register  
your instrument  
online to receive your  
extended Warranty.

## **Register your instrument online for extended warranty**

Thank you for purchasing your ION Science instrument.

The standard warranty of your instrument can be extended to two years.

To receive your extended warranty, you must register your instrument online within one month of purchase (terms and conditions apply.)

Visit [www.ionscience.com/usa](http://www.ionscience.com/usa)



## Contents

<b>1. Safety .....</b>	<b>6</b>
Legal Notices Regarding the Safe Operation of Equipment .....	6
Symbols.....	6
Warnings, Cautions and Information notifications .....	6
Disposal.....	9
<b>2. Product Overview .....</b>	<b>9</b>
Cub Doc Docking Stations.....	10
<b>3. How do I use the device?.....</b>	<b>12</b>
Recharging your Cub.....	12
Switching on your Cub.....	13
Switching your Cub off.....	13
The Cub Display - Overview .....	14
Display Screens .....	14
<b>4. What do the alerts and alarms mean?.....</b>	<b>16</b>
<b>5. Using the CubPC Software and Downloading Data .....</b>	<b>17</b>
Overview.....	17
PC Requirements .....	17
Downloading and Installing .....	17
Connecting Docking Stations and Cubs to a PC.....	17
Starting the CubPC Software .....	18
Downloading Data Logged Readings .....	18
Main Menu Buttons.....	18
The Cubs Page.....	19
Viewing Download Records .....	20
Viewing Details of Logged Data .....	21
Saving Logged Data to a CSV File .....	22
Archive Cub Records .....	22
Delete Logged Data.....	22
Upgrading Firmware and Software .....	23
The Help Page .....	23
Getting Help.....	23



Upgrading the Software.....24

Other Facilities .....24

The Preferences Page .....24

    Actions on Dock .....25

    History.....25

    Calibration.....25

    Bump Test .....25

    CubPC Lock.....26

Dock Page .....26

**6. Device Configuration ..... 27**

    Name .....27

    Units.....27

    Auto Start.....27

    Clock.....27

    Data log.....28

    Calibration .....28

    Features .....28

    TWA STEL.....28

    Sound .....29

    Vibrate .....29

    PID.....29

    Alarms .....30

    Screens.....30

    Send to Instrument.....30

**7. Calibration ..... 31**

    Calibration Facility .....31

    Calibration Overview .....31

    Cub Calibration Settings .....31

    Calibration Using a Cub Doc .....32

        Cub Doc Calibration Settings .....32

        Cub Doc Calibration Procedure .....32

    Remote Calibration.....33

        Remote Calibration Procedure .....34



**8. Maintenance..... 35**

- Firmware and Software Updates.....35
- Filter Replacement .....35
- Water Ingress.....36
- Lamp Cleaning and Electrode Stack Replacement .....36
  - When to Clean or Replace the Lamp .....36
  - When to Replace the Electrode Stack .....37
  - Removing the MiniPID Sensor .....37
  - Replacing the MiniPID Electrode Stack.....37
- Lamp Removal and Examination .....38
  - Lamp Cleaning.....38
  - Replacing a Lamp .....40
- Bump Testing .....40

**9. Troubleshooting..... 42**

- Diagnostics.....42

**10. Appendix and Supporting Documents ..... 43**

- EU Declaration of Conformity.....43
- Technical Specifications.....43
  - Cub Specifications.....44
  - Cub Doc Power Supply Requirements .....45
- Warranty.....46
- ION Science Contact Details .....47
  - UK and Head Office.....47
  - USA Office .....47
  - German Office.....47
  - Italian Office .....47
  - French Office.....47
  - Chinese Office .....47

## 1. Safety

### Legal Notices Regarding the Safe Operation of Equipment

- While every attempt is made to ensure the accuracy of the information contained in this manual, ION Science accepts no liability for errors or omissions in the manual, or any consequences deriving from the use of information contained herein. It is provided “as is” and without any representation, term, condition or warranty of any kind, either expressed or implied.
- To the extent permitted by law, ION Science shall not be liable to any person or entity for any loss or damage which may arise from the use of this manual.
- We reserve the right at any time and without any notice to remove, amend or vary any of the content which appears in this manual.

### Symbols



**WARNING!**  
USED TO INDICATE DANGER WARNINGS WHERE THERE IS A RISK OF INJURY OR DEATH.



**Caution**  
Used to indicate a caution where there is a risk of damage to equipment.



**Information**  
Important information or useful hints about usage.



**Recycling**  
Recycle all packaging.



**WEEE Regulations**  
Ensure that waste electrical equipment is disposed of correctly.

### Warnings, Cautions and Information notifications

The following Cautions apply to the product described in this manual.



Inadequate performance of the gas detection equipment described in this manual may not necessarily be self-evident and consequently equipment must be regularly inspected and maintained.



ION Science recommends that personnel responsible for equipment use institute a regime of regular checks to ensure it performs within calibration limits, and that a record be maintained which logs calibration check data.



The equipment should be used in accordance with the safety standards and installation instructions given in this manual, and in compliance with local safety standards.



Li-Ion Batteries can be damaged if left in a discharged state. Please recharge Cub if battery indicator is showing empty. Please note also that if Cub is left for one year unused, the instrument needs to be charged fully before it can continue to be kept in storage. Please repeat annually.



Protect the PID sensor from exposure to silicone vapors as this may foul the windows of the lamps and reduce response to some gases. This can usually be remedied by polishing the lamp window with alumina powder.



Do not use abrasive or chemical detergents to clean the Cub instrument as this may reduce the antistatic properties of the materials used, clean it using a damp cloth only.



The Cub must not be exposed to atmospheres known to have an adverse effect on Thermoplastic Elastomers or Polycarbonate.



The Cub and Docking Station must be serviced in a Non-Hazardous environment and by ION Science Inc. authorized service centers only. Substitution of components may impair intrinsic safety.



Ingress Protection: Continuous exposure to wet weather conditions should be limited to less than one day and harsh water spray conditions should be avoided.



Proper Use: If the equipment is used in a manner not specified by the manufacturer, the protection provided by the equipment may be impaired.

The following Warnings, Cautions and Information notifications appear later in this manual where they are applicable.



**THE CUB IS A RECHARGEABLE DEVICE AND SHOULD ONLY BE RECHARGED USING THE ION SCIENCE DOCKING STATION IN A NON-HAZARDOUS ENVIRONMENT.**



**IF AN ALARM STATE IS TRIGGERED THE USER SHOULD LEAVE THE HAZARDOUS ENVIRONMENT AND ACT IN ACCORDANCE WITH NATIONAL SAFETY REGULATIONS.**



**THE CLEANING COMPOUND CONTAINS ALUMINIUM OXIDE AS A VERY FINE POWER. THIS MAY CAUSE IRRITATION OF RESPIRATORY TRACT AND EYES. (CAS Number 1344-28-1).**



Two spring loaded charging pins are located on the top of the Docking Station. Do not short circuit these two connections together else the internal fuse will blow, and the Docking Station will need to be replaced.



The Cub is a sensitive detector. Internal components must be handled with clean hands and clean tools. The Cub Lamp is fragile. Handle with great care. Never touch the window and do not drop.



**Never refit a damaged Lamp.**



**The instrument MUST be re-calibrated after fitting a replacement or cleaned Lamp.**



The portable Cub has been designed and certified Intrinsically Safe.



Cub instruments leave the factory with the battery fully charged. However prolonged periods of storage may result in the battery discharging. We recommend charging the instrument for at least four hours before use.



If multiple Docking Stations are connected, it may not be obvious on the page which is which. In order to identify a unit, click in one of the **Status** fields. The Charge and Diagnostic LEDs on that Docking Station will flash purple for a few seconds



**Important note:** The delete function deletes all logged data from a Cub. Ensure any data you need to edit is exported in CSV format before selecting this option.



Upgrading the firmware of a Cub will result in all logged data on that Cub being deleted.



**Important note:** Once the Cub memory has been completely filled, the oldest data will automatically be over-written with new data logs. The data will be reassembled as one complete data set, starting at the oldest available data points.



**Important note:** The use of Silicon pipe should be avoided as VOC gases can permeate the walls of the pipe.



**Important note:** Always check the calibration in normal running before use by carrying out a bump test. Apply the same Zero and SPAN gas used to calibrate and ensure the correct readings are displayed.



With the Filter Disc, Filter Disc O Ring and upper O Ring correctly fitted the Cub has an IP rating of IP65 (independently tested by BASEEFA).  
With the Filter Disc and O Rings removed, the IP rating drops to IP64.



## Disposal

- The equipment does not include any toxic materials, but if it has been contaminated by toxic materials, then exercise due care and follow the appropriate regulations when disposing.
- Always adhere to local regulations and procedures when disposing of the equipment.
- Ion Science Inc. offers a take back service. Please contact us for more information.



### RECYCLING

Recycle all Packing.



### WEEE REGULATIONS

Ensure that all waste electrical equipment is disposed of correctly.

## 2. Product Overview

The **Cub** is a personal VOC detector with photoionization detection (PID) technology for the fast, accurate detection of volatile organic compounds, keeping you safe within your working environment. It utilizes a humidity resistant and anti-contamination design providing accurate results and an extended run-time in the most challenging environments.

With the option for parts-per-billion (ppb) sensitivity, Cub sits within the breathing zone and is comfortable and unobtrusive to wear. The Cub 10.6 eV has a dynamic range of 0 to 5000 ppm and can measure 480 selectable compounds.

When worker exposure exceeds a Cub's programmed limits, its audible, vibrating and flashing LED alarms alert the worker to the gases present. Readings are displayed on a bright, back-lit LCD display with selectable data logging time.

The Cub 10.6 eV is available as a standard instrument with 10.6 eV lamp for accurately detecting a wide range of volatile organic compounds (VOCs) to parts-per-million (ppm) levels. ION Science also offers the **CubTAC** ppm variant with 10.0 eV lamp that accurately detects total aromatic compounds (TACs), including benzene. The newest Cub variant from ION Science is the Cub 11.7. The Cub 11.7 is capable of detecting other gases such as Acetylene, Methanol and Formaldehyde.

Both models can be upgraded with parts-per-billion (ppb) sensitivity quickly and easily online.



The portable Cub has been designed and certified Intrinsically Safe.



- 1 Rubber multi-function push button.
- 2 LCD display.
- 3 Alarm Sounder.
- 4 PID (Photoionization Detector).
- 5 Clip and D-ring loop.

### Cub Doc Docking Stations

The Cub is used with **Cub Doc** Docking Stations. These are used to recharge your Cub. Depending on which model of Docking Station you use, they can also be used to download data from your Cub, and to calibrate it.

Cub Docs are equipped with coloured LEDs to indicate battery, connection, and calibration status.

There are three types of Cub Docs:

Cub Doc Type	Charges device	LED status indicators	USB connection	Calibration
Charge Dock	✓	✓		
Data Dock	✓	✓	✓	
Calibration Dock	✓	✓	✓	✓



- |  |   |
|--|---|
| <ul style="list-style-type: none"> <li>1 Cub dock.</li> <li>2 Diagnostic LED.</li> <li>3 USB LED.</li> <li>4 Charge LED.</li> <li>5 Flying socket for mains power connection.</li> </ul> | <ul style="list-style-type: none"> <li>6 12V DC socket.</li> <li>7 USB socket (not on Charge Dock).</li> <li>8 Socket for "daisy chaining" (see next page).</li> <li>9 Fuse socket.</li> <li>10 Gas calibration ports (Calibration Dock only).</li> </ul> |
|--|---|

### 3. How do I use the device?

#### Recharging your Cub



**THE CUB IS A RECHARGEABLE DEVICE AND SHOULD ONLY BE RECHARGED USING THE ION SCIENCE DOCKING STATION IN A NON-HAZARDOUS ENVIRONMENT.**

Your Cub should be recharged before every use.



**Two spring loaded charging pins are located on the top of the Docking Station. Do not short circuit these two connections together else the internal fuse will blow, and the Docking Station will need to be replaced.**



Cub instruments leave the factory with the battery fully charged. However prolonged periods of storage may result in the battery discharging. We recommend charging the instrument for at least four hours before use.

Cubs are recharged using a Cub Doc Docking Station (all types).

Cub Docs can be “daisy-chained” together (see below) so that multiple Cubs can be recharged from a single power point:

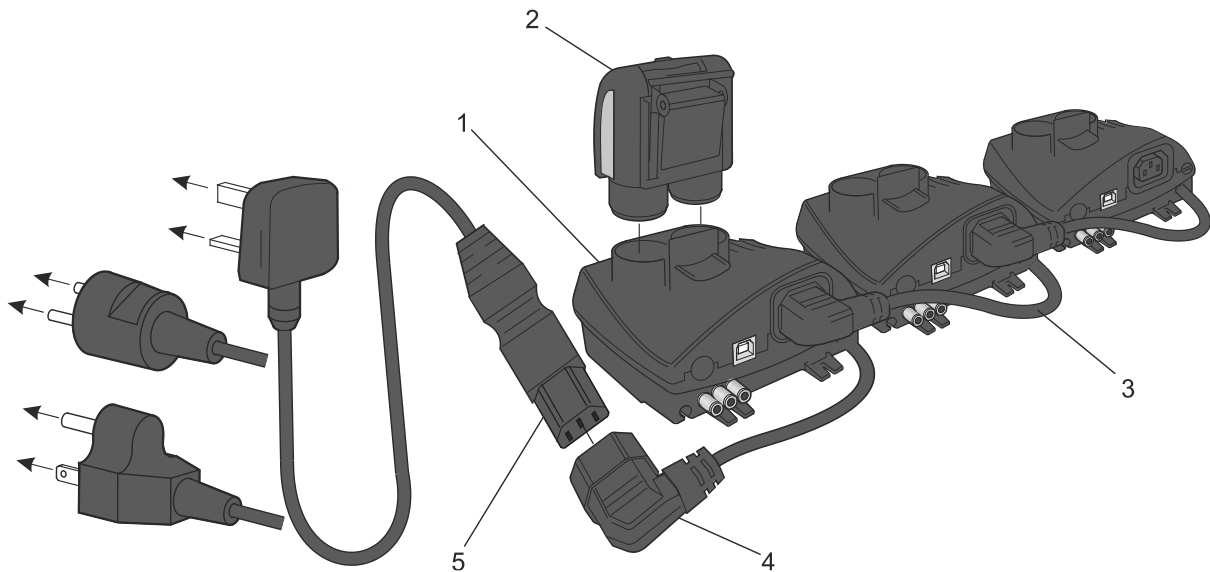

- |                                     |                             |
|-------------------------------------|-----------------------------|
| 1 Cub Doc.                          | 4 Flying socket.            |
| 2 Cub.                              | 5 3-core power supply lead. |
| 3 Docking Stations “daisy chained”. |                             |

To charge your Cub, place it on a Cub Doc which is connected to mains power. The Charge LED of the Docking Station will indicate green if power is available.

The Cub will then begin to charge. While the Cub is charging, the screen will be illuminated with a yellow light. When the Cub is fully charged, the screen will be illuminated with alternating green and yellow light.



Battery empty

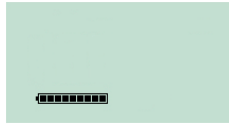

Battery fully charged

While the Cub is connected to a Docking Station, the screen will display the level of charge.

### Switching on your Cub

To switch on your Cub, hold down the rubber multi-function button on top of the device for 3 seconds.

An alarm will sound and the LEDs on front of the devices will light-up red. A progress bar will be displayed in its bottom-left corner, with segments being added from the bar from right to left.

Hold down the multi-function button until this is no longer displayed (i.e. for 3 seconds). The alarm will then stop sounding and the red LED will turn off.

The screen will turn on and will cycle through various displays as the device sets itself up.

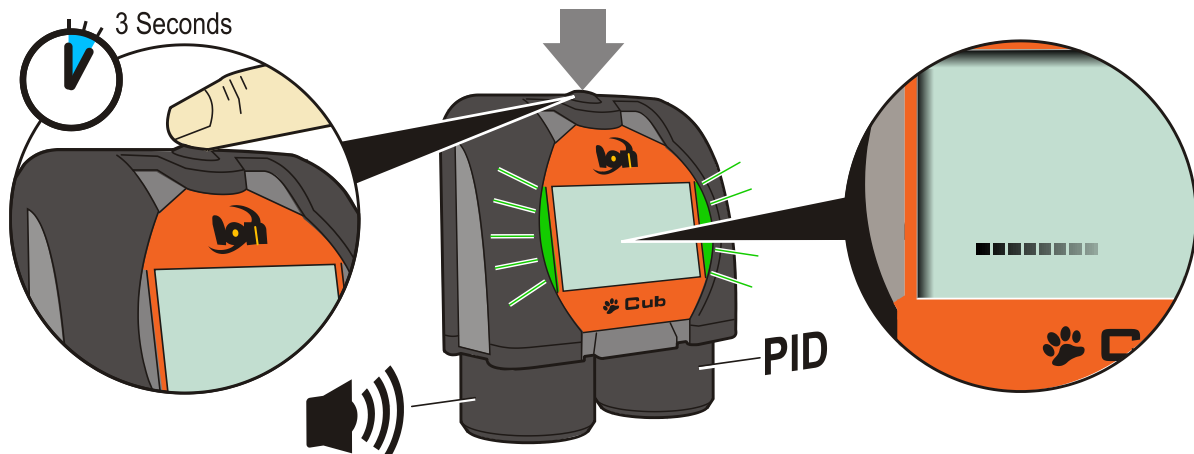

Finally, a short alarm will sound, and the LEDs will flash green. The main gas detection display screen (see below) will then be displayed. Your Cub is now ready to use.

### Switching your Cub off

Press and hold down the multi-function button on top of the device. A progress bar will be displayed in the bottom-left corner of the screen with segments being removed from the bar from right to left until the screen and the device switch off.

## The Cub Display - Overview

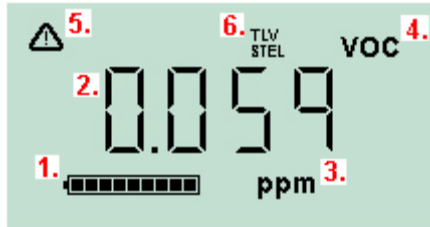

- 1 Battery charge indicator.
- 2 Detected gas level.
- 3 Gas level units (**ppm** or **mg/m<sup>3</sup>**, depending on how the Cub is configured).
- 4 This indicates the gas sensor type selected, e.g. **VOC** or Volatile Organic Compounds.
- 5 This symbol appears when a STEL or TWA alarm is exceeded.
- 6 If the **TLV STEL** icon is present, on-going calculated values are being displayed.

## Display Screens



**IF AN ALARM STATE IS TRIGGERED THE USER SHOULD LEAVE THE HAZARDOUS ENVIRONMENT AND ACT IN ACCORDANCE WITH NATIONAL SAFETY REGULATIONS.**

The Cub can display a number of different data screens. To cycle through these screens, press the multi-function button on top of the Cub. When a new screen is accessed the display is illuminated with a different colored light, which will turn off after a few moments.

When the display is already lit up, a different screen is displayed every time the multi-function button is pressed (except when an alarm has been triggered - [see below](#)). If the display is not lit up, the multi-function button must be pressed once to light it up and then again to show the next screen.



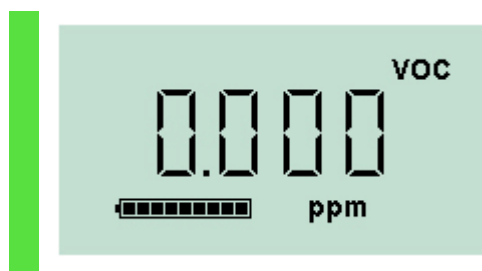

The screens are listed below in the order that they are accessed.

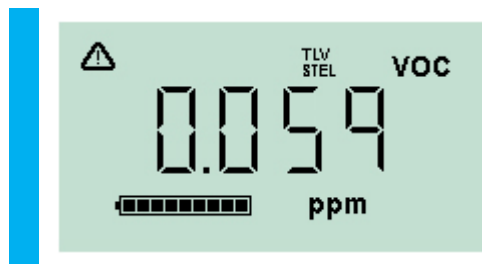

Main gas detection display screen.  
Displayed by default when a Cub is turned on.

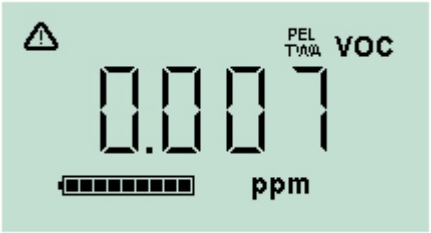

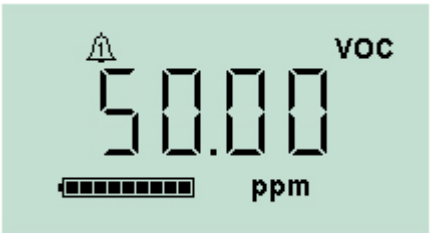
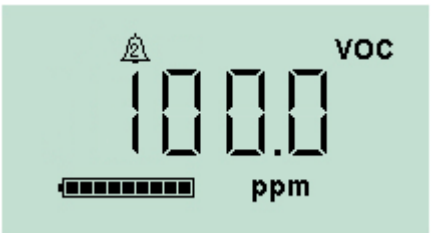
Displays the on-going live TLV / STEL.

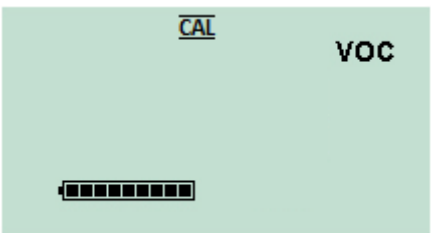
	<p>Displays the on-going live PEL / TWA calculation.</p>
	<p>Displays the current time.</p>
	<p>Displays the low alarm level set for the Cub.</p>
	<p>Displays the high alarm level set for the Cub.</p>
	<p>Displays the current temperature.</p>
	<p>This screen is used when calibrating the Cub remotely, i.e. without the use of a Cub Doc. Refer to <a href="#">Calibration</a> for details.</p>

Note that a Cub can be configured to only display specific screens (see the [Device Configuration](#) section for details).

The next multi-function button press will cycle the display back to the main gas detection display screen.

#### 4. What do the alerts and alarms mean?



**IF AN ALARM STATE IS TRIGGERED THE USER SHOULD LEAVE THE HAZARDOUS ENVIRONMENT AND ACT IN ACCORDANCE WITH NATIONAL SAFETY REGULATIONS.**

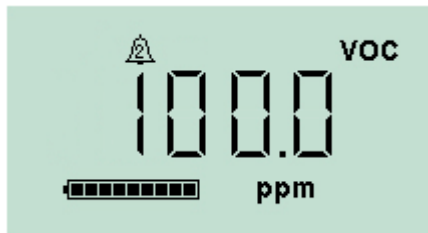

If the detected gas level triggers a high-level alarm, the display screen and the lights on the top of the unit will flash red.

The high-level alarm symbol will be displayed on the screen.

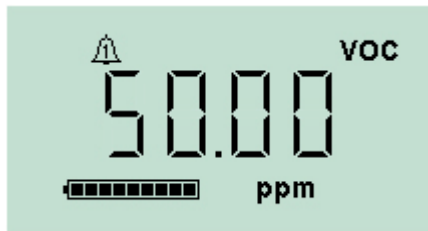

If the detected gas level triggers a low-level alarm, the display screen will flash orange, and the lights on the top of the unit will flash red.

The low-level alarm symbol will be displayed on the screen.

Depending on how the Cub was set up, an alarm may also sound, and the unit may vibrate.

If the alarm latch is set, these alarm indications cannot be switched off until the gas level has dropped below the alarm threshold. Otherwise, pressing the multi-function button once will turn off the alarm sound and vibration.

The alarm lights will continue to flash. Pressing the multi-function button, a second time will stop the alarm lights flashing, however, they will start to flash again if the gas level goes above the alarm threshold.



## 5. Using the CubPC Software and Downloading Data

### Overview

The CubPC software is used to carry out the following procedures on a PC:

- View Cub details and downloaded statistics.
- Set preferences for Cubs.
- Calibrate Cubs.
- View details of and set preferences for Cub Docs.

### PC Requirements

CubPC software is run on a PC using Windows Vista, Windows 7 or Windows 10. The PC must have .NET Framework 3.5 Service pack 1 or above installed.

### Downloading and Installing

Download the CubPC software from our website at:

[www.ionscience.com/usa](http://www.ionscience.com/usa)

### Connecting Docking Stations and Cubs to a PC

Connect your PC to either a Cub Doc Data Dock or Calibration Dock using the provided USB cable as shown below:

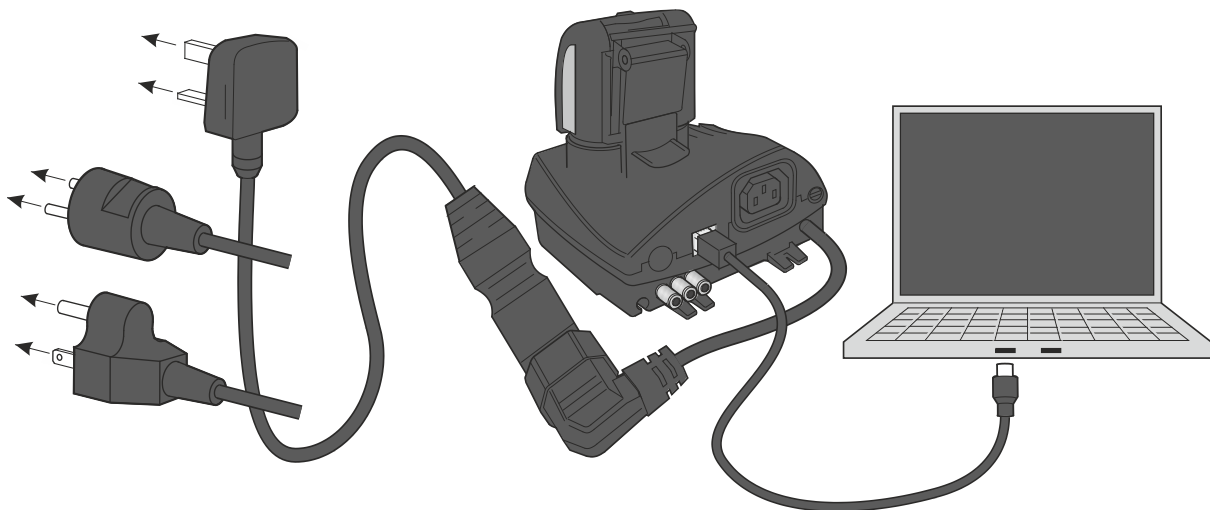

The Cub Doc must be powered on (the Charge LED should be green) for a USB connection to be made.

Mains cables for the US, EU and Australia are also available.

The USB LED on the Cub Doc will be:

- Red when there is a physical USB connection but communication with the PC has not been established.
- Yellow once communication is established and the Docking Station and the PC are communicating, e.g. while logged data from the Cub is transferred to the PC.
- Green once communication is established.

When a Docking Station is first connected to a PC on which the CubPC software has been installed, the installation of the device driver software will be triggered.

Multiple Docking Stations can be connected to a PC via a USB hub.

### Starting the CubPC Software



Run the software from the CubPC .exe file in the folder you installed it in, or by pressing the desktop or Start Menu shortcut.

The CubPC splash screen will then be briefly displayed. CubPC then opens, with the **Cubs** page displayed.

### Downloading Data Logged Readings

When you connect your Cub to a PC as described previously, any fresh data logged readings will be automatically downloaded as the software 'reads' your Cub. While this is happening, the PC LED on the Docking Station will change to yellow.

### Main Menu Buttons

These buttons are displayed at the top of the CubPC window, whichever page you are viewing:



Opens the [Cubs page](#).



Opens the [Help page](#), which displays general information on the CubPC software and provides access to technical support and documentation.



Opens the [Preferences page](#), used to set preferences for the CubPC software, such as actions taken when Cubs are docked.



Opens the [Dock page](#), used to view details of the connected Cub Docs and perform purges and firmware updates.



Used to browse backward and forward through the CubPC pages you have viewed.



Used to exit from and close CubPC.

## The Cubs Page

The **Cubs** page is displayed when CubPC is opened. It lists the currently and previously connected Cubs.

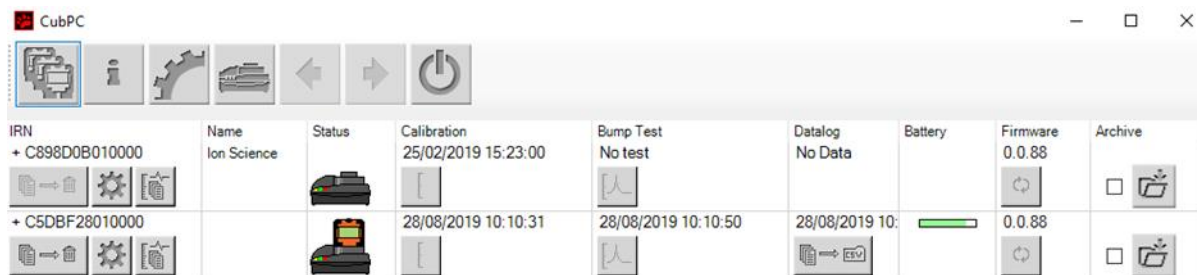

To open the **Cubs** page from another page, click this button:



If multiple Docking Stations are connected, it may not be obvious on the page which is which. In order to identify a unit, click in one of the **Status** fields. The Charge and Diagnostic LEDs on that Docking Station will flash purple for a few seconds

If a Cub is connected to a Cub Doc Docking Station, this is indicated by its picture under the **Status** heading:

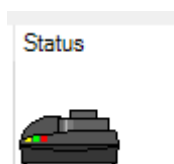

No Cub connected.



Cub connected.

For each connected Cub, the following are displayed:



- 1 Cub IRN number.
- 2 Cub name (if assigned on the [Device configuration page](#)).
- 3 Cub Doc status.
- 4 Time and date that the Cub was last calibrated.
- 5 Time and date that the Cub was last bump tested.
- 6 Time and date of the last data log transfer from the Cub and the access to data logs.
- 7 Battery charge status of the Cub.
- 8 Firmware version on the Cub.
- 9 Option to [Archive Cub records](#) and remove the Cub from the list.

The **Cubs** page also includes for each Cub buttons to:

- [View records of data downloads.](#)
- [View the downloaded data itself.](#)
- [Save logged data to CSV files.](#)
- [Delete logged data.](#)
- [Open the Cub Configuration page.](#)
- [Calibrate Cubs.](#)
- [Perform Bump Tests.](#)
- [Update the Cub firmware.](#)

Additional data and facilities for a Cub can be displayed or hidden by clicking the + / - symbols next to the serial number of that Cub. The additional details are then displayed:

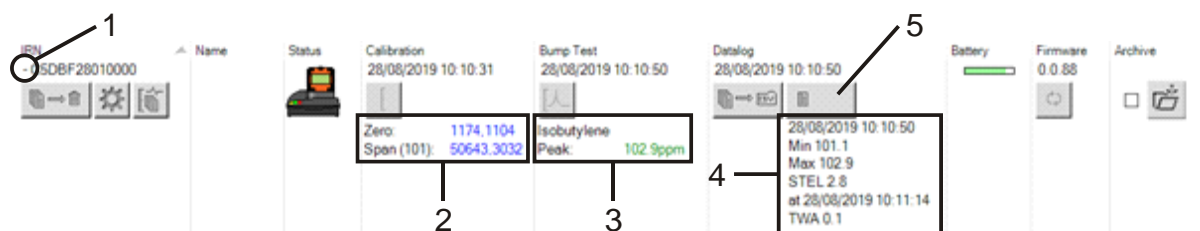

- 1 +/- control.
- 2 Calibrated zero and span AD values.
- 3 Bump test gas used and peak.
- 4 Minimum, maximum, STEL and TWA levels recorded in the last data log. You can scroll up/down between data logs.
- 5 Button to [access the selected data log.](#)

### Viewing Download Records



To view the list of data downloads from a Cub, click this button for the Cub:

The following page is then displayed:

Name	Calibration	Bump Test	Datalog	Firmware
C5DBF28010000 - 28/08/2019 10:15:54	28/08/2019 10:10:31 Zero: 1174.1104 Span (101): 50643.3032	28/08/2019 10:10:50 Isobutylene Peak: 102.9ppm	28/08/2019 10:10:50 28/08/2019 10:10:50 Min 101.1 Max 102.9 STEL 2.8 at 28/08/2019 10:11:14 TWA 0.1	0.0.88
+ 28/08/2019 10:19:34	28/08/2019 10:10:31	28/08/2019 10:10:50	28/08/2019 10:10:50	0.0.88

A record is displayed for each time the Cub has downloaded data to the PC.

The displayed download record data includes; time and date of each download, Cub name, Cub firmware version, calibration time and date, bump test time and date.

The **Datalog** column displays the time and date of the start of each data log and a button for [saving logged data to a CSV file](#).

To view additional log details, click + at the beginning of its row. The **Calibration** column then displays the zero and span levels that the Cub was calibrated to at the time and the **Datalog** column displays the minimum and maximum detected gas levels, and the detected STEL and TWA levels.

The **Datalog** column also displays an additional button [for viewing details of the logged data](#).

### Viewing Details of Logged Data

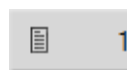

To view details of a data log, press this button in the **Datalog** column:

To view details of the most recent data log recorded by a Cub, press the same button on the **Cubs** page for that Cub. The number on the button indicates how many files are stored within the Cub.

The details of the reading recorded in the selected log are then displayed. For example:

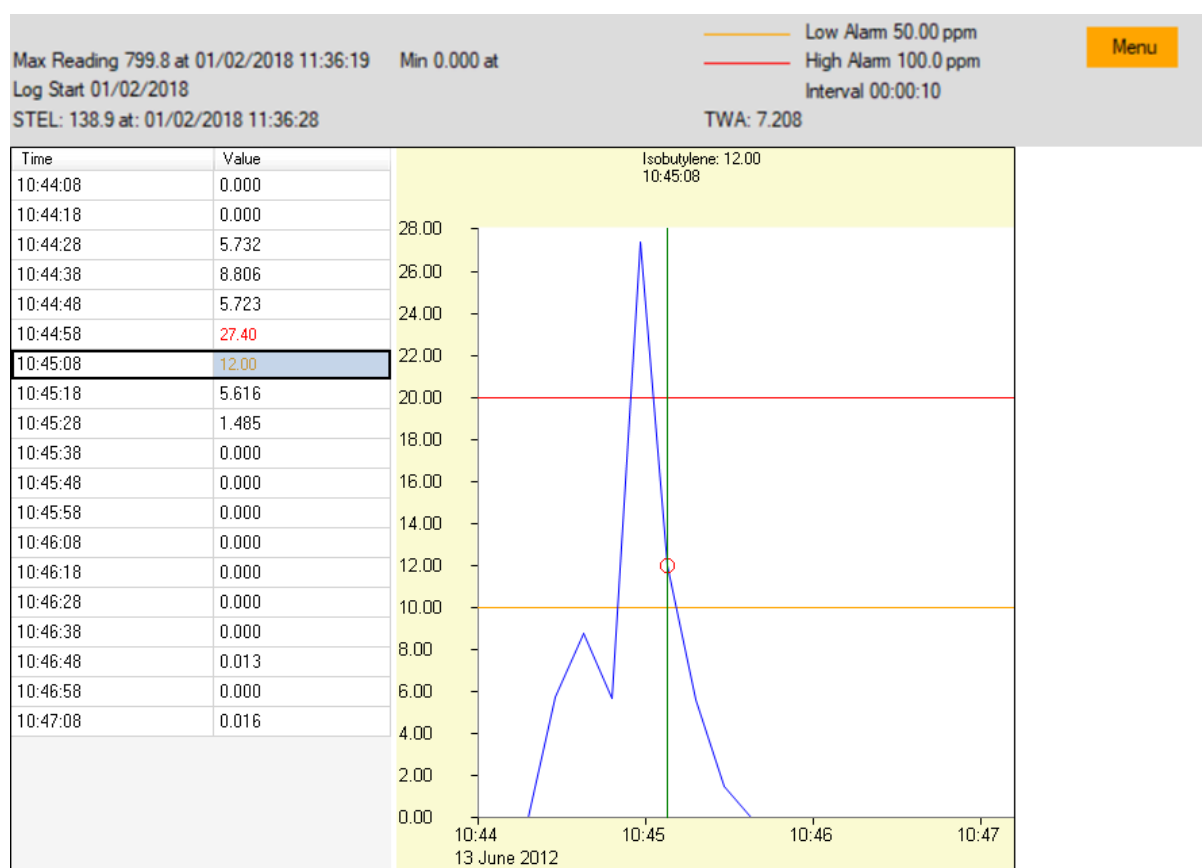

The top area displays the general details of the log and of how the Cub was configured at the time.

The left-hand area lists the time and gas level of each reading. Red values indicate that the reading has triggered a high-level alarm, orange values that the reading has triggered a low-level alarm.

The right-hand area displays a line graph of the readings. The blue line indicates the recorded gas level. The red and orange lines indicate the high and low alarm levels respectively.

If a record in the left-hand area is clicked on, a vertical green line is added to the graph to indicate the time of the reading. Above the line, the gas level at that time and exact time of the reading are displayed.

The **Menu** button displays the following options for printing, exporting and viewing the data:

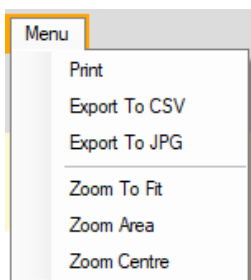

### Saving Logged Data to a CSV File

To save a data log to a CSV file, press this button in the **Datalog** column:



The option is also available on the above menu.

A standard Windows “Save As” type window is then displayed. Select a filename and location for the file in the usual way and click **Save**.

Note that data may automatically be saved to a CSV file when a Cub is connected to a docking station, if this option is specified on the [Preferences page](#).

### Archive Cub Records

To archive Cub data and remove it from the list of connected Cubs, tick its **Archive** checkbox and

click this button: 

The Cub data is then archived to the Instruments folder on the C: drive of the PC. The Cub is removed from the **Cubs** page list (unless connected to CubPC again).

### Delete Logged Data

To delete all logged data stored by a Cub, press this button:



A message is then displayed requesting that the deletion be confirmed. Once confirmed, the deletion will take place.



**Important note:** The delete function deletes all logged data from a Cub. Ensure any data you need to edit is exported in CSV format before selecting this option.

## Upgrading Firmware and Software

CubPC software updates are installed using the [Help page](#).

To update the Cub firmware, click this button on the [Cubs page](#) under the **Firmware** heading: 



Upgrading the firmware of a Cub will result in all logged data on that Cub being deleted.

If the firmware is up to date, nothing will happen. If a newer version is available, a progress indicator will be displayed in the **Firmware** field while the upgrade is in progress.

To update the Docking Station firmware, click the same button on the [Dock page](#).

## The Help Page

Click this button to open the **Help** page: 

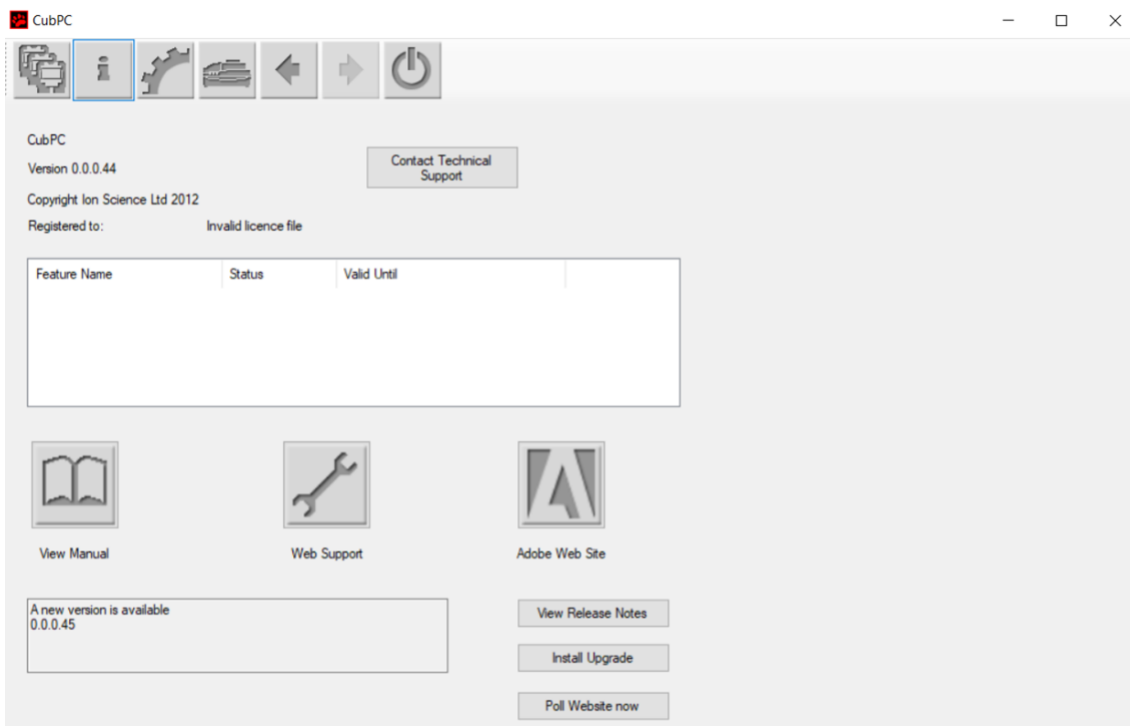

The current software version is displayed at the top of the page, along with copyright information, who is it licensed to, etc.

## Getting Help

The **View Manual** button accesses the manuals page on the ION Science website, from which this manual can be downloaded.

To send a question to Technical Support, click the **Contact Technical Support** button and complete the form that is displayed.

To access the ION Science Support web page, click the **Web Support** button.

### Upgrading the Software

If a newer version of the software is available, this is stated in the lower-left section of the page. To install the newest version, click **Install Upgrade**.

The install will then take place. The old version of the software will automatically shut down and be replaced by the new version, which will then start up automatically.

To view the release notes for the software, click **View Release Notes**.

To check whether an upgrade is available, click the **Poll Website now** button.

### Other Facilities

It is recommended that this manual is viewed using Adobe Reader. The **Adobe Web Site** button opens the Adobe Reader download page.

### The Preferences Page

Click this button to open the **Preferences** page:

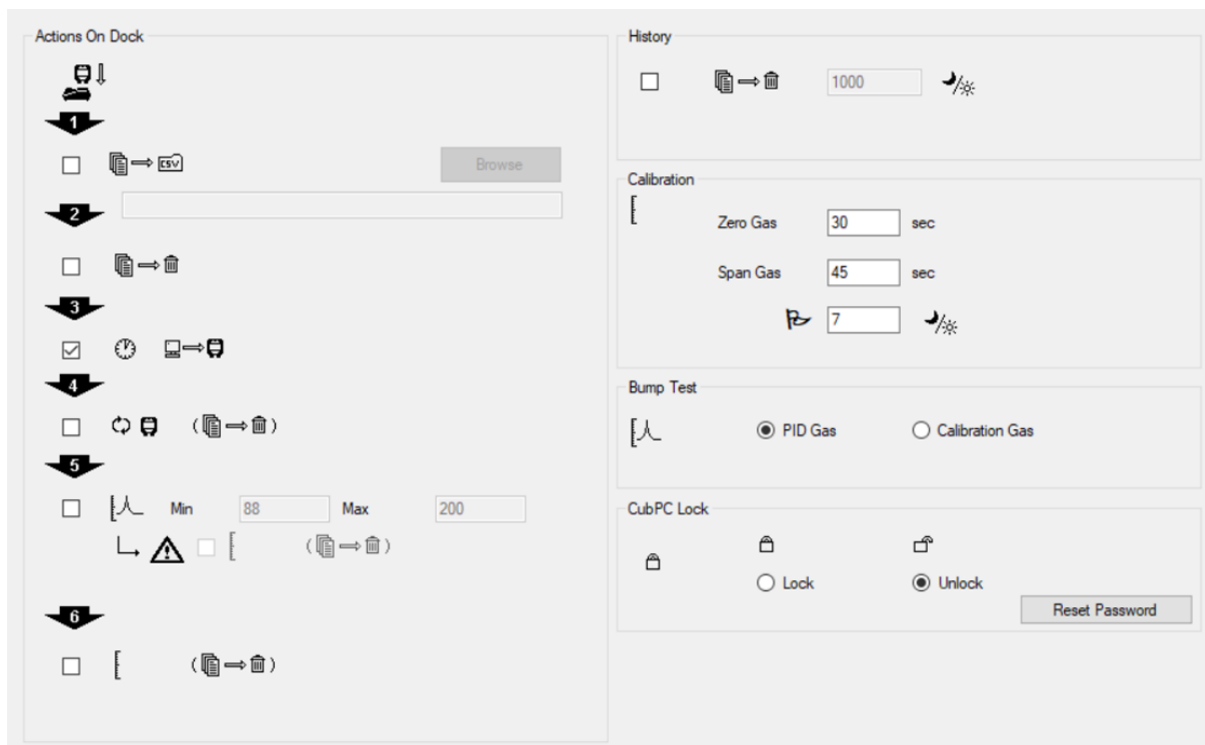

This page is used to set preferences for the CubPC software, such as actions taken when Cubs are docked.



## Actions on Dock

When you place a Cub in a Cub Doc Docking Station, logged data is automatically copied to the connected PC. Other actions may also take place, as specified by ticking the checkboxes in this section, in the order they are listed on the page.



Cub data is downloaded to PC in CSV format. The location for the file is selected using the **Browse** button.

Note that this function is in addition to the automatic copying of logged data mentioned above. Such data is viewed using CubPC but is encoded and cannot be edited. Data transferred manually to CSV files may be freely edited and also loaded by other software.



Data is deleted from the Cub once it has been downloaded to the PC.



The Cub's internal clock is synchronized to that of the PC.



The Cub's firmware is automatically updated if an update is available. **Data stored on the Cub will be deleted.**

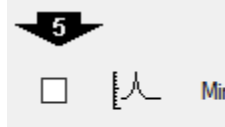

The Cub is automatically bump tested. **Data stored on the Cub will be deleted.**

Minimum and Maximum SPAN parameters can be set which, if exceeded, will automatically

recalibrate the Cub instrument. Check the  checkbox.

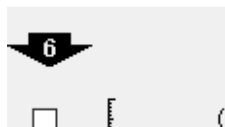

The Cub will be recalibrated. This function works independent of the previous bump test function. **Data stored on the Cub will be deleted.**

The last two actions are only available on Calibration Docking Stations.

## History

If logged data more than a certain number of days old is to be deleted from the PC, tick the checkbox in the **History** section of the page and enter the number of days in the field next to it.

## Calibration

Please refer to the [Calibration section](#) for details of these settings.

## Bump Test

Use this setting to specify whether during bump tests the bump gas used is the calibration gas or the PID gas selected for the Cub. [See the Bump Tests topic](#) for further details.

### CubPC Lock

CubPC can be locked by a master-user to prevent unauthorised adjustment of configuration or settings.

To lock CubPC, select the **Lock** option and enter your password. The default password for CubPC is 0000. The password can be changed using the **Reset Password** button.

If you have forgotten your password, please contact ION Science so that we can issue you with a master password. Master passwords are generated daily and are only valid on the day of generation.

### Dock Page

Click this button to open the **Dock** page: 

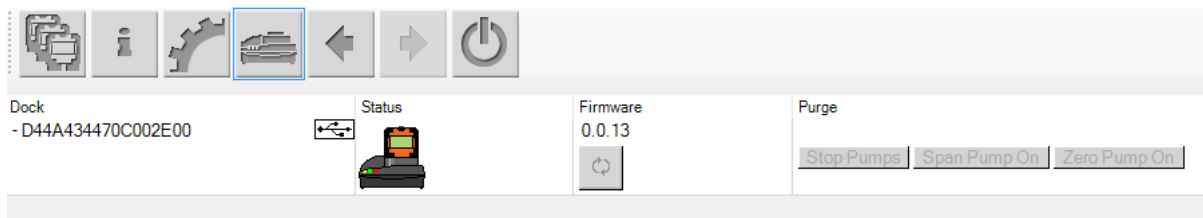

Use this page to view details of the connected Cub Docs and perform firmware updates on them:

- The **Dock** column displays the serial number of each Cub Doc.
- Click this symbol  to disconnect a Cub Doc.
- Refer to the [Cubs page](#) for details of the **Status** and **Firmware** columns.
- The **Purge** column buttons are for diagnostic use only.

## 6. Device Configuration

To configure a Cub, click this  button on the **Cubs** page for that Cub. The following page is displayed:

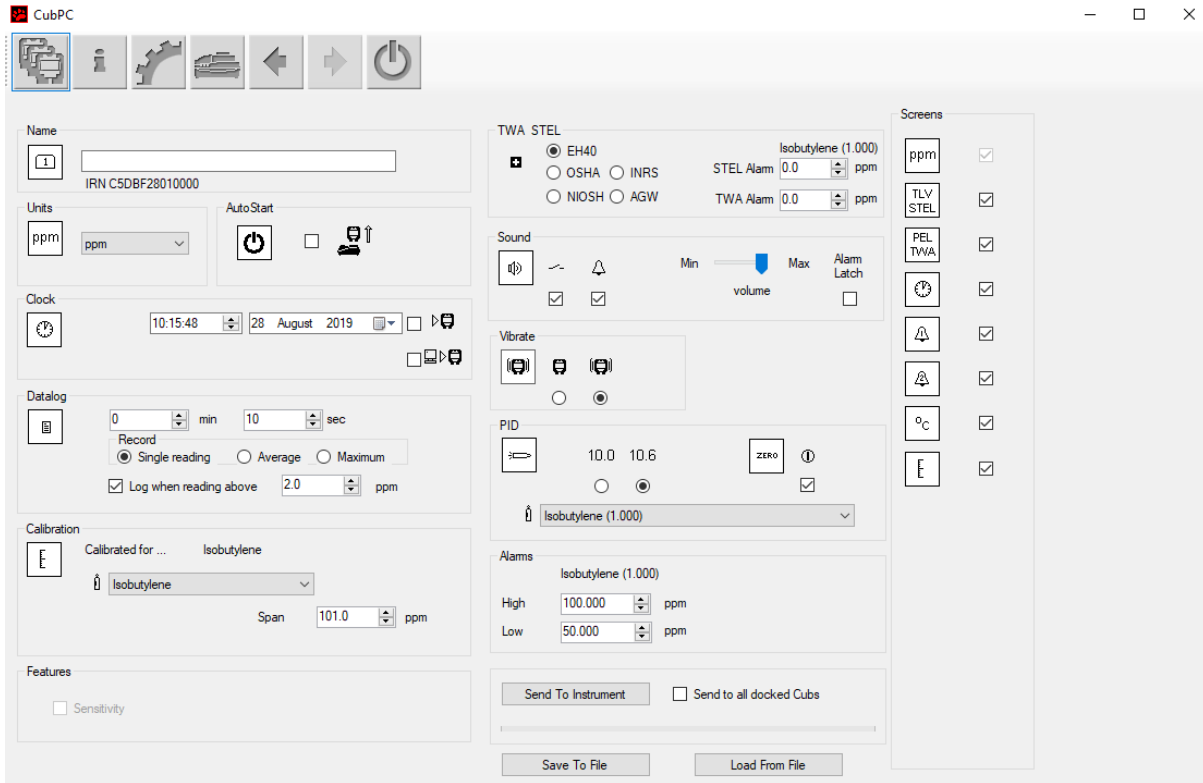

### Name



If required, enter a name for the Cub in this field.

### Units



The units of measurement may be chosen as parts per million (ppm) or milligrams per cubic meter (mg/m<sup>3</sup>).

### Auto Start



Tick the checkbox if the Cub is to start automatically when removed from the Docking Station.

### Clock



Set the time and date and tick the checkbox to the right of these fields  to set the time on your Cub.

Alternatively, tick the lower checkbox  to synchronize your Cub with the time on your computer.

### Data log



Use this area to set the interval between readings. The minimum time permitted is one second. Users can either select:

- **Single:** a data point is taken at the required sampling frequency, e.g. one live data point every 10 seconds
- **Average:** the average value of the data points recorded over the selected time frequency, e.g. the average concentration between readings
- **Maximum:** the maximum concentration between readings, taken over the selected time frequency

Cub can also be configured to start data logging once concentration levels reach a pre-defined level. Data logging will stop once values drop below this concentration. Recorded data will be displayed as one data session until the device is restarted. The exported csv file will also detail how many times the device reading exceeds the data log trigger level.

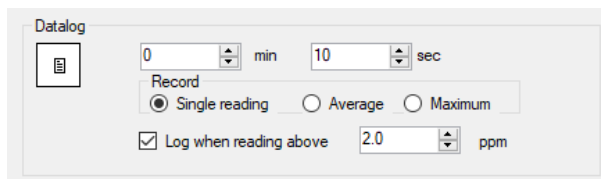

**Important note:** Once the Cub memory has been completely filled, the oldest data will automatically be over-written with new data logs. The data will be reassembled as one complete data set, starting at the oldest available data points.

### Calibration



Refer to the [Calibration section](#) for details of these settings.

### Features

PPM Cubs can be upgraded automatically to PPB via an internet connection. The customer can purchase an upgrade from his local distributor or supplier. Once the upgrade has been purchased the instrument must be connected to a computer running the CubPC software. The Cub instrument will then be automatically upgraded, via the internet connection.

### TWA STEL



Select the appropriate regulatory code to which you are working using the radio buttons.

In the **TWA Alarm** and **STEL Alarm** fields, users can enter a lower value (i.e. more stringent) than the default TWA and STEL alarm levels if required.

### Sound



Sound volume is adjusted with the slider.



If the **Switch** checkbox is selected the Cub will ‘beep’ whenever the multi-function button is pressed.

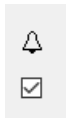

If the **Alarm** checkbox is selected the Cub’s user settable alarms will trigger when the alarm levels are exceeded.



**(checkbox ticked):** Multi-function button press does **not** switch off alarm when above the lower or upper alarm levels.

- When the alarm goes below the threshold, the alarm remains on until the multi-function button is pressed. First multi-function button press disables the sounder, second multi-function button press turns the LEDs off.
- The alarm activates again when the signal goes above the alarm level again.



**(checkbox unticked):** When the Cub has gone into alarm (signal > alarm level), the sounder and LEDs can be switched off - first multi-function button press disables the sounder, second multi-function button press then turns the LEDs off (as per current behavior).

- When the signal goes below the lower alarm, the alarm stops (LED and sounder).
- The alarm activates again when the signal goes above the alarm level again.

### Vibrate



Select the first radio button to set the Cub to not vibrate when there is an alarm. Select the second radio button to set the Cub to vibrate when there is an alarm.

### PID



Select the PID lamp type from the two options. Ensure that the lamp selected is the same as that fitted in your Cub.



To set the Cub to auto-zero during start-up check the checkbox. This is the default setting. To use the calibration zero instead, untick the checkbox. ION Science recommends using the default settings where possible.

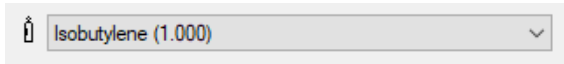

Select the type of gas and RF from the drop-down

list.

## Alarms

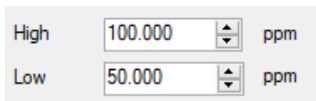

In this section enter the high and low alarm levels for the selected gas.

## Screens

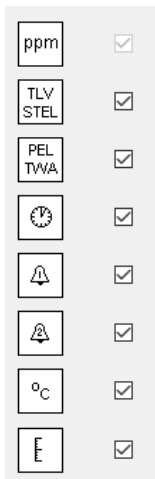

In this section tick or un-tick the checkboxes to specify which screens are displayed on the Cub. Refer to the [Display Screens topic](#) for further details.

## Send to Instrument

When you have entered the required configuration, send it to your Cub by clicking on the **Send to Instrument** button.

It is possible to send the same configuration file to multiple docked Cubs simultaneously by selecting the **Send to all docked Cubs** checkbox and then clicking on the **Send to Instrument** button.

- The USB LED on the Docking Station will change to yellow while the new settings are being downloaded to the connected Cub.

If the message “There was a problem sending to the instrument” appears:

- Exit the CubPC software.
- Restart the CubPC software.
- Repeat the Send to Instrument instruction.

- If your PC still fails to write to your Cub seek advice from your distributor or from ION Science Inc.

To save a configuration file for future use, select the **Save To File** button. Please note that the instrument name and time and date settings are not saved. To recover a saved configuration file so that it may be sent to a Cub(s), select the **Load From File** button and then **Send to Instrument**.

## 7. Calibration

### Calibration Facility

ION Science Inc. offers a calibration service including the issue of certification confirming calibration with equipment traceable to national standards. A calibration kit is available from your distributor, service center, or from the ION Science website:

[www.ionscience.com/usa](http://www.ionscience.com/usa)

ION Science Inc. recommends annual return of all instruments for yearly service and calibration.

### Calibration Overview

The Cub is calibrated at ION Science after manufacture; please note that subsequent calibration will overwrite the factory calibration. Cub instruments leave ION Science pre-set for gas type Isobutylene. Instruments are factory calibrated against isobutylene and all response factors are equivalent to this.

Due to the linear output of the ION Science PID detector, a two-point calibration is used. Cub scales its linear output across a ZERO level (clean air reference) and the SPAN 1 user defined gas concentration.

A Cub can be calibrated either by connecting it to a Calibration type Cub Doc, or remotely using a remote calibration adaptor.

### Cub Calibration Settings

Before calibrating a Cub, first set up the parameters on the [Configuration page in Cub PC](#):

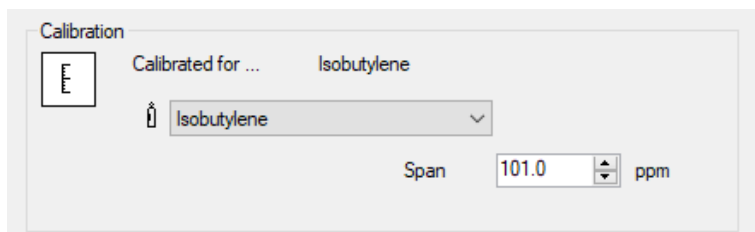

From the drop-down list, select the gas that the Cub is calibrated for.

To set the span that the Cub is calibrated for, enter the concentration in ppm in the **Span** field.

## Calibration Using a Cub Doc

### Cub Doc Calibration Settings

Before calibrating using a Cub Doc, first set up the parameters on the [Preferences page in Cub PC](#):

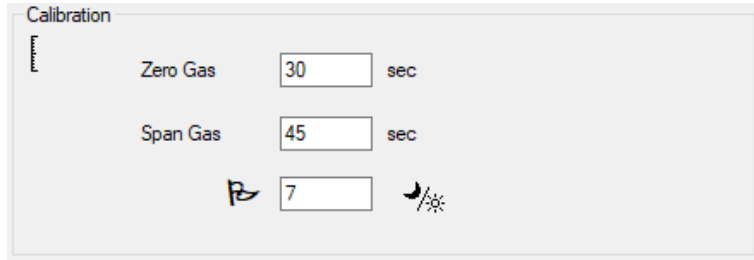

In both the **Zero Gas** and **Span Gas** fields enter the number of seconds that the Zero Gas and Span Gas are to be sent to a connected Cub when it is being calibrated.

To set a reminder to flag to user that a calibration is due for a Cub, enter the number of days that calibrations are valid in the bottom field. When a Cub is docked and read by CubPC, the Diagnostic LED on the Cub Doc will indicate as follows: red if there is no valid calibration, yellow if the calibration is out of date, and green if the calibration is current.

### Cub Doc Calibration Procedure

Ensure you have the cylinder(s) of gas, regulator(s) and / or a zero-carbon filter on hand before starting the procedure. Alternatively, a known clean air supply may be used as the 'zero' gas. Ensure you are familiar with the calibration procedure before starting.

1. Connect the Zero and Span gases by pushing 5mm Tygon pipes onto the calibration ports on the back of a Calibration type Cub Doc Docking Station. Connect the Zero gas to the left port (1) and Span gas to the right port (2) (the middle port is not used).

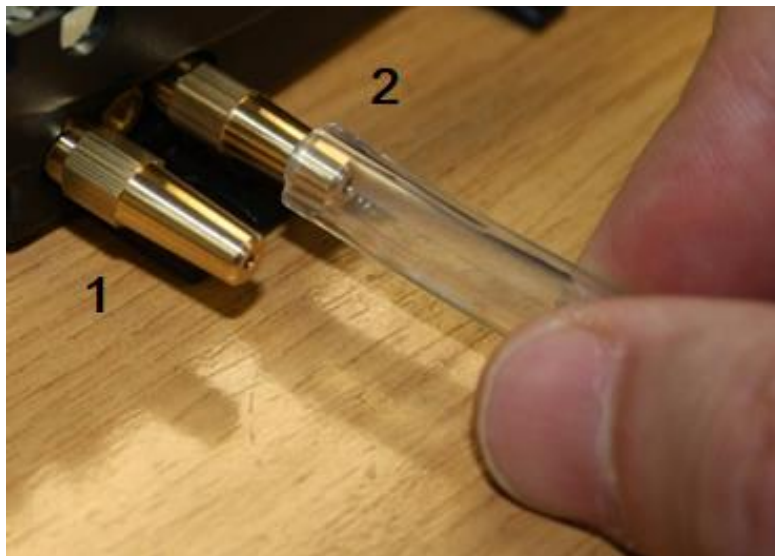

- The Zero and Span times are affected by the length of pipe between the gas source and the Calibration Dock. For best results, ION Science recommends that pipe lengths should be kept to a minimum; the shorter the length, the less gas is needed.



- The table below assumes the use of 5mm ID Tygon pipe.

Pipe length	Zero Time (sec)	Span Time (sec)
100mm	10	22
200mm	12	24
300mm	14	26
400mm	16	28
500mm	18	30
600mm	20	32

- Minimum gas concentration is 2 ppm. Demand flow regulators must be used to supply gas to the Calibration Dock. They must be able to supply 0.3 liters per minute (300 ml/min). The Dock draws as much gas as it needs from the regulator (around 200 ml/min).



- On the [Cubs page](#), click this button for the Cub being calibrated:

- The calibration procedure is then initiated. The Calibration Dock then pumps Zero gas and then Span gas to the sensor. If the calibration is successful, a date/time stamp will appear in the **Calibration** column. Readings will appear in green.
- If calibration fails, readings will appear in red and a message will be displayed giving the reason for the failure:
  - Invalid:** when the Cub is initially connected to the Docking Station this message will appear to advise the user that the Cub does not have a valid calibration. This error also appears if a communication error occurs during calibration.
  - Span too low:** the span gas concentration is not sufficient.
  - Zero too high** the zero reading is too high, such as when drawing in dirty air.
  - Lamp fail:** the lamp failed to strike.
- If a calibration is invalid, the Cub will revert to the previous calibration.

### Remote Calibration

The following equipment is required.

- A clean ambient air supply or a bottle of compressed synthetic air fitted with a 0.3 liter per minute flow regulator (1).
- A bottle of compressed Span gas fitted with a 0.3 liter per minute flow regulator (1).
- Remote calibration adaptor (3).
- Suitable pipe (Tygon) to connect gases to the remote calibration adaptor (2).

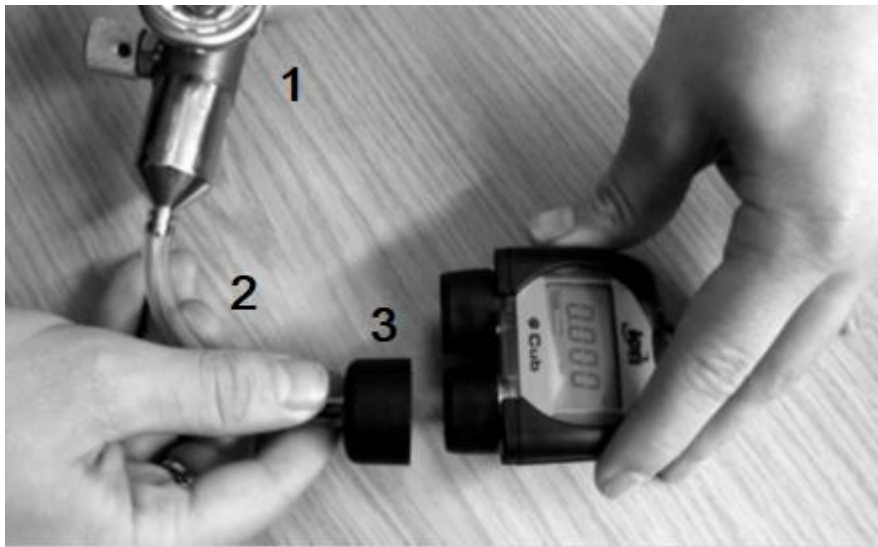

**Important note:** The use of Silicon pipe should be avoided as VOC gases can permeate the walls of the pipe.

### Remote Calibration Procedure

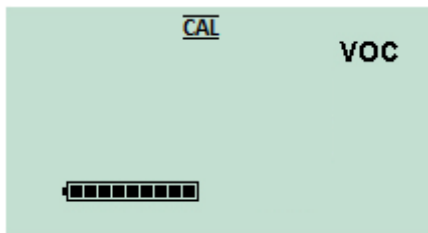

Access the Cub's [remote calibration screen](#).

Press and hold the multi-function button until the Cub beeps then release it quickly to avoid switching it off.

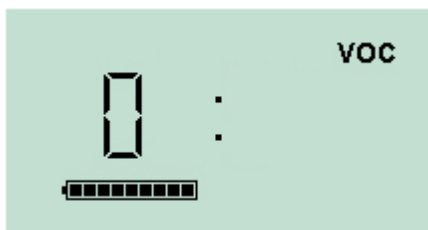

This initiates the Zero stage of the procedure. The screen will display a '0'.

Connect a clean ambient air supply or a bottle of compressed synthetic air.

Switch on the gas supply and then press the multi-function button.



The screen will change and display a live reading from the sensor. *This number does not relate to gas concentration, it simply indicates if the sensor output is changing.*

The reading should decrease. Once it stops changing, press the multi-function button to accept that level. The screen will flash briefly.

Switch off the synthetic/clean air and disconnect it.



Press the multi-function button to initiate the Span stage. The screen will display an 'S'.

Connect the Span gas supply. Switch on the gas supply and press the multi-function button.



The screen will change and display a live reading from the sensor. *This number does not relate to gas concentration, it simply indicates if the sensor output is changing.*

The reading should increase. Once it stops changing, press the multi-function button to accept that level. The screen will flash briefly.

Switch off the Span gas and disconnect it.

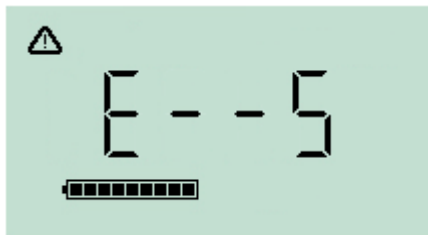

If there is no significant difference between the Zero and Span levels the calibration will be invalid and **E - 5** will be displayed. If this occurs, the previous valid calibration levels will be used.

At the end of the calibration sequence the Cub will revert to the general VOC / normal running.



**Important note:** Always check the calibration in normal running before use by carrying out a bump test. Apply the same Zero and SPAN gas used to calibrate and ensure the correct readings are displayed.

## 8. Maintenance

### Firmware and Software Updates

Refer to [Upgrading Firmware and Software](#).

### Filter Replacement

The Filter Disc should be changed after every 100 hours of use, or sooner for particularly dusty or moisture laden environments. To avoid contaminating Filter Discs, they should only be replaced in a clean environment, using clean hands and equipment.

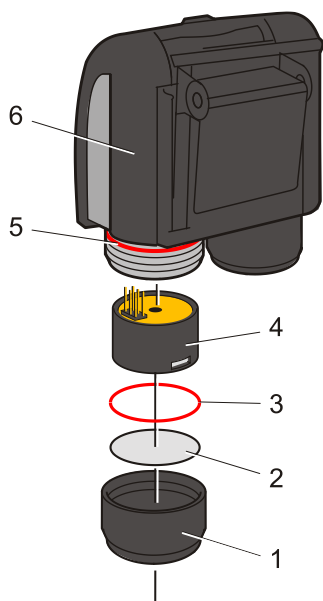

Hold the Cub upright as shown opposite.

To change the Filter Disc (2), unscrew the Sensor Cover (1), and use gloved hands to remove the O Ring (3) and Filter Disc (2).

Carefully place a new Filter Disc (2) and then a new O Ring (3) into the Sensor Cover.

*Under no circumstances should a Filter Disc or O Ring be used once it has been removed.*

Make sure that the upper O Ring (5) has remained in position.

Then ensuring, the Filter Disc (2) and O Ring (3) are correctly positioned, screw the Sensor Cover (1) back onto the Instrument Body (6). Do not over-tighten.



With the Filter Disc, Filter Disc O Ring and upper O Ring correctly fitted the Cub has an IP rating of IP65.  
With the Filter Disc and O Rings removed, the IP rating drops to IP64.

### Water Ingress

If the portable Cub has been immersed or splashed with water, take the MiniPID 2 Sensor out to dry and replace the Filter Disc as described previously.

### Lamp Cleaning and Electrode Stack Replacement



**The Cub is a sensitive detector. Internal components must be handled with clean hands and clean tools. The Cub Lamp is fragile. Handle with great care. Never touch the window and do not drop.**

#### When to Clean or Replace the Lamp

The Cub PID uses an ultraviolet light source ionizing VOC gases as they pass across the lamp window. This process may result in a fine layer of contamination on the detector window that must be removed on a regular basis.

- In normal use the lamp should be cleaned after every 100 hours (based on 30 ppm for 100 hours). If the Cub is used in heavily gas contaminated environments, the lamp should be cleaned more often.
- Please note that some esters, amines and halogenated compounds may accelerate window fouling; in these cases cleaning may be required after every 20 hours of use.
- Cleaning frequency will also depend upon alarm levels set and prevailing environmental conditions.
- Damaged lamps must be replaced immediately. Do not use a Cub with a damaged lamp.

### When to Replace the Electrode Stack

When using your Cub in conditions of high ambient humidity, it may show unexpected and increasing readings. This is due to dust or other small particles within the detector becoming hydrated which causes these particles to conduct a signal between the electrodes.

The problem can be resolved by replacing the electrode stack.

### Removing the MiniPID Sensor

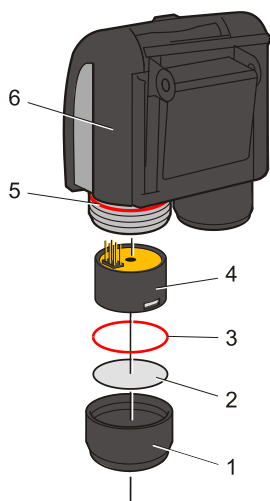

Before lamp cleaning or replacement, the the MiniPID Sensor must be removed.

First ensure that the Cub is turned off and that you are in a clean environment so that the sensor parts will not be contaminated by dust, oil or grease.

Remove the Sensor Cover (1). It can be unscrewed using your fingers.

Carefully lift/pull the MiniPID 2 Sensor Body (4) from the Instrument Body (6).



Using the Mini PID Electrode Stack Removal Tool provided, locate its 'prongs' in the slots in the side of the Mini PID 2 Sensor Body.

Using the forefinger to restrain the white Electrode Stack (the internal parts of the Sensor are spring-loaded), squeeze the Tool to release the Electrode Stack.

### Replacing the MiniPID Electrode Stack

At this point the MiniPID Electrode Stack can be replaced.

Discard the removed (old) Electrode Stack, carefully removing the Lamp if still attached.

Visually check the condition of the Lamp detection window (the upper flat surface of the Lamp). If this needs cleaning, proceed as detailed later.

Place the Electrode Stack onto a clean, flat surface, flat surface downwards. Carefully twist the detection window end of the Lamp into the O ring around the well in the underside of the Electrode Stack. The Lamp window should now sit flush within the Electrode Stack.



This procedure ensures that the Lamp is firmly held in the Electrode Stack with the detection window level with the electrodes for consistent and reliable VOC readings. Lamp placement by any other means is likely to give unreliable readings because the O ring in the Electrode Stack becomes trapped between the window face and the Electrode Stack.

Carefully align the Sensor Body over the Electrode Stack plus Lamp. Push the Sensor Body down to secure the assembly - two clicks should be heard.

Carefully align/push the new MiniPID 2 Sensor Body (4) into the Instrument Body (6).

Then ensuring, the Filter Disc (2) and O Ring (3) are correctly positioned, screw the Sensor Cover (1) back onto the Instrument Body (6). Do not over-tighten.

The instrument MUST now be re-calibrated.

### Lamp Removal and Examination



**The Cub is a sensitive detector. Internal components must be handled with clean hands and clean tools. The Cub Lamp is fragile. Handle with great care. Never touch the window and do not drop.**

Following removal of the Electrode Stack as described previously, the Lamp may now be carefully removed:

- If the Lamp is held in the Electrode Stack, carefully pull it out of the O ring around the well in the underside of the Electrode Stack.
- If the Lamp is sitting in the Sensor Body - the Lamp can be gripped and lifted out or the Sensor Body can be inverted and the Lamp tipped out.

Inspection of the Lamp may reveal a layer of contamination on the detection window. This appears as a 'blue hue.' To check for this, hold the Lamp in front of a light source and look across the window surface at an angle.

If necessary, clean the Lamp.

### Lamp Cleaning

Clean the window using the PID Lamp Cleaning Kit supplied. The Cub 10.6 eV and Cub TAC are provided with a PID lamp cleaning kit, which should be used to clean the lamp window.



**THE CLEANING COMPOUND CONTAINS ALUMINIUM OXIDE AS A VERY FINE POWER. THIS MAY CAUSE IRRITATION OF RESPIRATORY TRACT AND EYES. (CAS Number 1344-28-1).**

A full material safety data sheet MSDS is available on request from ION Science Inc.. The key issues are listed below.

**Handling:**

- Do not breathe vapor/dust. Avoid contact with skin, eyes and clothing.
- Wear suitable protective clothing.
- Follow industrial hygiene practices: Wash face and hands thoroughly with soap and water after use and before eating, drinking, smoking or applying cosmetics.
- The Compound has a TVL (TWA) of 10 mg/m<sup>3</sup>.

**Storage:**

- Always replace the lid after using the cleaning compound.
- Keep container closed to prevent water adsorption and contamination.

**Cub 11.7 eV Lamp:**

To clean the Cub 11.7 eV lamp, please use anhydrous ethanol or methanol. Contact [technical.support@ionscience.com](mailto:technical.support@ionscience.com) for further support.

The cleaning procedure is as follows:

1. Open the vial of Aluminium Oxide polishing compound. With a clean cotton bud collect a small amount of compound.
2. Use this cotton bud to polish the Lamp detection window. Use a circular action applying light pressure to clean the detection window. Never touch the detection window with fingers.



3. Continue polishing until an audible “squeaking” is made by the cotton bud with compound moving over the window surface (usually within fifteen seconds).
4. Remove the residual powder with a short blast of air from the can of clean, dry, oil free air.
5. Refit the Lamp into the Electrode Stack as described previously.

## Replacing a Lamp



**Never refit a damaged Lamp.**



**The instrument MUST be re-calibrated after fitting a replacement or cleaned Lamp.**

Following removal of the Electrode Stack as described previously, the Lamp may be replaced.

Carefully remove the Lamp:

- If the Lamp is held in the Electrode Stack, carefully pull it out of the O ring around the well in the underside of the Electrode Stack.
- If the Lamp is sitting in the Sensor Body - the Lamp can be gripped and lifted out or the Sensor Body can be inverted and the Lamp tipped out.

Discard the removed (old) Lamp.

Place the Electrode Stack onto a clean, flat surface, flat surface downwards. Carefully twist the detection window end of a new Lamp into the O ring around the well in the underside of the Electrode Stack. The Lamp window should now sit flush within the Electrode Stack.



This procedure ensures that the Lamp is firmly held in the Electrode Stack with the detection window, level with the electrodes for consistent and reliable VOC readings. Lamp placement by any other means is likely to give unreliable readings because the O ring in the Electrode Stack becomes trapped between the window face and the Electrode Stack.

Carefully align the Sensor Body over the Electrode Stack plus Lamp. Push the Sensor Body down to secure the assembly - two clicks should be heard.

Carefully align/push the new MiniPID 2 Sensor Body (4) into the Instrument Body (6).

Then ensuring, the Filter Disc (2) and O Ring (3) are correctly positioned, screw the Sensor Cover (1) back onto the Instrument Body (6). Do not over-tighten.

The instrument MUST now be re-calibrated.

## Bump Testing

Bump tests should regularly be carried out on your Cub to test that the instrument responds correctly and that the alarm indicators are triggered correctly when gas is detected at the [alarm levels specified in the Cub's configuration](#). Bump tests should also be carried out when these specified alarm levels are changed.

The **Bump Test** checkboxes (in the **Bump Test** box on the CubPC [Preferences page](#)) is used to specify the gas to be used during the bump test; the options are PID Gas and Calibration Gas.



The bump test procedure follows a similar procedure to that for calibration ( see [Calibration procedure using a Cub Doc](#)), except that the procedure is initiated by pressing the following button on the [Cubs page](#) for the Cub being calibrated:



## 9. Troubleshooting

### Diagnostics

Error Code	Description	Resolution
<b>1</b>	Sensor configuration error	Contact distributor
<b>2</b>	Flash memory error	Contact distributor
<b>3</b>	i2c bus error	Contact distributor
<b>4</b>	i2c bus to fuel gauge error	Contact distributor
<b>5</b>	Calibration fail	<ol style="list-style-type: none"> <li>1. Check calibration setup</li> <li>2. Check calibration gas connection to the calibration dock</li> <li>3. Contact distributor</li> </ol>
<b>6</b>	Sensor power	Contact distributor
<b>7</b>	Lamp strike fail	<ol style="list-style-type: none"> <li>1. Replace electrode stack</li> <li>2. Replace lamp</li> <li>3. Contact distributor</li> </ol>
<b>8</b>	i2c ADC error	Contact distributor
<b>9</b>	ADC range error	Contact distributor
<b>11</b>	Internal temperature of the cub is too high	The Cub will stop charging until the temperature is less than 45°C. Leave device to cool in the dock, or move to a cooler ambient environment
<b>A</b>	PID sensor connection issue	<ol style="list-style-type: none"> <li>1. Try fitting a known working Mini PID</li> <li>2. Contact distributor</li> </ol>

## 10. Appendix and Supporting Documents

### EU Declaration of Conformity

The EU Authorised Representative of the manufacturer Ion Science limited has sole responsibility, on the date this product accompanied by this declaration is placed on the market, the product conforms to all technical and regulatory requirements of the listed directives

**Authorised Representative:** ISM Deutschland GmbH · Laubach 30 · D-40822 Mettmann, Germany

**Product:** Cub

**Product description:** Intrinsically safe photo-ionisation gas detector for detecting volatile organic compounds

**Directive:** ATEX Directive (2014/34/EU)  
EMC Directive (2014/30/EU)

**Type of protection:**  II 1 G Ex ia IIC T4 Ga (-20oC ≤ Ta ≤ +55oC)

**Certificate Number:** Baseefa11ATEX0027 IECEx BAS 11.0014

**Notified body:** SGS Fimko 0598

**Certificate:** Baseefa11ATEX0027

**North American certifying authority:** SGS

**North American File #:** HAZLOC :- SGSNA/19/BAS/00001  
ORDLOC:- SGSNA?18/SUW/00187

**Standards:**

**EN ISO 60079-0:2018** Electrical apparatus for explosive gas atmospheres. General requirements

**EN ISO 60079-11:2012** Explosive atmospheres. Equipment protection by intrinsic safety “I”

**EN ISO 61326-1:2013** Electrical equipment for measurement, control and laboratory use – EMC requirements. Group 1, Class B equipment – (emissions section only)

**EN ISO 61326-1:2013** Electrical equipment for measurement, control and laboratory use – EMC requirements. Industrial location immunity – (immunity section only)

**EN 50270:2015** Electromagnetic compatibility – Electrical apparatus for the detection and measurement of combustible gases, toxic gases or oxygen. Immunity Type 2 – industrial environments.

**EN ISO 61010-1:2010** Safety requirements for measurement, control & lab equipment

**EN ISO/IEC 9001:2015** Quality Management System – Requirements

**EN ISO/IEC 80079-34 :2011** Potentially Explosive Atmospheres – Application of Quality Systems

**Name:** Clemens A. Verley

**Position:** Chief Executive Officer



**Signature:**

**Date:** 31<sup>st</sup> December 2020

## Technical Specifications

### Cub Specifications

**Response time:** T90 < 13 seconds <sup>2</sup>

**Detectable ranges:**

**ppm:** 0 to 5,000 ppm (0.1 ppm sensitivity) <sup>2 4 5</sup>

**ppb:** 0 to 5,000 ppm (0.001 ppm sensitivity) <sup>2 4 5</sup>

**TAC:** 0 to 5,000 ppm (0.01 ppm sensitivity) <sup>2 4 5</sup>

**Resolution:** Depends on the model (see Detection range, above.)

**Accuracy:** +/- 5% displayed reading +/- one digit <sup>2 4</sup>

**Linearity:** +/- 5% displayed reading +/- one digit <sup>2 4</sup>

**Battery:** Lithium ion, 12 hours

**Data log:** Including date / time: 30,000

**Alarm visual:** Flashing Red and Amber LED

**Alarm audible:** 95 dB @ 300 mm

**Flow Rate:** Not applicable (no pump)

**Temperature:**

**Operating:** -20 to 60 °C (-4 to 140 °F)

**Storage:** -25 to 60 °C (-13 to 140 °F)

**Certified to:** -20 to 55°C (-4 to 131°F)

**Dimensions (Instrument):** 61mm x 66mm x 59mm (2.4" x 2.6" x 2.3")

**Weight (Instrument):** 111g (3.9 oz)

**Ingress protection:**

**with PTFE filter fitted:** IP65 <sup>1</sup>

### Cub 11.7 eV Specification

<b>Response time:</b>	T90 < 13 seconds <sup>2</sup>
<b>Detectable ranges:</b>	
<b>Cub 11.7 eV:</b>	0 to 5,000 ppm (0.5 ppm sensitivity) <sup>2 4 5</sup>
<b>Resolution:</b>	Depends on the model (see Detection range, above.)
<b>Accuracy:</b>	+/- 12% of displayed reading <sup>2 4</sup>
<b>Battery</b>	Battery life up to 12 hours Battery charge time 4 hours
<b>Alarm visual:</b>	Flashing Red and Amber LED
<b>Alarm audible:</b>	95 dB @ 300 mm
<b>Flow Rate:</b>	Not applicable (no pump)
<b>Temperature:</b>	
<b>Operating:</b>	0°C to 55°C
<b>Storage:</b>	0°C to 55°C
<b>Certified to:</b>	0°C to 55°C
<b>Dimensions (Instrument):</b>	61mm x 66mm x 59mm (2.4" x 2.6" x 2.3")
<b>Weight (Instrument):</b>	111g (3.9 oz)
<b>Ingress protection:</b>	
<b>with PTFE filter fitted:</b>	IP65 <sup>1</sup>

<sup>1</sup> IP65 with PTFE filter fitted, IP64 without PTFE filter fitted.

<sup>2</sup> Specifications are based on isobutylene calibrations at 20 °C and 1000mBar. All specifications quoted are at calibration point and under the same ambient conditions.

<sup>4</sup> For indicative measurement only. Quoted accuracy achievable up to 2,000 ppm. For more accurate detection, calibration around concentration of interest is recommended.

<sup>5</sup> Maximum reading is achieved with certain analytes.

### Cub Doc Power Supply Requirements

Power supply requirement for Cub Doc Docking Stations is as follows:

- Through the IEC mains plug limited to a nominal of 100Vac to 240Vac +/-10% input range. The inlet fuse is Mains ceramic 1A time lag (anti-surge 20 x 5mm cartridge).

or:

- Through the rear DC socket connected to a 12V car auxiliary/ (cigarette lighter) outlet.

### Warranty

Standard Warranty can be extended to up to 2 years on the Cub when registering your instrument via our website: [www.ionscience.com/usa](http://www.ionscience.com/usa)

To receive your Extended Warranty, you need to register within one month of purchase (Terms and Conditions apply). You will then receive a confirmation email that your Extended Warranty Period has been activated and processed.

The 11.7 eV lamp has a lifetime of  $\geq 500$  hours. This is based on continuous use.

Full details, along with a copy of our Warranty Statement can be found by visiting: [www.ionscience.com/usa](http://www.ionscience.com/usa)

## ION Science Contact Details

### UK and Head Office

ION Science Ltd  
The Way, Fowlmere  
Cambridge  
SG8 7UJ  
UK

Tel: +44 (0)1763 208503

Fax: +44 (0) 1763 208814

Web: [www.ionscience.com](http://www.ionscience.com)

Email: [info@ionscience.com](mailto:info@ionscience.com)

### German Office

ISM ION Science Messtechnik  
Laubach 30  
Metmann-Neandertal  
D-40822  
GERMANY

Tel: +49 2104 14480

Fax: +49 2104 144825

Web: [www.ism-d.de](http://www.ism-d.de)

Email: [info@ism-d.de](mailto:info@ism-d.de)

### French Office

ION Science France  
41 Rue de Etoiles,  
83240 Cavalaire-sur-Mer,  
FRANCE

Tel: +33 6 13 50 55 35

Web: [www.ionscience.com/fr](http://www.ionscience.com/fr)

Email: [info@ionscience.fr](mailto:info@ionscience.fr)

### India Office

ION Science India  
#1-90/B/B/3/1, Charmy  
Vittal Rao Nagar  
Image Hospital Lane, Madhapur,  
Hyderabad – 500 081

Telangana State - India

Tel: +91 40 4853 6129

Web: [www.ionscience.com/in](http://www.ionscience.com/in)

### USA Office

ION Science Inc  
4153 Bluebonnet Drive  
Stafford  
TX 77477  
USA

Tel: +1 877 864 7710

Web: [www.ionscience.com/usa](http://www.ionscience.com/usa)

Email: [info@ionscienceusa.com](mailto:info@ionscienceusa.com)

### Italian Office

ION Science Italia  
Via Emilia 51/c  
40011 Anzola Emilia  
Bologna  
ITALY

Tel: +39 051 0561850

Fax: +39 051 0561851

Web: [www.ionscience.com/it](http://www.ionscience.com/it)

Email: [info@ionscience.it](mailto:info@ionscience.it)

### Chinese Office

ION Science China Ltd  
1101 Bldg B, Far East International Plaza  
No. 317,  
Xianxia Road, Shanghai  
P.R. CHINA

Tel: +86 21 52545988

Fax: +86 21 52545986

Web: [www.ionscience.com/cn](http://www.ionscience.com/cn)

Email: [info@ionscience.cn](mailto:info@ionscience.cn)

Manual Log

Manual version	Amendment	Issue date	Instrument firmware	PC software
2.0	Specification updated Page 40 MiniPID 2 2 spring part number updated Page 37. MiniPID 2	19/4/2016	n/a	n/a
2.2	Warranty statement – Page 2 Cub materials exposure updated – Page 3 Declaration of conformity – Page 4 Turning on the Cub – Page 11 Added section: Actions on dock. Page 22 Updated sound section. Page 24 Part descriptions updated – Page p.35, 37, 38 Specification – Page 40 Disclaimer added – Page 41	14/02/2017	0.0.77	0.0.0.41
2.2R	Logo only	31/07/2017	0.0.77	0.0.0.41
2.3	Images on page: 0, 19, 20, 21, 25, 30 Text on page: 3, 4, 6, 8, 10, 11, 15, 16, 18, 19, 23, 24, 25, 26, 27, 29, 30, 35, 37, 39, 42, 43, 44, 45, 46	21/02/2018	0.0.80	0.0.0.45
2.4	<ul style="list-style-type: none"> <li>Added functionality that the Cub only logs when an alarm level is triggered. Requires Cub firmware version 0.0.88 or later.</li> <li>Archive Cubs from CubPC list.</li> <li>Extracted csv for concentration-exceeded data logs collated into single session.</li> <li>Extracted csv for concentration-exceeded data logs to display how many times trigger value is exceeded.</li> </ul>	24/09/2019	0.0.88	0.0.0.53



	<ul style="list-style-type: none"><li>Added new error code E-11, when Cub stops charging if internal temperature exceeds 45°C</li></ul>			
2.4R	Declaration of conformity updated	31/12/2020	0.0.88	0.0.0.53
2.5	Cub 11.7 eV added.	25/03/2021	0.0.88	0.0.0.53