



Aqua TROLL 500

Operator's Manual



For Sales & Service Contact

geotech

2650 E. 40th Ave. • Denver, CO 80205
Phone 303-320-4764 • Fax 303-322-7242

1-800-833-7958

www.geotechenv.com

Information subject to change without notice. In-Situ, In-Situ logo, "Water Simplified", VuLink, RDO, RuggedCable, TROLL, BaroTROLL, HydroVu, VuSitu, Baro Merge, and Win-Situ are trademarks or registered trademarks of In-Situ Inc. ©2023. All rights reserved. This product may be covered by patents identified at www.in-situ.com/patents



For a list of local compliance representatives, see <https://in-situ.com/us/faq/regulatory-compliance/compliance-information/global-market-contacts>

Contents

Introduction	7
Serial Number Location	7
Instrument Description.....	7
Document Conventions	7
Unpacking and Inspecting	7
Safety	8
Intended Use	8
Instrument Specifications	9
External Power Source Requirements	9
Instrument Dimensions	10
Instrument Components	11
End View	11
Sensor Port	11
Detail	11
Exploded View 1	11
Exploded View 2	11
Sensor Specifications	12
Sensor Summary	12
Solutions	13
Potential Interferents.....	14
RDO Cap Chemical Incompatibility	14
Conductivity/Temperature Sensor	14
Ammonium, Chloride, and Nitrate Interferent Concentrations	15
Fluorometer Wavelengths	16
Additional Information	16
Required Accessories	17
Communication Device	17
Telemetry + Communication Device	17
Software	17
Wireless TROLL Com.....	17
Cable.....	18
Sensors.....	18
Rugged Twist-Lock Cable	18
System Components	19
Spot Checking Configuration	23

Wireless TROLL Com.....	23
Rugged Cable	23
Aqua TROLL 500	23
Getting Started (Spot-Checking)	24
Parameters and Sensors	29
Using the RDO Sensor and Sensor Cap.....	29
Handling pH and Ion-Selective Electrode Sensors	29
Using Ion-Selective Electrode Sensors	30
Ammonium Sensor Requirements	30
Chloride, Nitrate, and pH/ORP Sensor Requirements.....	30
Derived Parameters.....	31
LCD Screen	32
Accessing the LCD Menu.....	32
Possible Port Statuses.....	32
Possible Power Statuses.....	32
Possible Connected Statuses.....	32
Error Messages	32
Calibrating Sensors	34
Solution-Based Calibration	34
Turbidity Sensor Calibration	34
Fluorometer Calibration	34
RDO 100% Saturation Calibration: Water Saturated Air.....	35
RDO 100% Saturation Calibration: Saturation Bubbler	35
RDO Salinity Setting.....	36
Reported Depth.....	37
Calibration Frequency Recommendations	38
Batch Calibrating Sensors in VuSitu.....	40
Different Sensor Types (Quick Cal Solution)	40
Multiple Sensors of the Same Type	41
Navigating VuSitu.....	42
VuSitu Mobile App.....	42
Connected Instrument Screen	42
VuSitu Menu Options	43
Selecting with Long-press and Swipe	43
Live Readings in VuSitu.....	44
Snapshot Mode.....	44
Live Readings Mode.....	44
VuSitu Data	45

Sharing Data	45
Viewing Data on a Mac or PC.....	45
VuSitu Locations	46
About VuSitu Locations	46
How to Create a Location.....	46
How to Edit or Delete a Location.....	46
How to Select a Location.....	47
Remote-Monitoring Configuration (Telemetry)	48
HydroVu	50
Connecting to Win-Situ on a PC.....	51
Connecting to Win-Situ via USB.....	51
Navigating the Win-Situ Interface.....	52
Home Tab	52
Sensor Tab.....	52
Device Setup Tab.....	53
Connecting the Aqua TROLL 500 to a PLC or Data Logger	54
Flying Leads Wire Diagram	54
Configuring SDI-12 Settings	58
About SDI-12	58
Configure SDI-12 Settings in VuSitu	58
Modbus PLC Interface	58
Overview	58
Setting Up Instrument	59
Programming the PLC	59
Reading Device Information	59
Reading Parameters	60
Care and Maintenance	61
Storage.....	61
Cleaning the Sonde.....	61
Removing the Restrictor.....	61
Maintenance Schedule	62
User-Serviceable Parts.....	62
Wiper Maintenance	62
Cleaning and Storing the pH/ORP Sensor and Ion-Selective Electrode (ISE) sensors.....	63
Cleaning and Storing the RDO Sensor	65
Cleaning and Storing the Turbidity Sensor.....	65
Cleaning and Storing the Conductivity Sensor.....	66
Cleaning the Copper Antifouling Restrictor.....	66

Service and Repair	67
Obtaining Repair Service.....	67
Guidelines for Cleaning Returned Equipment	68
More Information	69
Appendix	72
Appendix A: Parameter Numbers and Locations	72
Appendix B: Unit IDs	75

Introduction

Serial Number Location

The instrument serial number is on the product label affixed to the instrument body. Serial numbers for individual sensors are engraved on the sensor body.

Instrument Description

The Aqua TROLL 500 uses the latest sensor and electronics technology to provide laboratory-quality measurements for field use. Parameters include water level, pH, dissolved oxygen, and more. The instrument fits inside wells as small as 2" in diameter. An optional water level/pressure sensor and a barometric pressure sensor are integrated into the sonde. Additional sensors may be selected and replaced to suit your project's needs. An optional motorized sensor wiper may also be included on the instrument.

Use the Aqua TROLL 500 for long-term monitoring in freshwater and marine environments. It's also ideal for the following applications:

- Groundwater sampling
- Low-flow testing
- Mine water monitoring
- Stormwater management

The built-in LCD screen displays battery status, connectivity info, and other vital information. Setup is easy with the VuSitu app and a Bluetooth-enabled mobile device. The Aqua TROLL 500 works with external PLCs and works with telemetry devices for remote monitoring.

Document Conventions

Throughout this document you will see the following symbols:



A checkmark highlights a tip or feature.



The exclamation point calls your attention to a requirement, safety issue, or important action that should not be overlooked.

Unpacking and Inspecting

Your equipment was carefully inspected before shipping. Check the equipment for any physical damage sustained during shipment. Notify In-Situ and file a claim with the carrier if there is any such damage; do not attempt to deploy or operate the instrument.



Save packing materials for future storage and shipping of your equipment.

Accessories may be shipped separately and should be inspected for physical damage and order fulfillment.

Safety



Read the safety information on this page before deploying or configuring your Aqua TROLL 500. If you have questions, contact In-Situ Technical Support for assistance.

- Do not use the Aqua TROLL 500 in any manner not specified by the manufacturer.
- Do not submerge the Wireless TROLL Com or your mobile device in liquid.
- Do not submerge the Twist-Lock connector ends of the cable or instrument when they are not connected.
- Ensure that sensors, or sensor plugs, are completely inserted into the ports, so that no liquid can enter the instrument.
- Ensure that the RDO Sensor Cap is pressed firmly over the sensor lens and is flush with the instrument before submerging in liquid.
- Replace the cable if insulation or connectors are damaged.
- Make sure the probe and sensor O-rings are clean and free of damage.

Intended Use

The Aqua TROLL® 500 Multiparameter Sonde is designed to be safe:

- during indoor or outdoor use;
- at altitudes above or below 2000m;
- in ambient temperatures from -5 to 50C;
- in any relative humidity levels;



If the equipment is used in a manner not specified by the manufacturer, the protection provided by the equipment may be impaired.

Instrument Specifications

Operating temperature	-5° to 50° C (23° to 122° F) Nitrate and Ammonium Sensors: 0 to 40° C (32 to 104° F) Chloride Sensors: 0 to 50° C (32 to 122° F)
Storage temperature	Components without fluid: -40° to 65° C (-40° to 149°F) pH/ORP sensors: -5 to 65° C (23 to 149° F) Nitrate and Ammonium Sensors: 0 to 40° C (32 to 104° F) Chloride Sensors: 0 to 50° C (32 to 122° F)
Dimensions	Length: 46 cm (18.145") (includes connector) Diameter: 4.7 cm (1.860") With bail: 59cm (23.25")
Weight	0.978kg / 2.15 lbs. (includes instrument, sensors, restrictor and bumpers)
Wetted materials (sonde and sensors)	Polyphenylsulfone, Polycarbonate, Acetal, EPDM/Polypropylene TPV, FKM Fluoroelastomer, Titanium, Fluorocarbon Coating, Ceramic, Inconel, Acrylic Adhesive Film, Nylon, Polyurethane Adhesive, Graphite, PC/PMMA Blend, Acrylic, Sapphire, PVC, Platinum, Glass
Environmental rating	IP68 with all sensors and cable attached. IP67 with sensors removed or cable detached
Max pressure rating	Up to 150 PSI Ammonium/Nitrate up to 30PSI
Communication	RS485/MODBUS, Wireless TROLL Com, Bluetooth®
Reading rate	1 reading every 2 seconds
LCD screen	Integrated display shows status of sonde, sensor ports, power voltage and connectivity. BlueTooth may be disabled through the hidden menu
External power voltage External power current ¹	8-36 VDC (required for normal operation) Sleep: < 0.2 mA typical Measurement: 40 mA typical, 75 mA Max
Cable	Vented or non-vented polyurethane or vented Tefzel®
Hex screw driver	0.050 in. (1.3 mm)
Software interface	Android/iOS: VuSitu Mobile App (see app store for OS requirements) Windows: Win-Situ 5 Data Services: HydroVu
Certifications	CE, FCC, WEEE, RoHS, UKCA Compliant
Warranty	2 year - sonde, sensors (excluding ISE sensors) 1 year - Nitrate, Chloride, and Ammonium Sensors Other - see warranty policy at www.in-situ.com

External Power Source Requirements



Current from an external power source must not exceed 4 amps.

Instrument Dimensions



Instrument Components

Exploded View 1

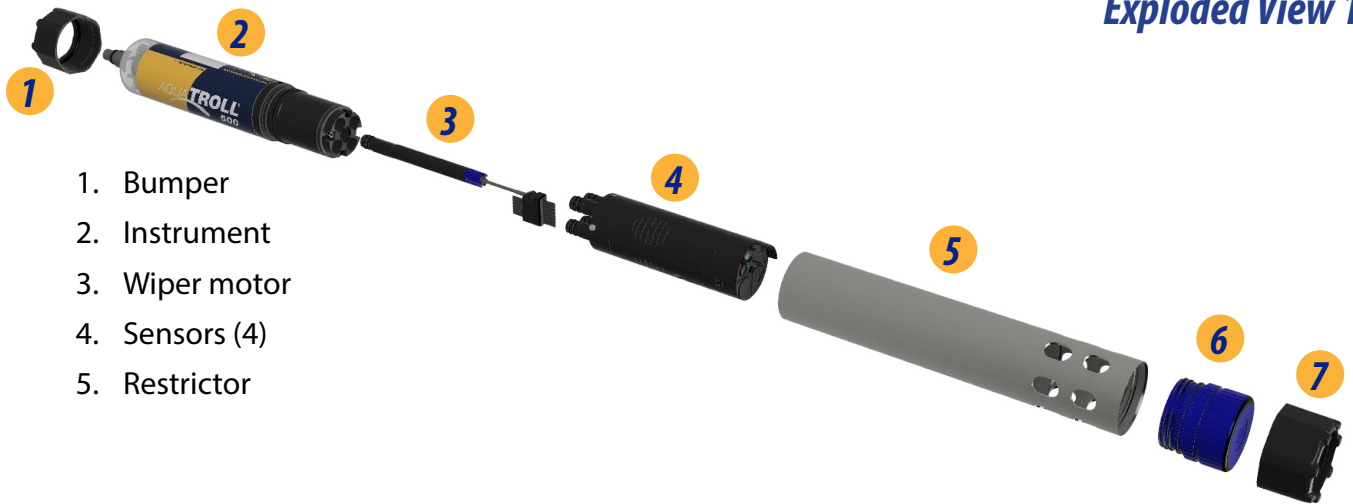

1. Bumper
2. Instrument
3. Wiper motor
4. Sensors (4)
5. Restrictor

Exploded View 2



6. End Cap
7. Bumper
8. Bulkhead connector

End View

Flat edge of connector aligns with flat edge of Rugged Cable.



Sensor Port Detail

Sensor ports

Wiper motor port

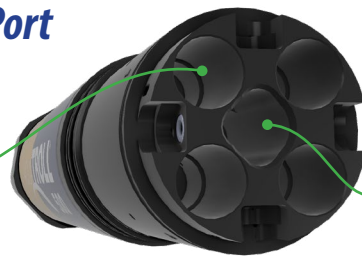

Sensor Specifications

Sensor Summary

Sensors	Expected Lifetime*	Recommended Calibration Frequency	Pressure Rating - PSI	Usable Depth m ft		Operational Temperature Range
pH/ORP	2 years or greater**	10 to 12 weeks**	350	250	820	- 5 to 50° C
RDO	2 years or greater	12 months**	350	250	820	- 5 to 50° C
Conductivity	2 years or greater	User calibration only if needed	350	250	820	- 5 to 50° C
Temperature	2 years or greater	NA	350	250	820	- 5 to 50° C
Turbidity	2 years or greater	User calibration only if needed	350	250	820	- 5 to 50° C
Pressure	2 years or greater	User calibration only if needed	12.8 14.2 42.7 108 142 285 350	9 10 30 76 100 200 250	30 33 100 250 328 650 820	- 5 to 50° C
Barometric Pressure	2 years or greater	User calibration only if needed	NA	NA	NA	- 5 to 50° C
Ammonium	6 to 12 months**	Monthly**	30	25	70	0 to 40° C
Chloride	1 year or greater**	Monthly**	350	250	820	0 to 50° C
Nitrate	6 to 12 months**	Monthly**	30	25	70	0 to 40° C
Chlorophyll a	2 years or greater	User calibration only if needed	350	250	820	- 5 to 50° C
BGA-PC	2 years or greater	User calibration only if needed	350	250	820	- 5 to 50° C
BGA-PE	2 years or greater	User calibration only if needed	350	250	820	- 5 to 50° C
Rhodamine	2 years or greater	User calibration only if needed	350	250	820	- 5 to 50° C
Fluorescein	2 years or greater	User calibration only if needed	350	250	820	- 5 to 50° C
FDOM	2 years or greater	User calibration only if needed	350	250	820	- 5 to 50° C
Crude Oil	2 years or greater	User calibration only if needed	350	250	820	- 5 to 50° C

* Expected lifetime includes total shelf life and deployment lifetime.

** Lifetime and calibration frequency depend on site and storage conditions.

Solutions

Solution	Shelf Life - Unopened	Shelf Life - Opened
Quick Cal	4 months. Store in a cool, dark place. Shake before use.	7 to 21 days (± 10 mV, ± 0.05 pH, ± 50 $\mu\text{S}/\text{cm}$)
ZoBell's	9 months. Store in a cool, dark place.	3 to 6 months
Low Conductivity (147 $\mu\text{S}/\text{cm}$)	12 months	Hours (± 1 $\mu\text{S}/\text{cm}$, check before use)
Other Conductivity	12 months	3 to 6 months
pH Calibration Buffers	24 months	3 to 6 months
Sensor Reference Filling Solution	24 months	12 months
pH Storage Solution	24 months	12 months
Sodium Sulfite	12 months	3 to 6 months
Turbidity	12 months	12 months from expiration date
Deionized Water	24 months	Hours, check before use for calibration
Ammonium	12 months	3 to 6 months
Chloride	12 months	3 to 6 months
Nitrate	12 months	3 to 6 months

Potential Interferents

pH

Sodium salts (at pH >12)

Dissolved Oxygen

Temperature, atmospheric pressure, salinity, chlorinity

Ammonium

Cesium, Potassium, Thallium, pH, Silver, Lithium, Sodium

Nitrate

Perchlorate, Iodide, Chlorate, Cyanide, Bromide, Nitrite, Hydrogen Sulfide (bisulfite), Hydrogen Carbonate (bicarbonate), Carbonate, Chloride, Dihydrogen Phosphate, Hydrogen Phosphate, Phosphate, Acetate, Fluoride, Sulfate

Conductivity

Temperature

ORP

Ions that are stronger reducing agents than hydrogen or platinum, e.g., chromium, vanadium, titanium, etc.

Chloride

Hydroxide, Ammonia, Thiosulfate, Bromide, Sulfide, Iodide, Cyanide

BGA-PC, BGA-PE, Chlorophyll a, Rhodamine WT
Turbidity

RDO Cap Chemical Incompatibility



The following chemicals will damage the RDO sensing element.

- Alcohols > 5%
- Hydrogen peroxide > 3%
- Sodium hypochlorite (commercial bleach) > 3%
- Gaseous sulfur dioxide
- Gaseous chlorine
- Do not use in organic solvents (e.g., acetone, chloroform, methylene chloride, etc.), which may destroy the sensing element

Conductivity/Temperature Sensor



Soaking the Conductivity/Temperature sensor in vinegar for longer than one hour can cause serious damage.

Ammonium, Chloride, and Nitrate Interferent Concentrations

Ammonium

The table below lists concentrations of possible interfering ions that cause 10% error at various levels (in ppm) of NH_4^+ .

Ion	100 ppm NH_4^+	10 ppm NH_4^+	1 ppm NH_4^+
Cesium (Cs^+)	100	10	1
Potassium (K^+)	270	27	2.7
Thallium (Tl^+)	3100	310	31
pH (H^+)	pH 1.6	pH 2.6	pH 3.6
Silver (Ag^+)	270,000	27,000	2,700
Lithium (Li^+)	35,000	3,500	350
Sodium (Na^+)	11,100	1,100	110

Chloride

The table below lists concentrations of possible interfering ions that cause 10% error at various levels (in ppm) of Cl^- .

Ion	100 ppm Cl^-	10 ppm Cl^-	1 ppm Cl^-
Hydroxide (OH^-)	3,840	384	38.4
Ammonia (NH_3)	6	0.6	0.06
Thiosulfate ($\text{S}_2\text{O}_3^{2-}$)	3	0.3	0.03
Bromide (Br^-)	0.68	0.068	6.8×10^{-3}
Sulfide (S^{2-})	9×10^{-5}	9×10^{-6}	9×10^{-7}
Iodide (I^-)	1.8×10^{-4}	1.8×10^{-5}	1.8×10^{-6}
Cyanide (CN^-)	1.5×10^{-5}	1.5×10^{-6}	1.5×10^{-7}

Nitrate

The table below lists concentrations of possible interfering ions that cause 10% error at various levels (in ppm) of NO_3^- .

Ion	100 ppm NO_3^-	10 ppm NO_3^-	1 ppm NO_3^-
Perchlorate (ClO_4^-)	7×10^{-2}	7×10^{-3}	7×10^{-4}
Iodide (I^-)	4	0.4	0.04
Chlorate (ClO_3^-)	30	3	0.3
Cyanide (CN^-)	20	2	0.2
Bromide (Br^-)	400	40	4
Nitrite (NO_2^-)	230	23	2
Hydrogen Sulfide (HS^-)	230	23	2

Bicarbonate (HCO ₃ ⁻)	440	440	44
Carbonate (CO ₃ ²⁻)	8,600	860	86
Chloride (Cl ⁻)	7,600	760	76
Dihydrogen Phosphate (H ₂ PO ₄ ⁻)	34,640	3,464	346
Hydrogen Phosphate (HPO ₄ ²⁻)	34,300	3,430	343
Phosphate (PO ₄ ³⁻)	33,900	3,390	339
Acetate (OAc ⁻)	104,200	10,420	1,042
Fluoride (F ⁻)	81,400	8,140	814
Sulfate (SO ₄ ²⁻)	685,700	68,570	6,857

Fluorometer Wavelengths

Sensor	Excitation Wavelength (nominal)	Detection Wavelength
Chlorophyll a	430 nm	675 nm to 750 nm
BGA-PC	590 nm	640 nm to 690 nm
BGA-PE	498 nm	575 nm to 625 nm
Rhodamine	530 nm	580 nm to 660 nm
Fluorescein	462 nm	525 nm to 570 nm
FDOM	375 nm	455 nm to 530 nm
Crude Oil	365 nm	430 nm to 505 nm

Additional Information

For additional sensor details including accuracy, range, resolution, methodology, detection limits, response time, and more, view the [Aqua TROLL specification sheet at www.in-situ.com](http://www.in-situ.com).

Required Accessories

Communication Device

You will need a communication device to calibrate, configure and deploy the Aqua TROLL 500.



Wireless TROLL Com

Provides power to the Aqua TROLL 500.

Calibrate, configure and deploy with a Bluetooth-enabled Android or iOS device.

Telemetry + Communication Device



VuLink

Provides power to the Aqua TROLL 500 in remote-monitoring applications.

Calibrate, configure and deploy with a Bluetooth-enabled Android or iOS device.

Send data to HydroVu or an external FTP Server

Software



VuSitu Mobile App

Calibrate, configure and deploy the Aqua TROLL 500 from a Bluetooth-enabled Android or iOS device.



Win-Situ 5 Software for PC

Calibrate, configure and take readings with the Aqua TROLL 500 from a PC.

Get it from your device's app store.

Download it from www.in-situ.com.

Cable



Rugged Twist-Lock Cable

Connects the Aqua TROLL 500 to a Wireless TROLL Com or VuLink.

Vented or non-vented.

Stripped and tinned available for connecting to 3rd-party equipment.

Sensors



Available Sensors

1. Temperature
2. Conductivity/temperature
3. pH/ORP
4. RDO
5. Turbidity
6. Ammonium
7. Chloride
8. Nitrate
9. Chlorophyll a Fluorescence
10. BGA-PC Fluorescence
11. BGA-PE Fluorescence
12. Rhodamine WT
13. Fluorescein WT
14. FDOM Fluorescence
15. Crude Oil Fluorescence

System Components

Sensors	
RDO Sensor - includes RDO-X Cap	0063450
RDO Sensor - includes RDO Fast Cap	0038520
Combination pH/ORP Sensor	0063470
Turbidity Sensor	0063480
Combination Conductivity/Temperature Sensor or standalone Temperature Sensor	0063460, 0063490
Ammonium Sensor	0033700
Nitrate Sensor	0033710
Chloride Sensor	0033720
Chlorophyll A Sensor	0038900
Phycocyanin (BGA-PC) Sensor	0038920
Phycocerythrin (BGA-PE) Sensor	0038930
Rhodamine WT Sensor	0038890
Fluorescein WT Sensor	0096050
Crude Oil Sensor	0096060
Fluorescent Dissolved Organic Matter (FDOM) Sensor	0096070
Sensor Port Plugs (2)	0063510
Communications	
Wireless TROLL Com for Android	0031240
Mobile Device for Android	0064860
TROLL Com RS-232 Cable Connect	0056140
TROLL Com USB Cable Connect	0052500
TROLL Com RS-232 Direct Connect	0056150
TROLL Com USB Direct Connect	0052510
Accessories	Part Number
Dual Titanium Restrictor/Storage Chamber	0079820
Rubber Bumpers (2)	0079880
Wiper or Wiper Port Plug	0063500, 0064630

Cable	
Stripped-and-tinned Cable with male connector	0053310
Twist-lock Bulkhead Connector	0053240
Twist-lock Backshell/Hanger, Titanium	0051480
Cable Extender	0051490
Large Desiccant (titanium connector)	0051810
Large Desiccant (ABS connector)	0053550
Small Desiccant (3 pack) - storage desiccant	0052230
Desiccant Refill Kit for Large or Outboard Desiccant	0029140
Calibration and Maintenance	
RDO Classic Cap Replacement Kit	0079790
pH/ORP Replacement Reference Junction Kit	0078990
Wiper Brush Kit	0079810
Maintenance Kit	0078940
Copper Antifouling Guard	0076100
Quick-Cal Solution for calibrating DO, Cond., pH & ORP	0033250
Dissolved Oxygen Calibration Kit	0032110
D.O. Field Calibration Kit	0080830
Conductivity Calibration Kit (Full)	0032090
Conductivity Calibration Kit (Low)	0032630
Conductivity Calibration Kit (High)	0032640
pH Calibration Kit	0032080
pH/ORP Calibration Kit	0032120
pH Storage Solution	0065370
Individual Calibration Solutions	See website
Ammonium Calibration Kit (includes 1 liter each: 14 ppm, 140 ppm, 1400 ppm, DI water)	0032140
Chloride Calibration Kit (includes 1 liter each: 35.5 ppm, 355 ppm, 3545 ppm, DI water)	0032150
Nitrate Calibration Kit (includes 1 liter each: 14 ppm, 140 ppm, 1400 ppm, DI water)	0032130
Fluorescein WT Solid State RFU Calibrator	0104290
FDOM Solid State RFU Calibrator	0104300
Crude Oil Solid State RFU Calibrator	0104310

Low-Flow	
Complete Low-Flow Kit (includes flow cell with fittings and stake, base plate, documentation)	0079790
Flow Cell Kit	0078990
Flow Cell Base Plate	0079810
Fittings Kit	0032130
Pelican Case with Foam Insert	0066860

RuggedCable System

RuggedCable Systems are custom-built, durable, direct-read cables that include the following items:

- Titanium twist-lock connectors for quick, reliable connections to the instrument, desiccant, and communication cable
- Metal shield beneath the cable jacket to prevent electrical interferences
- Kellems grip for secure instrument deployment
- Small desiccant for vented systems (for storage only)

Vented or Non-Vented Cable

Vented cable is used with vented pressure sensors to produce gauged measurements. The cable vent tube ensures that atmospheric pressure is applied to the back of the sensor diaphragm.

Non-vented cable is used with non-vented instruments for absolute measurements. Compensate absolute measurements by using a BaroTROLL Instrument and Win-Situ Baro Merge Software.



Vented cable is shipped with a small desiccant to protect against condensation. Larger desiccants are necessary for deployment.

Jacket Options

Tefzel (vented) or thermoplastic polyurethane (TPU, vented or non-vented)

Customizable Cable Lengths

Cables can be ordered up to 1,219 m (4,000 ft).

Cable Termination

Cables can be ordered with a twist-lock termination (female connector) on both ends that connect to the instrument, the TROLL Com Communication Device, desiccant, and other accessories.

Cables can also be ordered with stripped-and-tinned termination for wiring to a data logger or controller using SDI-12 or Modbus communication protocol.



1	RuggedCable System with female to female connectors
2	Stripped-and-tinned RuggedCable System with female connector
3	Stripped-and-tinned RuggedCable System with male connector (short length that converts a cable with a twist-lock connector to a stripped-and-tinned cable)

Spot Checking Configuration

Take live readings with an Aqua TROLL 500, Rugged Cable, Wireless TROLL Com and a Bluetooth-enabled Android device.

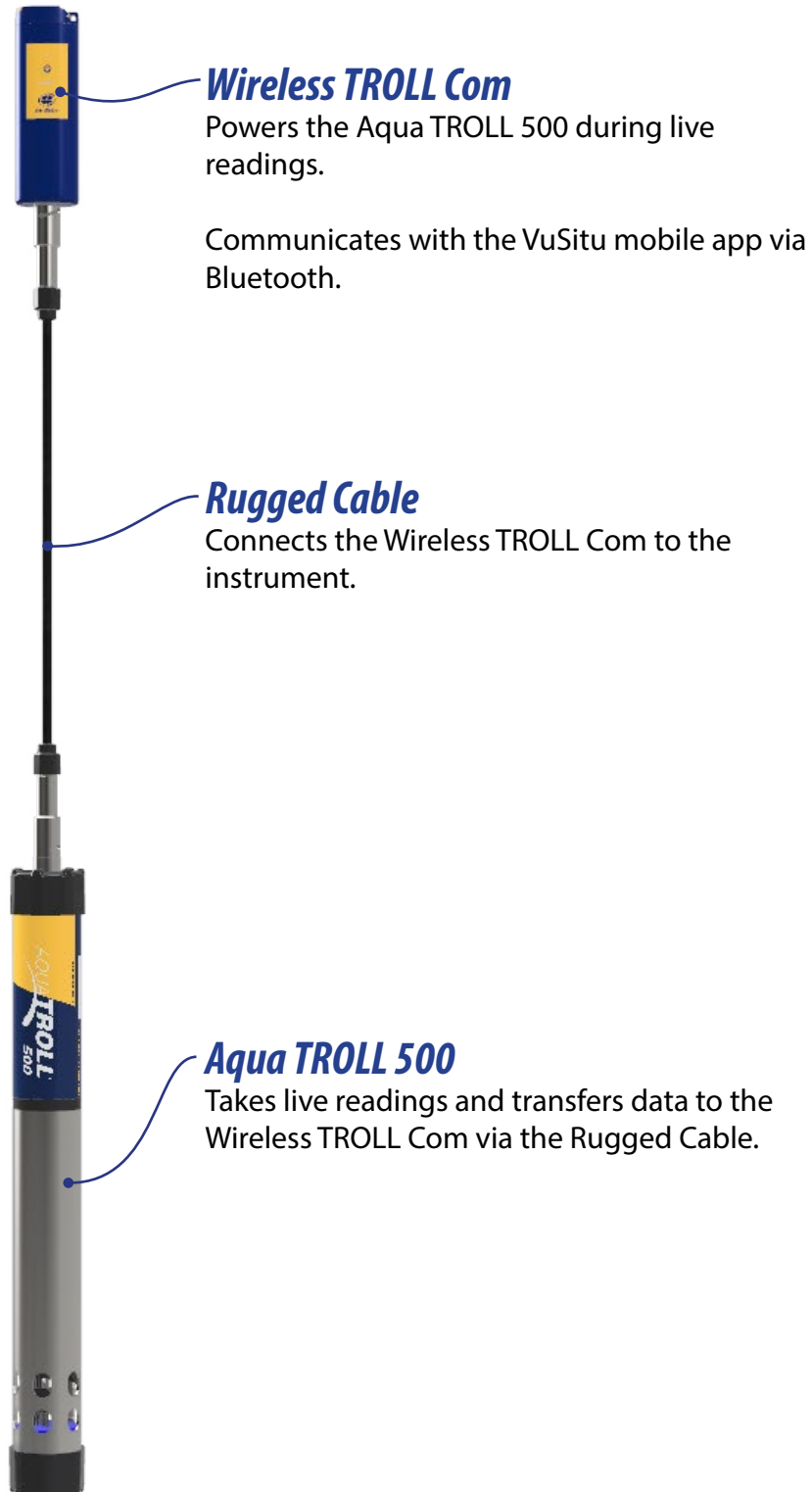

Getting Started (Spot-Checking)

Follow the steps below to set up and deploy the Aqua TROLL 500 when you intend to take live readings. See the next page for information about setting up and using the instrument in remote-monitoring applications.

1 *Unpack instrument.*

Remove sonde, sensors and maintenance supplies from box.

2 *Install RDO cap and pH/ORP sensor.*

- a. If your instrument includes a pH/ORP sensor, you'll need to install it prior to calibration and deployment.
- b. Install the RDO cap on the RDO sensor.

3 *Download and install software.*

- Download the VuSitu Mobile App from the Play Store or Apple Store.
- PC users download Win Situ 5 from www.in-situ.com

4 *Connect instrument to TROLL Com.*

- a. Attach the Rugged Cable to the TROLL Com and Aqua TROLL 500.
- b. Press power button on TROLL Com and pair with the VuSitu mobile app.

5 *Calibrate.*

Perform a single or multi-point calibration.

6 *Configure the instrument and take readings.*

- a. Create a site in VuSitu.
- b. Take readings in VuSitu's Snapshot or Live Readings mode.
- c. Save readings and share via email, SMS or cloud storage.

1 Install Wiper Motor and Sensors



Remove restrictor.



Apply a pea-sized drop of lubricant to O-rings.



Install wiper motor or port plug into center port.



Apply a pea-sized drop of lubricant to O-rings.

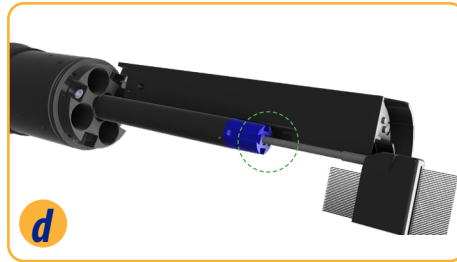

Align sensor with interlock groove in wiper motor and slide sensor into port.

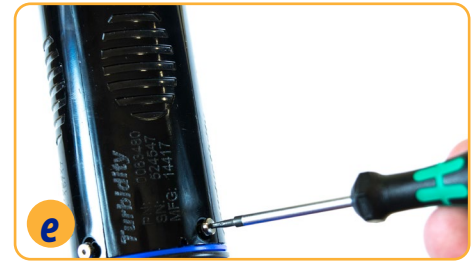

Tighten set-screw at base of each sensor.



Unscrew end cap from restrictor.



Flip restrictor and install with restrictor holes near center of instrument for calibration.



Flip restrictor and replace end cap before deployment.



When using a conductivity sensor and turbidity sensor together, install them side-by-side to maximize performance.

EFFICIENT
SENSOR CONFIGURATION
- END VIEW-

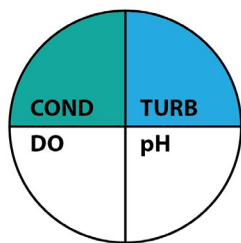

INEFFICIENT
SENSOR CONFIGURATION
- END VIEW-

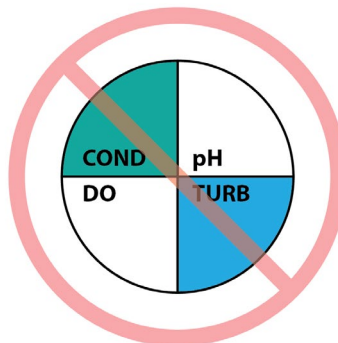

2 *Connect the cable to the instrument.*



Remove protective caps from instrument and cable.



Ensure O-ring on instrument connector is clean. Apply vacuum grease to O-ring.



Flat edge inside cable end must align with flat edge on instrument connector.



Hold textured sleeve of cable in one hand and instrument in other. Push and twist until click.

3 *Connect the communication device.*



If desiccant is present, remove it from cable.



Align TROLL Com connector with cable end. Push and twist until click.

4 Connect to the software.



You must have the VuSitu mobile app to use the instrument with a mobile device. Download VuSitu from the Google Play Store or the Apple App Store.

iOS

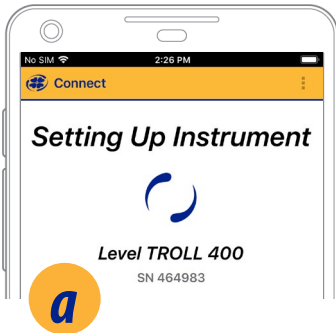

An iOS device automatically connects to the closest In-Situ instrument.

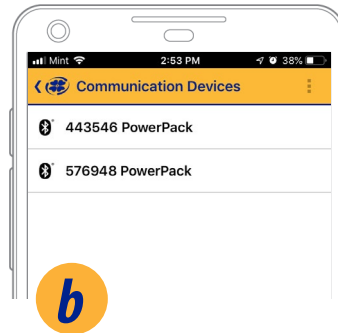

To connect to another instrument, press **Disconnect** and then **Choose or Add Device**. VuSitu displays a list of available connections.

Android

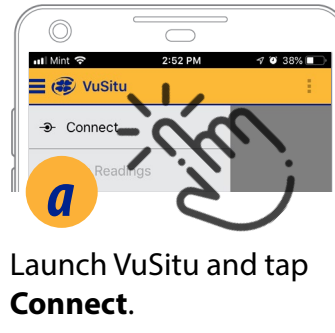

Launch VuSitu and tap **Connect**.

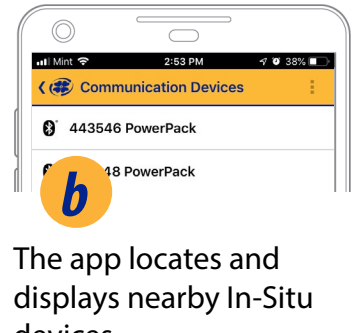

The app locates and displays nearby In-Situ devices.



Tap the serial number of the instrument or Wireless TROLL Com.

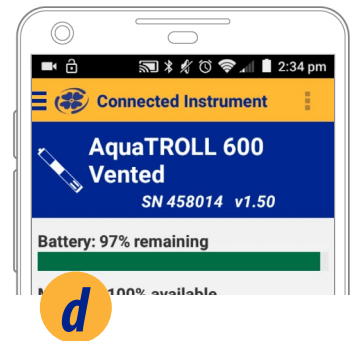

VuSitu displays the Connected Instrument screen when pairing is complete.

Connecting the TROLL Com



You must connect the Aqua TROLL 500 to a Wireless TROLL Com to calibrate the instrument, configure or take live readings.



Attach Rugged Cable to the Wireless TROLL Com.



Attach opposite end of cable to the Aqua TROLL 500.



Press power button.

Pairing the Instrument with the VuSitu Mobile App



Download and install the VuSitu mobile app from the Google Play store. Visit play.google.com on your Android device.

iOS

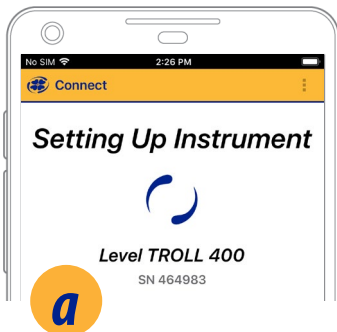

An iOS device automatically connects to the closest In-Situ instrument.

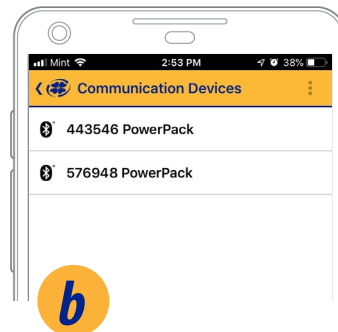

To connect to another instrument, press **Disconnect** and then **Choose or Add Device**. VuSitu displays a list of available connections.

Android

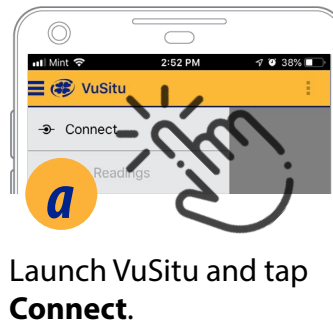

Launch VuSitu and tap **Connect**.

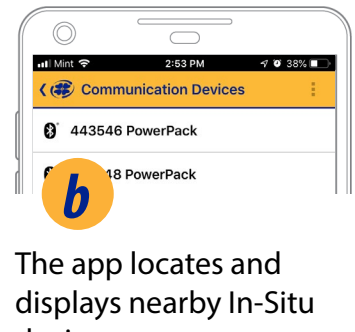

The app locates and displays nearby In-Situ devices.



Tap the serial number of the instrument or Wireless TROLL Com.

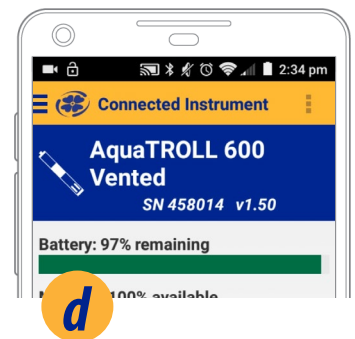

VuSitu displays the Connected Instrument screen when pairing is complete.

Parameters and Sensors

Using the RDO Sensor and Sensor Cap



The wiper can severely reduce the life of the RDO Fast Cap. Wear will vary by application. Verify sensor performance prior to use and replace the Fast Cap if damaged.

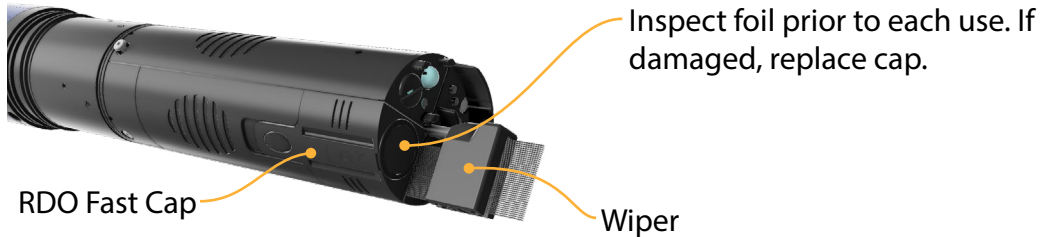

Do not look directly at the sensor LED or point it at the eyes. Doing so can cause eye damage.

Handling pH and Ion-Selective Electrode Sensors



Salt may accumulate around the reference junctions of the ammonium, chloride, nitrate and pH sensors. Rinse with deionized water to remove any buildup.



Before using the **ISE sensors** for the first time, replace the reference filling solution. Condition the sensors by soaking in calibration standard for 4-24 hours prior to deployment. This step is not necessary for the pH sensor.

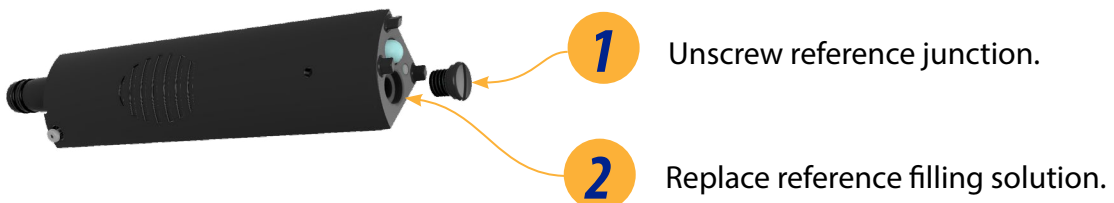

Using Ion-Selective Electrode Sensors



ISE sensors require one or more additional sensors to function. See the details below and install the required sensors to use an ISE.

Ammonium Sensor Requirements

**Conductivity/
Temperature Sensor**



or

Temperature Sensor



To calculate ammonia...

**Conductivity/
Temperature Sensor**



and

pH Sensor



Chloride, Nitrate, and pH/ORP Sensor Requirements

**Conductivity/
Temperature Sensor**



or

Temperature Sensor



Derived Parameters

VuSitu can derive estimates for additional parameters based on correlations with measured parameters. Scale factors for derived parameters are unique for each deployment site, so they must be determined by laboratory analysis of grab samples. Examples of derived parameters include:

- TDS (Derived from Conductivity and Temperature)
- TSS (Derived from Turbidity and Temperature)
- BGA-PC and BGA-PE Concentration (Derived from Relative Fluorescence)
- Chlorophyll a Concentration (Derived from Relative Fluorescence)
- Chlorophyll a Cell Count (Derived from Relative Fluorescence)
- FDOM Concentration (Derived from Relative Fluorescence)
- Crude Oil Concentration (Derived from Relative Fluorescence)

Enable derived parameters and input a scale factor in VuSitu under **Instrument Settings > Derived Parameters**.

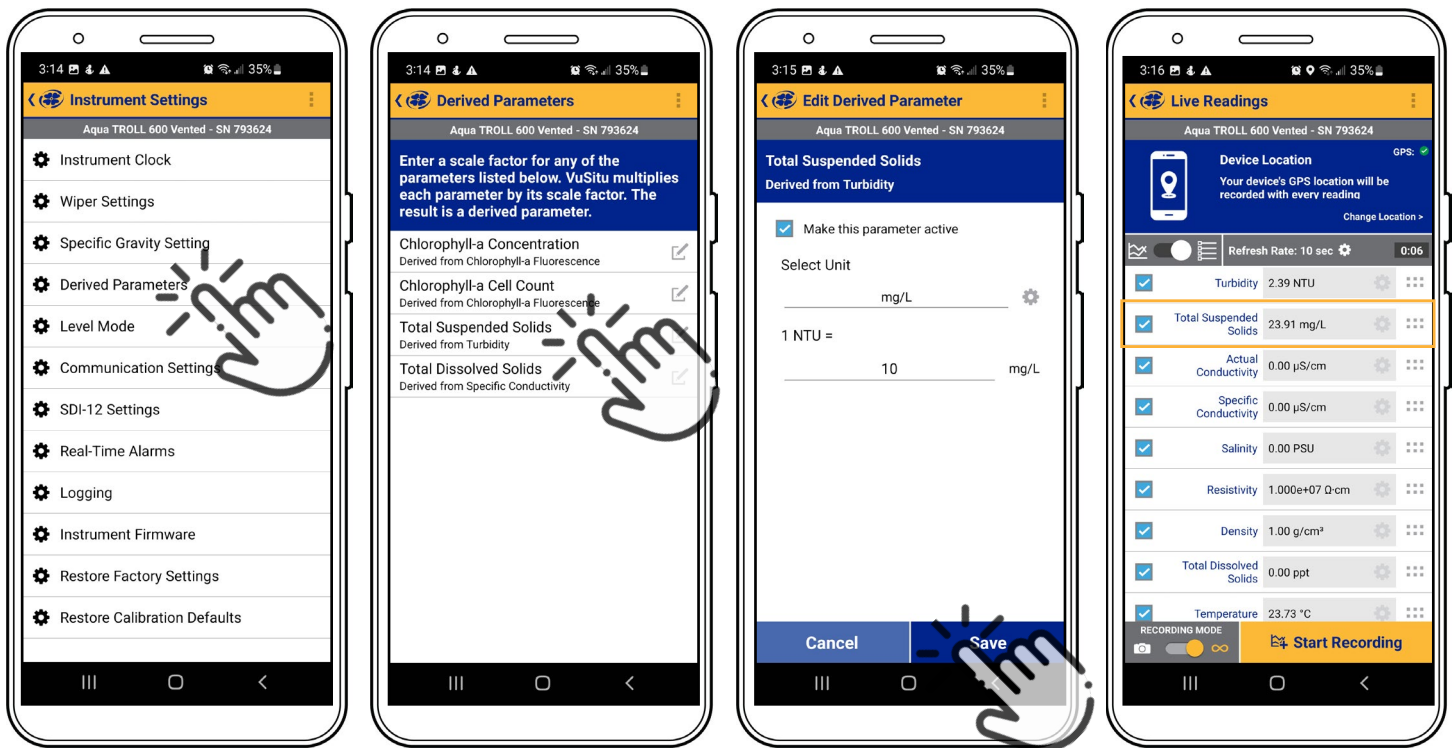

Select **Derived Parameters** in the **Instrument Settings** menu.

View the list of available derived parameters. Select the edit icon to configure a parameter.

Select units and enter a linear scale factor. Scale factors are highly site-specific and must be determined by laboratory analysis of grab samples.

The derived parameter is now listed next to measured parameters.

LCD Screen



View instrument status and access settings via the LCD screen. The sonde must be connected to a Wireless TROLL Com or other power source to use the LCD screen.

Accessing the LCD Menu



LCD screen will display sensor status on activation.



Hold instrument horizontally and slowly tap Aqua TROLL 500 logo 3-4 times to view the main menu.



Tilt instrument left or right to scroll through menu options.



Select an item when its background turns black by tapping the instrument once.

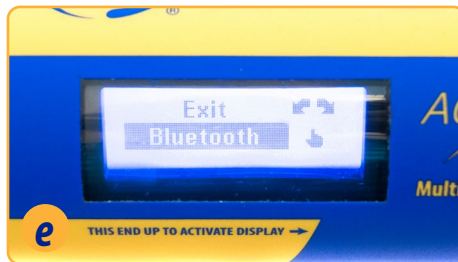

You can enable Bluetooth communication directly with the sonde via the Bluetooth menu option.

LCD Status Indicators



1. Port Status
2. Power Status
3. Connection Status

Possible Port Statuses



Sensors installed



Port plugs installed



Sensor/port error

Possible Power Statuses



Power level within specs



Power level NOT within specs

Possible Connected Statuses



Connected via Bluetooth



Connected via cable

Error Messages



Install All Sensors!

Port(s) empty



RDO Cap expired!

RDO cap is reaching the end of its expected lifespan.

Full-Text Messages

The LCD will display text messages instead of status icons when certain conditions are met. Multiple messages will rotate and display for 3 seconds each.

Text Message	Cause and Remedy
Close battery cover	Battery cover is not fully closed. Ensure the battery cover is securely tightened.
Install wiper	Wiper sensor port is open. Install wiper or wiper port plug into center port.
Install sensors	Sensor ports are open. Install sensors or sensor port plugs.
Install temperature	No Temperature or Conductivity/Temperature sensor detected. Install a sensor with Temperature.
Install RDO Cap	RDO Cap not detected on RDO sensor. Install RDO cap.
RDO Cap expired	RDO cap is reaching the end of its expected lifespan. Install a new RDO Cap if it is worn or damaged or if sensor is not calibrating properly..
RDO Cap XXX days	Temporary text message update on the lifespan of the RDO Cap.

Calibrating Sensors

Solution-Based Calibration

Use the solution-based procedure described below to calibrate all sensors except RDO. You will need the following items.

- Calibration standard, or multiple standards for multi-point calibrations
- Wireless TROLL Com connected to the Aqua TROLL 500
- Bluetooth-enabled Android device



Connect the sonde to a Wireless TROLL Com and pair with VuSitu.

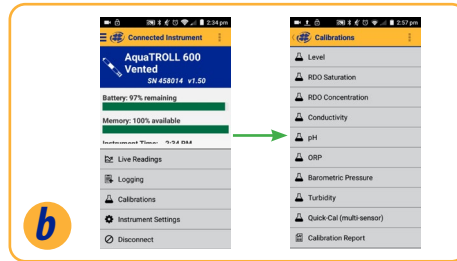

In VuSitu, click Calibrations from the Connected Instrument screen and choose sensor to calibrate.



Remove cap from instrument and pour 10-20 ml of DI water into restrictor.



Gently shake the sonde in a circular motion to rinse the inside of restrictor and sensors.



Discard the DI water and repeat rinsing procedure two more times with 10-20 mL of your first calibration standard.

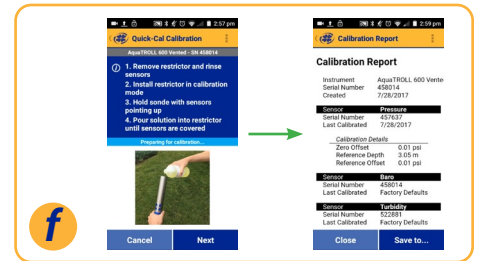

Pour calibration solution into the restrictor 1 cm above the sensors and cover with the end cap. Follow the instructions in VuSitu to start the calibration.

Turbidity Sensor Calibration



You must calibrate the turbidity sensor with In-Situ's turbidity standard or formazin. The app may not automatically detect the formazin concentration. Instead, a field will appear in which you can enter the appropriate value. Select **Set User Defined** to begin calibrating with the new value. If you are using an In-Situ standard and the app does not automatically detect it, perform the sensor cleaning and maintenance procedure, then select **Retry Auto Detect**.

Fluorometer Calibration



Fluorometer sensors (BGA-PC, BGA-PE, Chlorophyll-A, FDOM, Crude Oil, Fluorescein, and Rhodamine) require more calibration solution than other solution-based calibrations. Use a solid-state calibrator for fluorometer calibrations if one is available. If solution-based calibration is required, fill the restrictor up to the threads for accurate calibration.

RDO 100% Saturation Calibration: Water Saturated Air

Use the procedure below to calibrate the Aqua TROLL 500 RDO sensor, or see the next section for an alternative method.



Place the restrictor in calibration mode (holes near center of instrument).

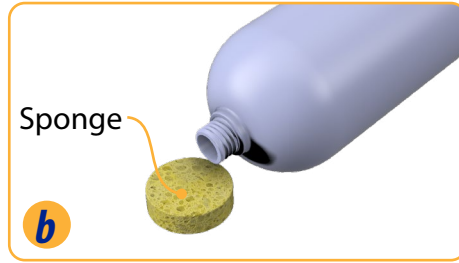

Saturate a small sponge with water.



Place the sponge on the restrictor cap.

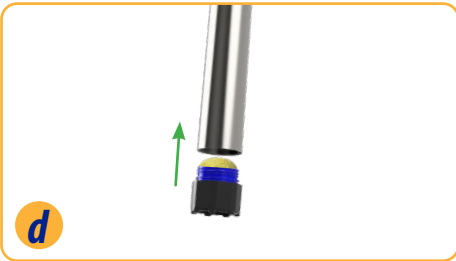

Loosely install the end cap, keeping the sensor face dry and allowing for air flow.



Leave sponge in restrictor for five minutes.

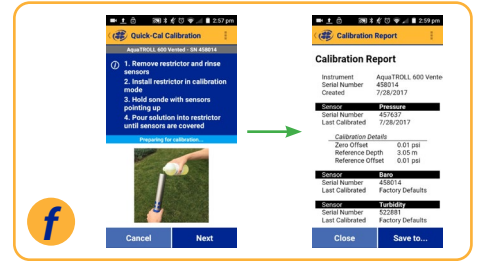

Follow the instructions in VuSitu to finish calibration.

RDO 100% Saturation Calibration: Saturation Bubbler



Fill a 100% saturation bubbler two-thirds with tap water.



Turn on bubbler and allow 5-10 minutes for 100% saturation.

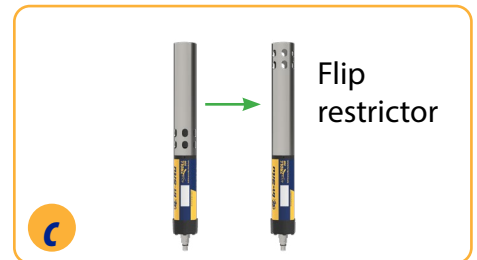

Put sonde into deployment mode by flipping restrictor 180 degrees.



Place sonde into bubbler.

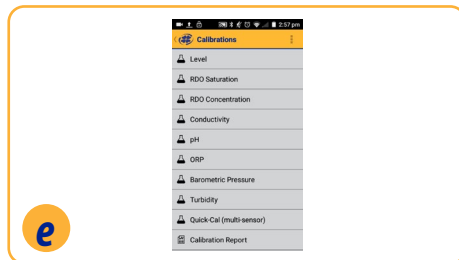

Open the VuSitu mobile app and tap Calibrations > RDO Saturation.

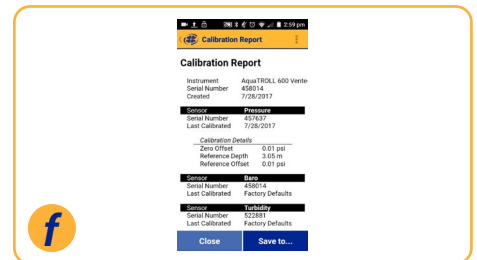

Follow instructions in VuSitu to finish calibration.

RDO Salinity Setting

The Aqua TROLL 500 includes automatic salinity compensation. This feature requires a conductivity sensor and RDO sensor. With both sensors installed, the sonde will use salinity compensation by default. To change the compensation value, follow these steps:

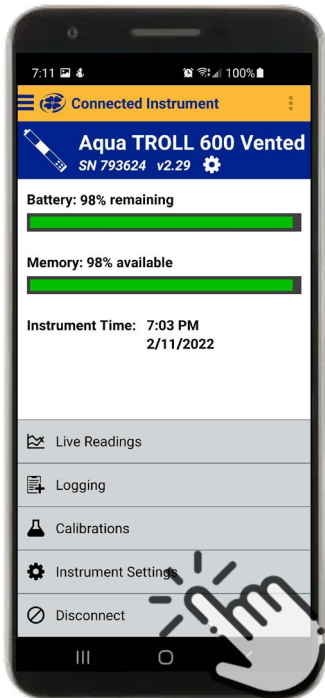

Select **Instrument Settings** from the menu at the bottom of the screen.

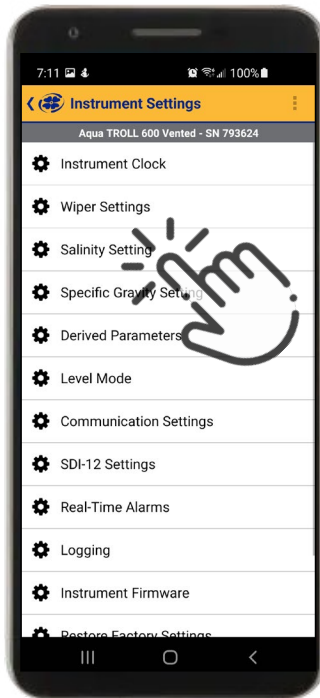

From the Instrument Settings menu, select **Salinity Setting**.

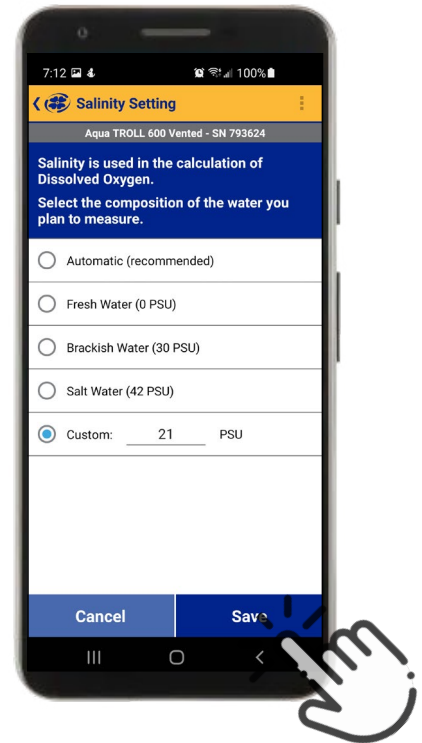

Enter your desired salinity compensation setting and press **Save**.

Reported Depth

If a pressure sensor is included, the Aqua TROLL 500 uses its pressure reading and specific gravity value to calculate depth. The pressure sensor is located at the center of the instrument, but depth is reported at the smart sensor faces. An embedded gyroscope compensates for the distance between these sensors and allows the sonde to be deployed in any orientation (vertical, horizontal, angled).

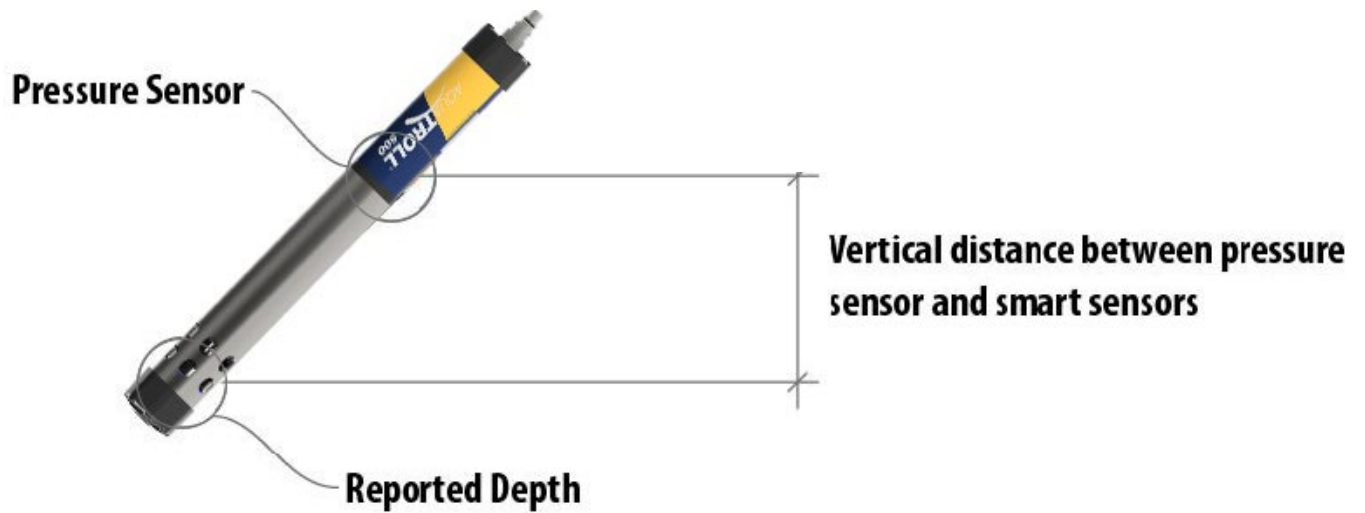

Calibration Frequency Recommendations

In-Situ sensors are factory calibrated across the entire range of each sensor, and thus achieve a very high degree of accuracy and stability for extended periods of time without user calibration. In-Situ recommends inserting the instrument into a known calibration standard to check the accuracy of a sensor prior to performing any user calibration if you suspect drift, unless a user calibration is required by a standard operating procedure.

Sensor	Recommended User Calibration Frequency	Recommended Factory Calibration Frequency	Notes
Conductivity	Only when required by user protocol	12 months	K-cell value: 0.7 to 1.3
Conductivity + Temperature	Only when required by user protocol	12 months	K-cell value: 0.7 to 1.3
pH	10 to 12 weeks or as required by user protocol or site conditions	12 months	Single point: Theoretical mV ± 30 mV 2- or 3-point Slope: -66 to 50 mV/pH 2- or 3-point Offset: ± 30 mV at pH 7
ORP	10 to 12 weeks or as required by user protocol or site conditions	12 months	Offset: ± 30 mV
RDO	12 months or as required by user protocol	12 months	2-point Slope: 0.7 to 1.3 2-point Offset: ± 0.3 mg/L
Temperature	Only when required by user protocol	Only when required by user protocol	Offset: ± 0.5
Turbidity	Only when required by user protocol	12 months	Slope: 0.7 to 1.3
Pressure/Depth	Only when required by user protocol	Only when required by user protocol	<2 times the full scale accuracy specification
Barometer	Only when required by user protocol	Only when required by user protocol	<2 times the full scale accuracy specification
Ammonium	Monthly	N/A	Slope > 20 mV/decade
Chloride	Monthly	N/A	Slope < -20 mV/decade
Nitrate	Monthly	N/A	Slope < -20 mV/decade

Chlorophyll a	Only when required by user protocol	12 months	
BGA-PC	Only when required by user protocol	12 months	
BGA-PE	Only when required by user protocol	12 months	
Rhodamine WT	Only when required by user protocol	12 months	
Fluorescein WT	Only when required by user protocol	12 months	
FDOM	Only when required by user protocol	12 months	
Crude Oil	Only when required by user protocol	12 months	

Factory Calibration

Factory calibration includes a thorough cleaning, full functionality check and sensor adjustments to all applicable sensors over the entire calibrated temperature range. We recommend a factory calibration every 12 months or when the unit appears to drift significantly.

Batch Calibrating Sensors in VuSitu

Different Sensor Types (Quick Cal Solution)



Use Quick Cal standard to calibrate conductivity, pH, and ORP with a single solution. Quick Cal solution can also be used for 100% RDO Saturation calibration. To calibrate multiple sensors of the same type, follow the instructions on the next page.



1 Install the restrictor in calibration mode (with holes closest to the instrument body).



2 In VuSitu, click **Calibrations** from the Connected Instrument screen. Choose **Quick Cal** from the menu.

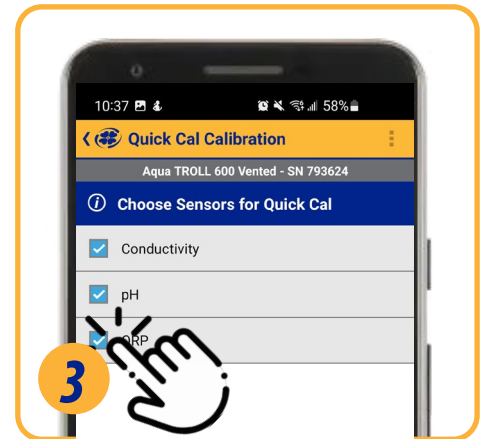

3 Select sensors to calibrate.



4 Set up the calibration. Make sure that all sensors are completely submerged.



5 When all sensors have stabilized, tap **Accept**. Review the calibration report for the completed sensors.



6 Flip the restrictor back into deployment mode and install the end cap.

Multiple Sensors of the Same Type



For some parameters (pH, ORP, RDO, turbidity, and conductivity), you can calibrate multiple sensors of the same type together. Use this feature when you need to batch calibrate a group of sensors prior to field deployment.



1
Install the sensors to calibrate. (pH/ORP sensors also require a temperature sensor.) Install the restrictor in calibration mode.

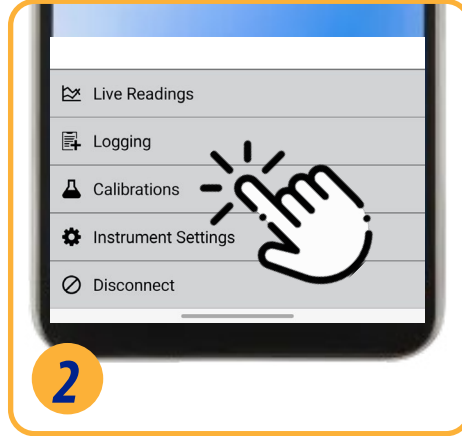

2
In VuSitu, click **Calibrations** from the Connected Instrument screen. Choose a calibration to perform.



3
Set up the calibration. Make sure that all sensors are completely submerged or in the same calibration environment.



4
Wait for calibrations to complete. If one sensor isn't stabilizing, use the toggle switch to turn that sensor off and continue calibrating the others.

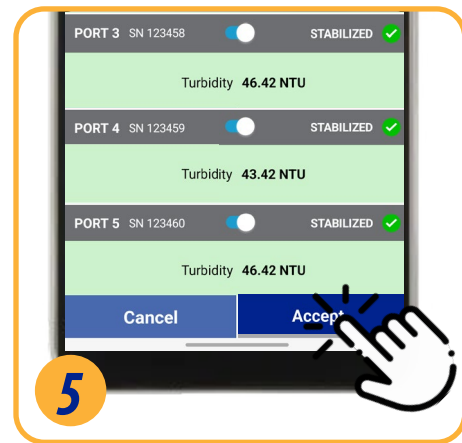

5
When all sensors have stabilized, tap **Accept**. Review the calibration report for the completed sensors.



6
Remove sensors and install them in the instruments they will be deployed in.

Navigating VuSitu

Program your Aqua TROLL® 500 with the VuSitu mobile app for Android or iOS. Or use Win-Situ 5 software for a desktop PC.

VuSitu Mobile App



To avoid potential compatibility issues, it is important to use the most recent version of the VuSitu Mobile App. Install the latest version from the Google Play Store or Apple App Store.

Connecting with Bluetooth

The Aqua TROLL 500 can connect to a Bluetooth-enabled device for wireless communication with the VuSitu mobile app.

- If the Aqua TROLL 500 is connected to a Wireless TROLL Com, press the button on the Wireless TROLL Com. Then open VuSitu to connect.
- If the Aqua TROLL 500 is connected to another power source, turn on the Aqua TROLL 500 LCD screen by holding the sonde vertical with the sensor end facing up. Then open VuSitu to connect.

Connected Instrument Screen

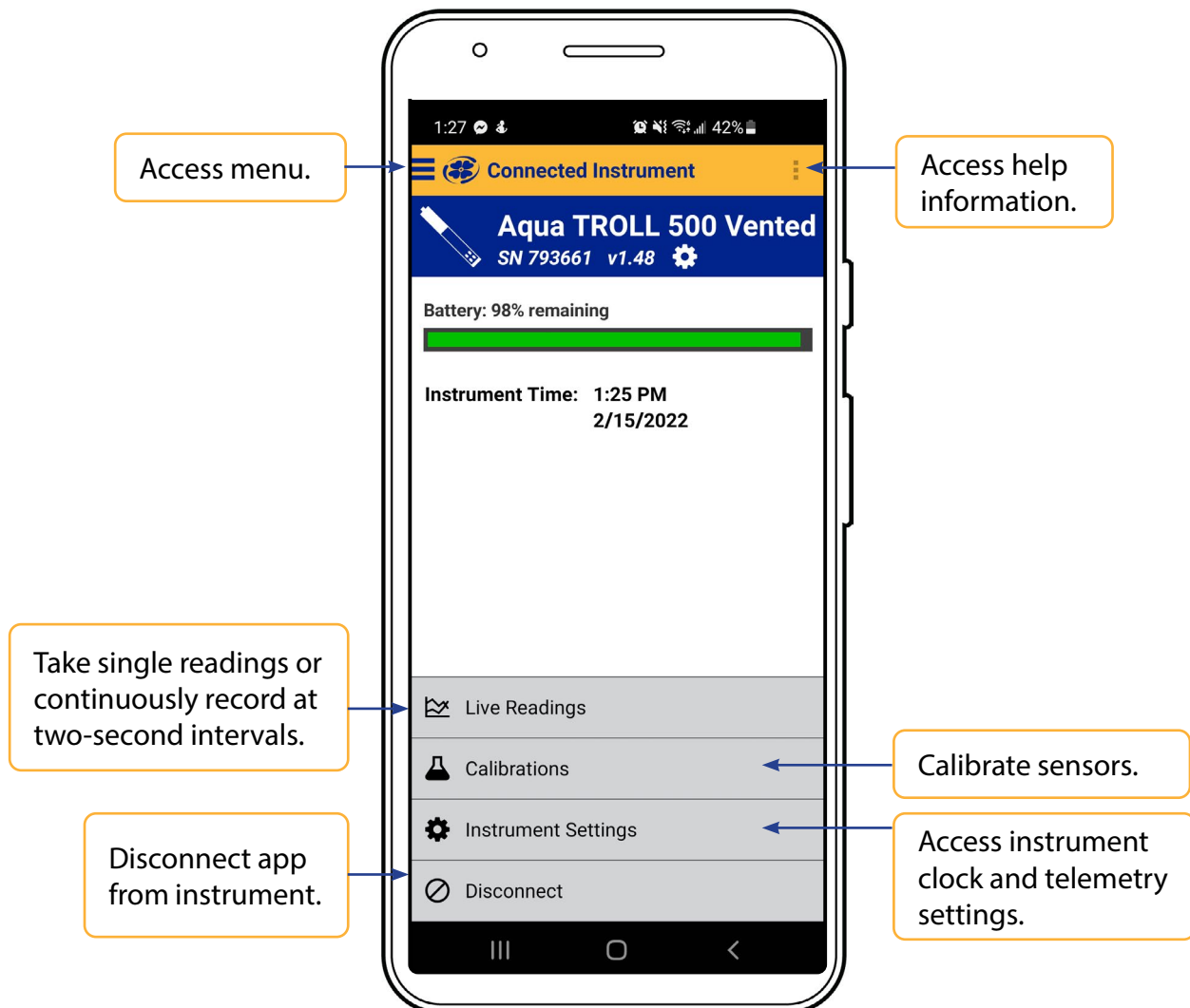

VuSitu Menu Options



The features available in the VuSitu mobile app vary slightly depending on the instrument to which it is connected.

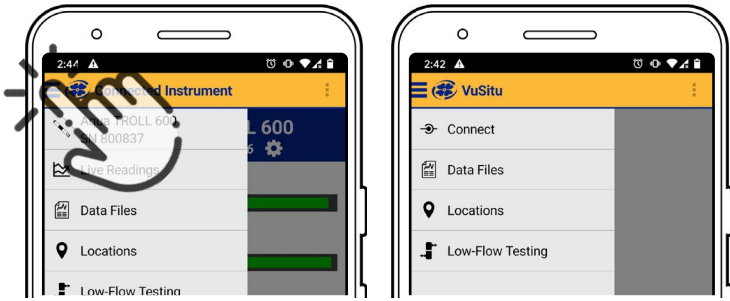

Tap the menu icon in the upper left portion of the screen to view options. Tap the icon again to close.

Some features aren't available when VuSitu isn't connected to an instrument.

Selecting with Long-press and Swipe

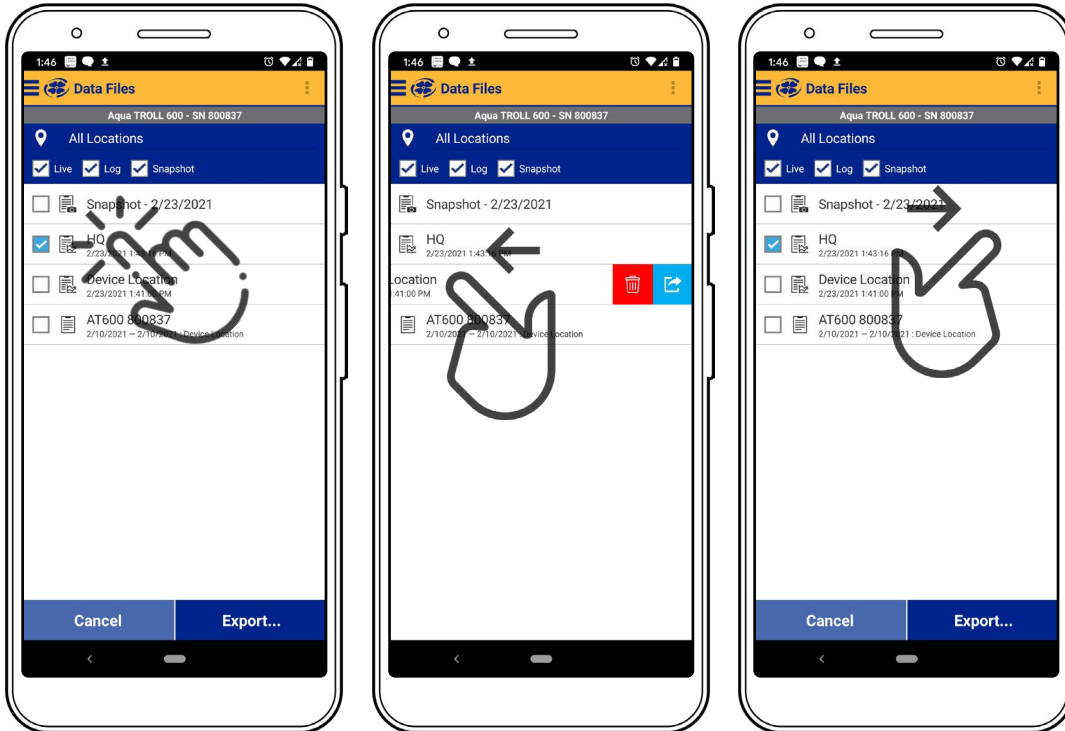

Press and hold any item in a list of files. You can now select multiple files.

Press and swipe left to reveal the delete and share icons.

Press and swipe right to reveal the sharing icon.

Live Readings in VuSitu



The live readings screen displays measurements taken from the instrument every two seconds. You can save these readings and share them via email or cloud storage.

Snapshot Mode

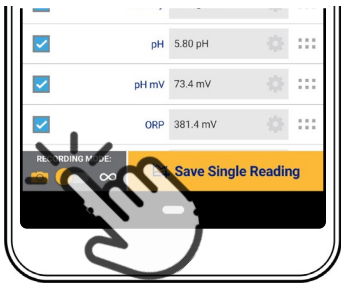

Tap the button on the bottom left to toggle between snapshot and live readings modes.

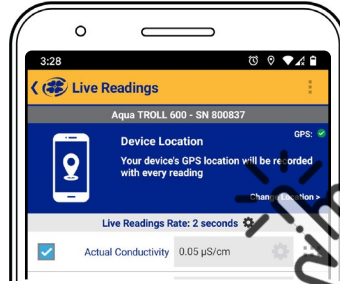

Tap **Change Location** in the top right corner if you wish to associate this data with a different location.

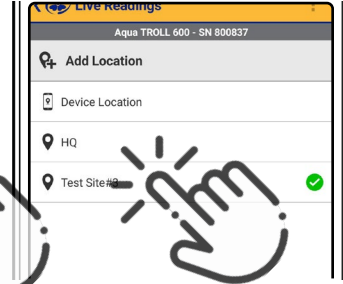

Choose the desired location and press **Save** in the bottom right corner of the screen.

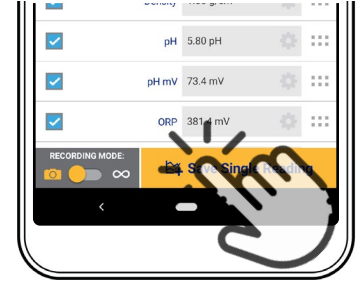

Tap **Save Single Reading** to create a snapshot.

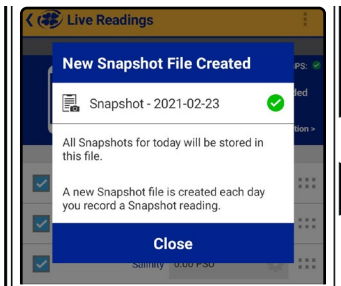

VuSitu confirms the new snapshot file.

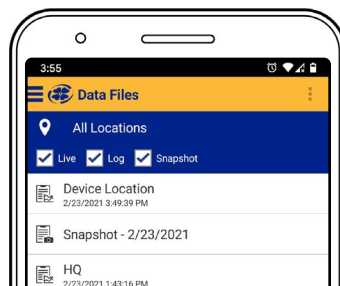

View the file from the Data Files screen.

Live Readings Mode

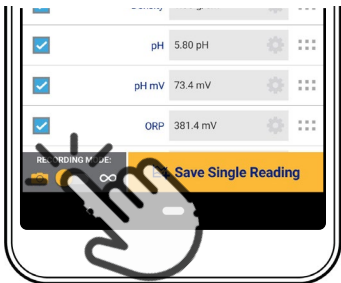

Tap the button on the bottom left to switch from snapshot mode to live readings mode.



Tap **Start Recording**. The instrument takes a reading every two seconds.

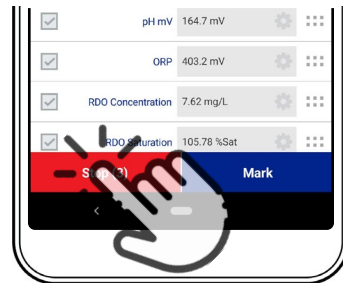

Tap **Stop** to end the recording. VuSitu displays a summary of the live readings data.

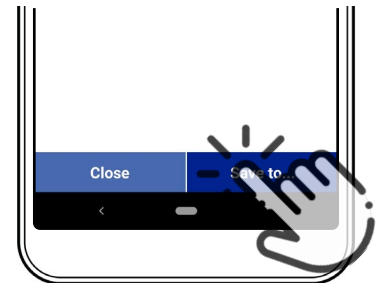

Tap **Save to** if you wish to share the Live Readings file via email or cloud storage.

VuSitu Data



You can transfer a data file from your mobile device to a PC via Bluetooth, email it to yourself or any valid email address, or upload it to Google Drive.

Sharing Data

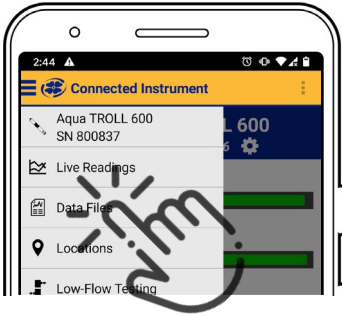

Select **Data Files** from the menu at the top left corner of the screen.

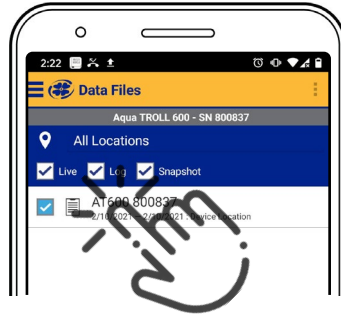

Tap and hold the name of the log you want to share.

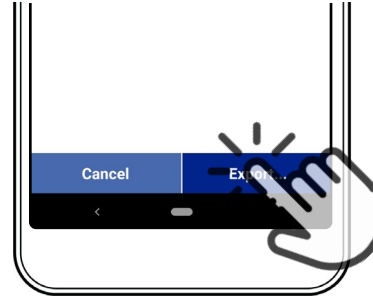

Select **Export**.

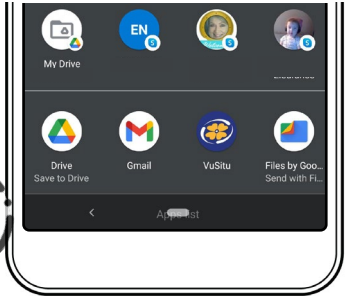

Choose email, cloud storage, or another sharing option.



To save data locally on your mobile device, export to a third-party file management app.

Viewing Data on a Mac or PC



You'll need to extract your files to view them. To do that on a Mac, double-click the Zip folder. On a PC, right-click on the folder and choose **Extract**. Then open your files in Excel.

VuSitu Locations

About VuSitu Locations

A VuSitu location represents the physical spot where an instrument collects data. You can create a VuSitu location for any monitoring site. If you don't create a location, your data defaults to "Device Location." Location names appear on the live readings screen, in snapshot files, and in log files.

How to Create a Location

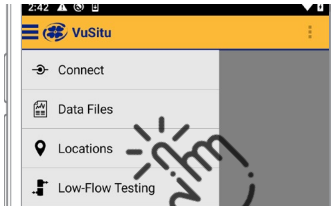

Select **Locations** from the main menu.

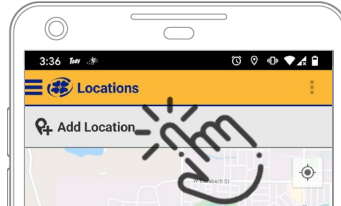

Tap **Add Location**.

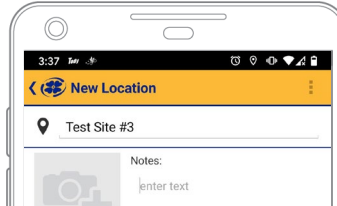

Enter a name for the location. You can also add notes.

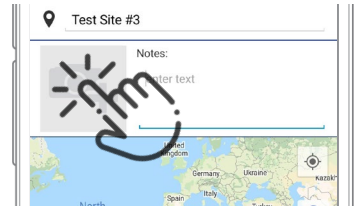

If desired, tap the camera icon to take a photo of the new location.

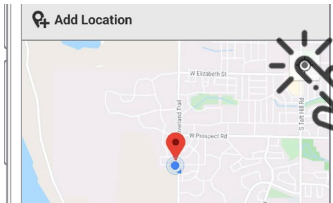

To home in on your mobile device's current location, tap the button on the top right.

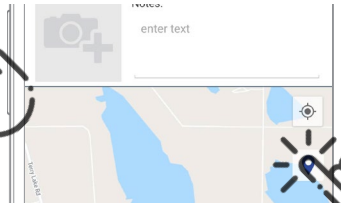

Tap the pin icon to establish the location on the map.



As an alternative, you can manually enter latitude and longitude values and tap **Apply**. Or, tap and hold a specific point on the map to drop a pin there.

How to Edit or Delete a Location

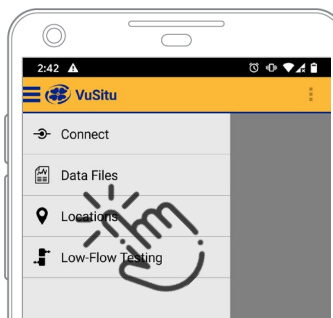

Select **Locations** from the app menu.

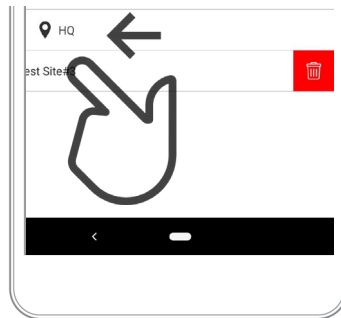

Tap the location you wish to delete and swipe left. Tap the trash icon.

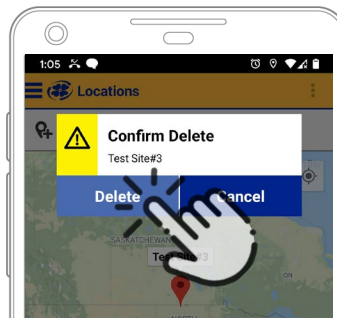

Confirm by tapping **Delete**.

How to Select a Location



Data is associated with the Location that is displayed on the Live readings screen. After you have created a Location, you must select it in order for your data to be associated with the Location.

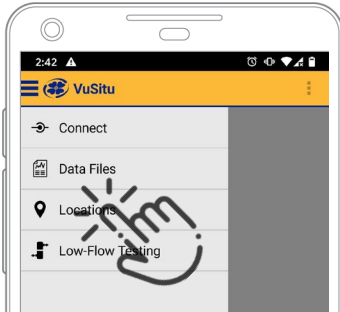

Select **Locations** from the app menu.

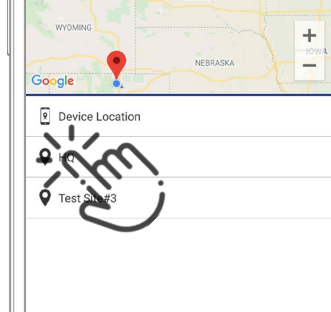

Tap a location to select it.

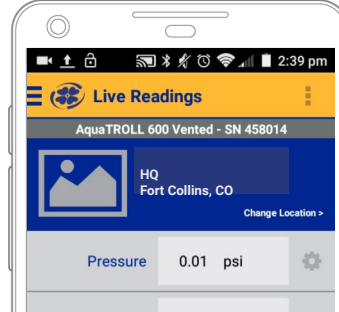

New live readings data will be associated with this location until you select another.

Remote-Monitoring Configuration (Telemetry)



VuLink provides power to the Aqua TROLL 500 and uploads data to the HydroVu Data server.

1 Remove the battery pull-tab.



Remove the battery cover by twisting it counter-clockwise and pulling down.



Remove the yellow pull tab to allow current to flow through the batteries.



Never mix old and new batteries, or Lithium and alkaline batteries. Make sure all three batteries are installed in the same orientation.

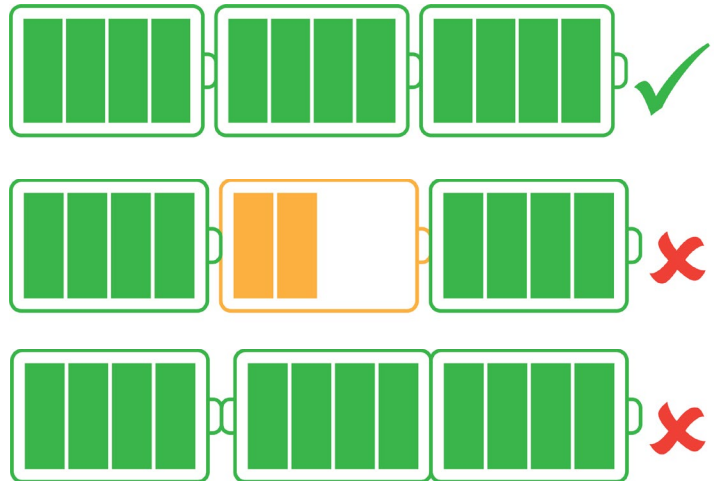

2 Connect the instrument.



Align the flat edge of the connector with the flat edge inside the cable.



Twist the cable until it clicks into the secure position.



Connect the cable to your instrument.

3 Press the button on the VuLink control panel.



Connecting to a cellular network can take up to 10 minutes in the following situations:
The first time VuLink powers up
When VuLink hasn't been powered up in several weeks or months



Pressing the button starts the instrument connection process.



All LEDs turn green for one second. The battery status LED changes according to power level.



Next, the connection status LED and Bluetooth status LED blink.



The connection status LED turns solid green, indicating VuLink is connected to an instrument.



Once linked to an instrument, VuLink attempts to connect to a data network.



When the modem status LED turns green, VuLink begins connecting to HydroVu. The data LED blinks.



All LEDs except the Bluetooth status indicator turn green.



By default, VuLink reads all available parameters every hour and transmits to the cloud once daily. You can also connect to the VuLink using the VuSitu Mobile App to configure a custom log. See the VuLink manual for more information.

HydroVu



HydroVu is a data-management application that runs in the browser. Use it to manage data, view graphs, and configure telemetry devices for remote monitoring. See it at www.hydrovu.com.

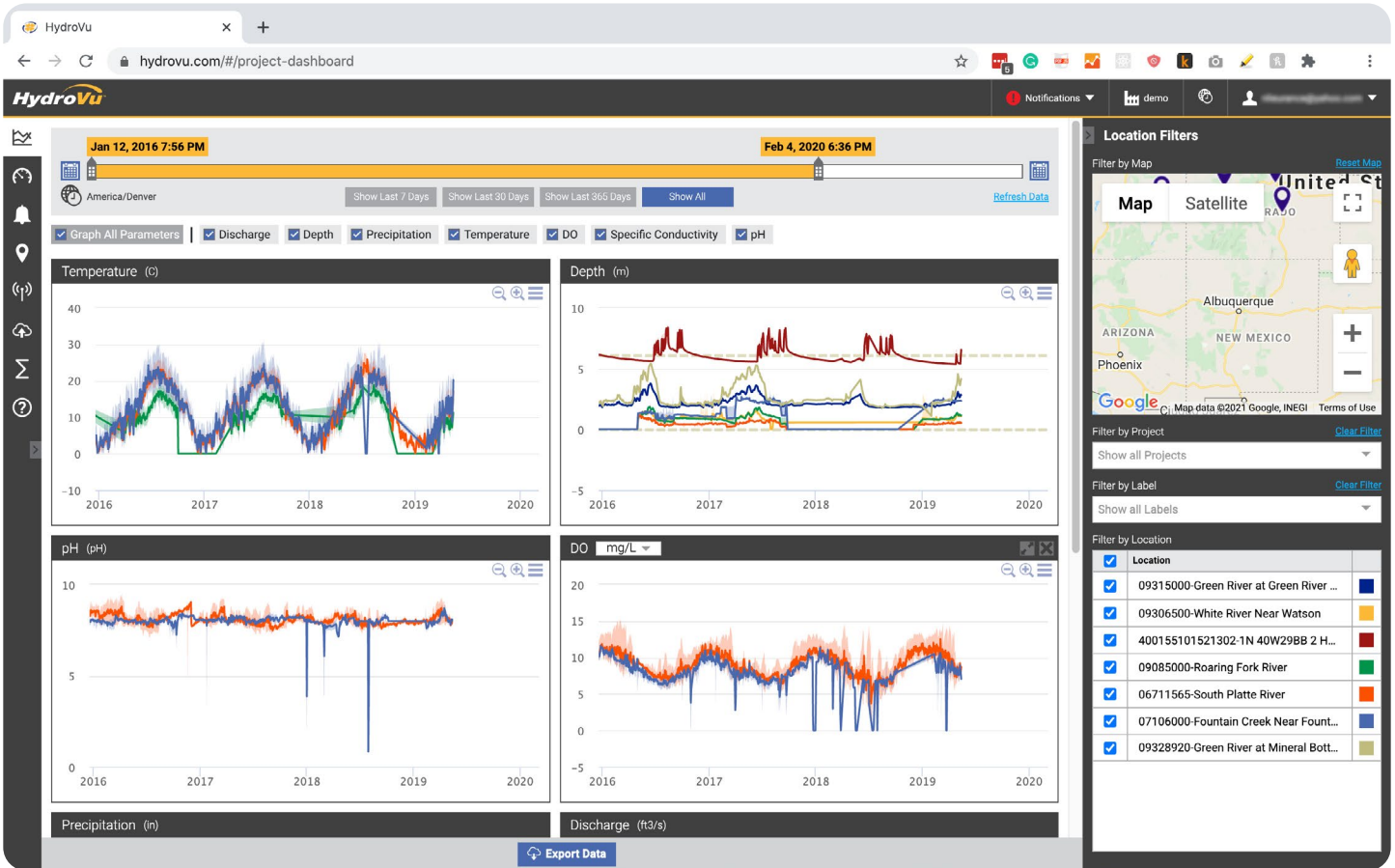

Connecting to Win-Situ on a PC

Connecting to Win-Situ via USB



Download and install Win-Situ by visiting www.in-situ.com. The Wireless TROLL Com must be connected to the sonde and powered on to connect the instrument to Win-Situ.



You can connect a Wireless TROLL Com to a PC with the included USB cable. Plug the cable into the port at the top of the TROLL Com and the USB port on your PC.

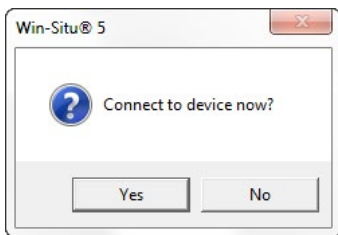
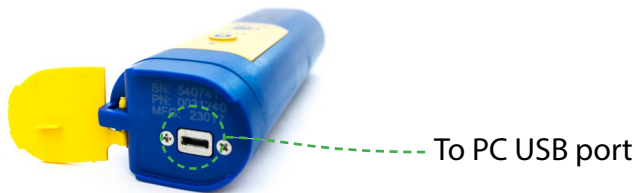

Open Win-Situ. Select **No** when asked to connect now.

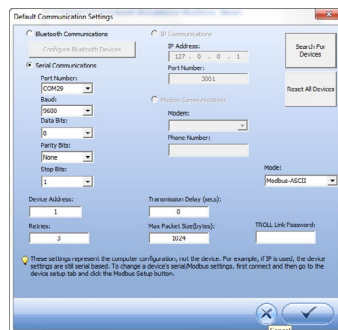

Click Preferences > Com Settings from menu bar and choose correct com port. Select Serial Communications button. Click check mark button.



Click the yellow connect button at the bottom right of the screen.

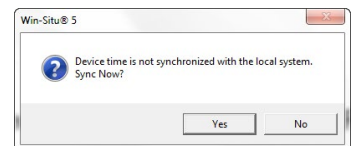

Click Yes if prompted to sync device time with local system.

Navigating the Win-Situ Interface

Home Tab

The screenshot shows the Home Tab interface with the following data:

- Time: 9:55:07 AM
- Temperature - C: 22.976
- Pressure - PSI: 0.474
- Depth - ft: 1.095

Navigation callouts include:

- Display Sites list (points to the Sites icon in the top left)
- View data files (points to the Data Files icon in the top right)
- Meter view (points to the Meter view icon in the bottom toolbar)
- List view (points to the List view icon in the bottom toolbar)
- Graph view (points to the Graph view icon in the bottom toolbar)
- Record snapshot (points to the Record snapshot icon in the bottom toolbar)
- Record current values (points to the Record current values icon in the bottom toolbar)

Sensor Tab

The screenshot shows the Sensor Tab interface with the following configuration details:

Sensor	Serial Number	Factory Cal Date	Field Factory Cal Date	Last User Cal Date	Next User Cal Date
PressureTemp	15 P330 (...)	166274	7/2/2010 2:57:15 PM	9/21/2017 4:09:39 PM	

Navigation callouts include:

- Set up sensor (double-click) (points to the 'Sensor' button in the top left)
- Calibrate sensor (points to the 'Calibrate' button in the bottom toolbar)
- Set up sensor (points to the 'Set up sensor' button in the bottom toolbar)

Device Setup Tab

The screenshot displays the 'Device Setup' software interface. The main window shows device information, status, and power management options. Three orange arrows point from the 'Analog Setup...', 'SDI-12 Setup...', and 'Alarm Setup...' buttons in the main interface to their respective pop-up windows.

Analog Setup

- Sensor: Pres(G) 35ft
- Parameter: Pressure
- Zero Scale (4mA): Value 0 PSI
- Full Scale (20mA): Value 15 PSI
- Options: Disable Analog Output, Enable Analog Output

SDI-12 Setup

- Address Character: 0
- Sensor: Pres(G) 35ft
- Parameter: Pressure
- Output Order:
 - Pres(G) 35ft - Pressure - PSI
 - Pres(G) 35ft - Temperature - C

Serial Communication Settings

- Device Address: 1 (1-247)
- Serial Communications:
 - Baud: 19200
 - Data Bits: 8
 - Parity Bits: Even
 - Stop Bits: 1
- End Of Message Timeout (ms): 1000
- End Of Session Timeout (ms): 10000
- Mode: Modbus-RTU

Alarm Setup

- Sensor: Pres(G) 35ft
- Alarm Parameter: Pressure
- Warning:
 - Enable Low:
 - Enable High:
 - Low Setpoint: 0 PSI
 - Low Reset: 0 PSI
 - High Setpoint: 0 PSI
 - High Reset: 0 PSI
- Alarm:
 - Enable Low:
 - Enable High:
 - Low Setpoint: 0 PSI
 - Low Reset: 0 PSI
 - High Setpoint: 0 PSI
 - High Reset: 0 PSI

Connecting the Aqua TROLL 500 to a PLC or Data Logger

Flying Leads Wire Diagram



Refer to the diagrams on the following pages for PLC wiring diagrams. Unused leads should not be touching.

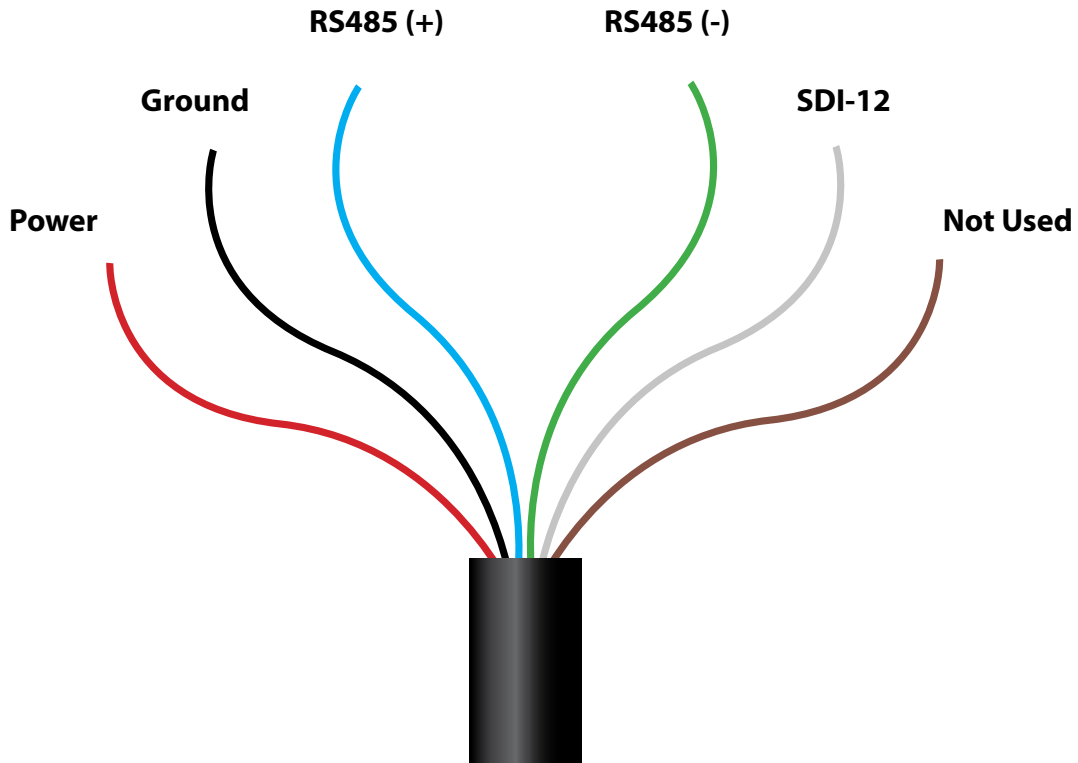

Flying Leads Cable Wire Legend

Wire Color	Signal
Red	External Power
Black	Ground
Blue	RS485 (+)
Green	RS485 (-)
White	SDI-12
Brown	Not Used

SDI-12 3 Wire

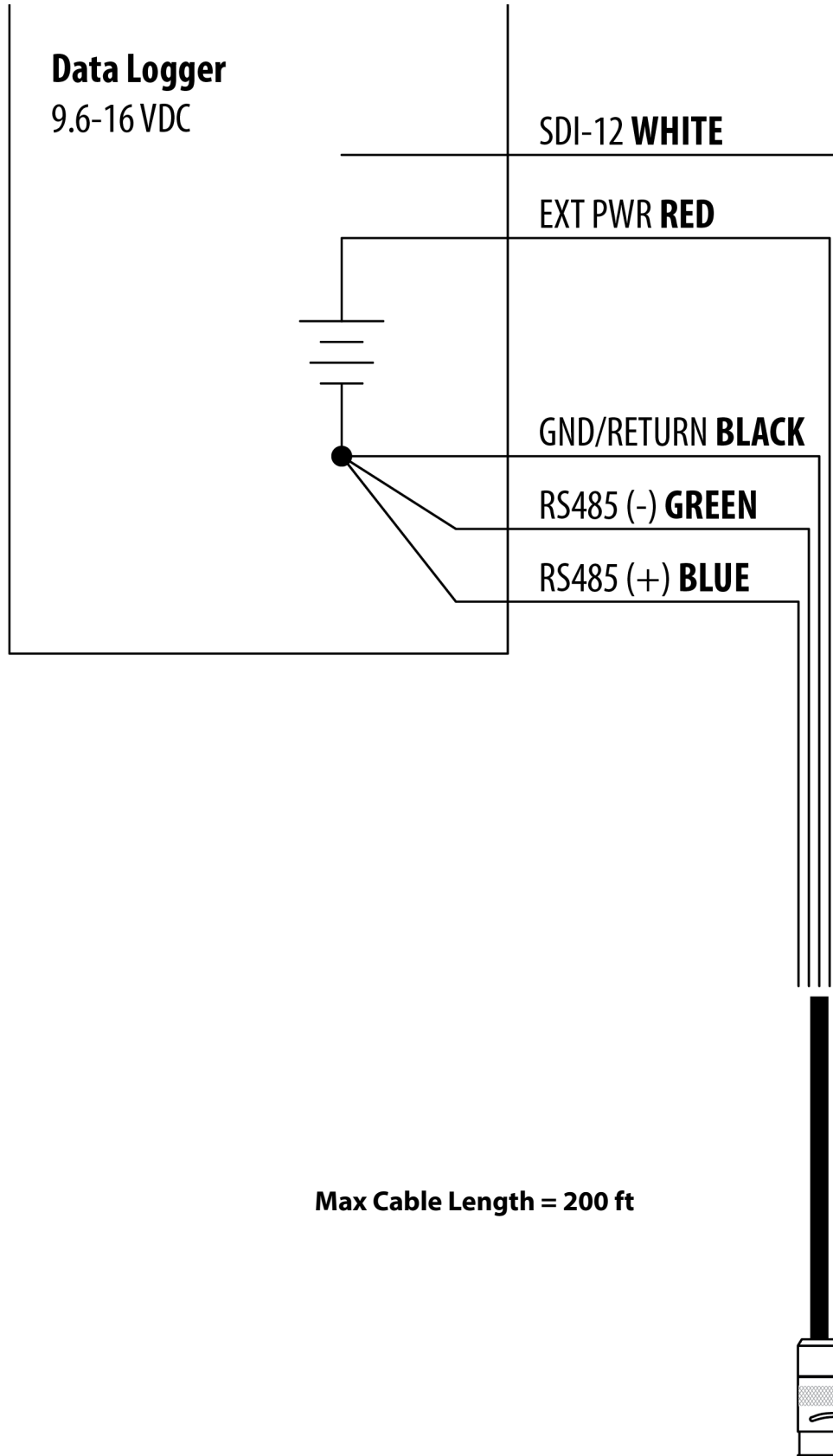

Modbus Master RS485

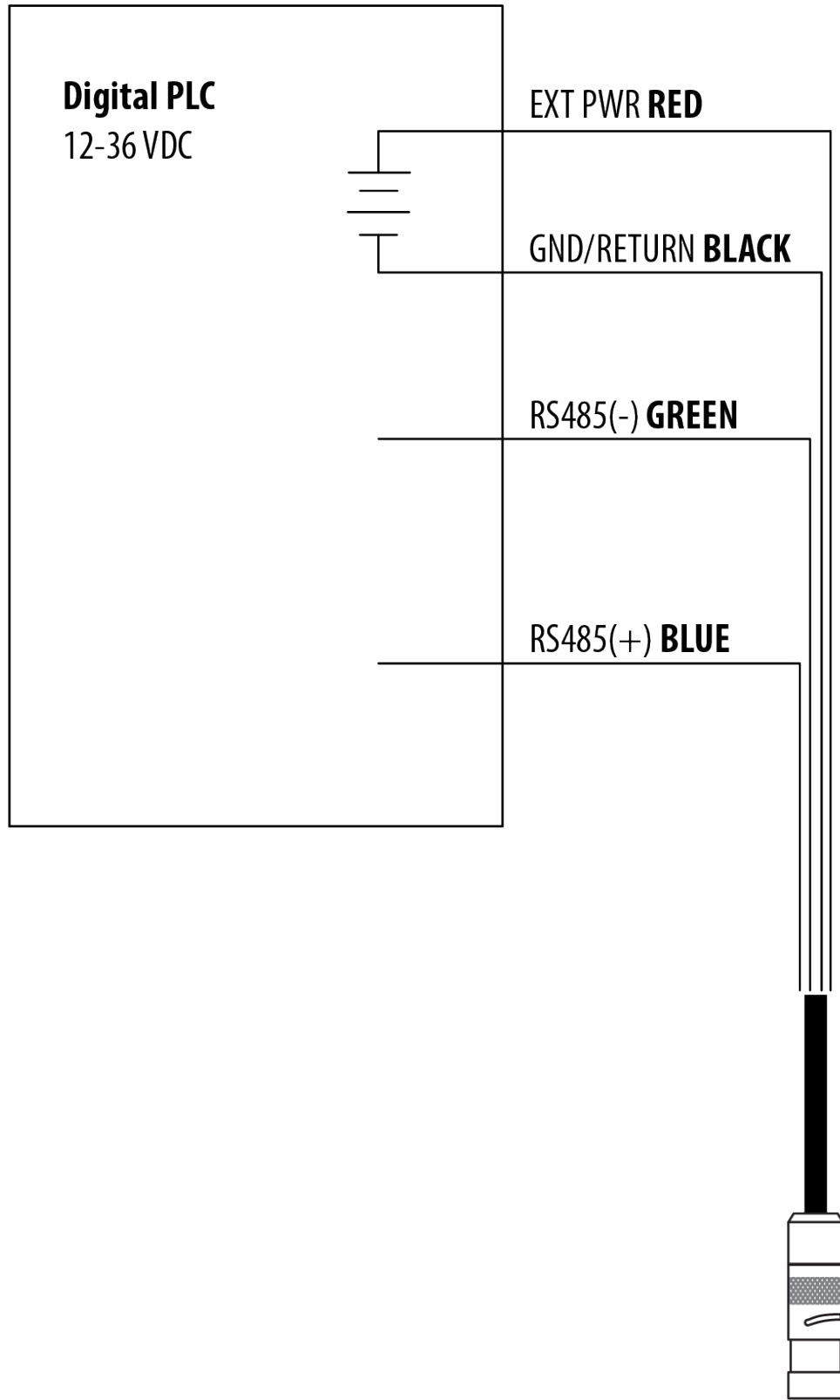

Modbus Master with RS232 (Converter Required)

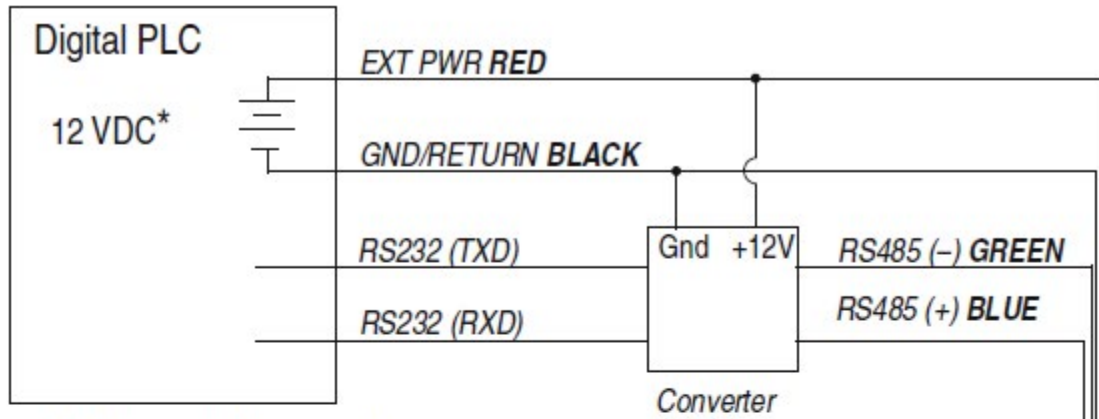

* Voltage limited by converter

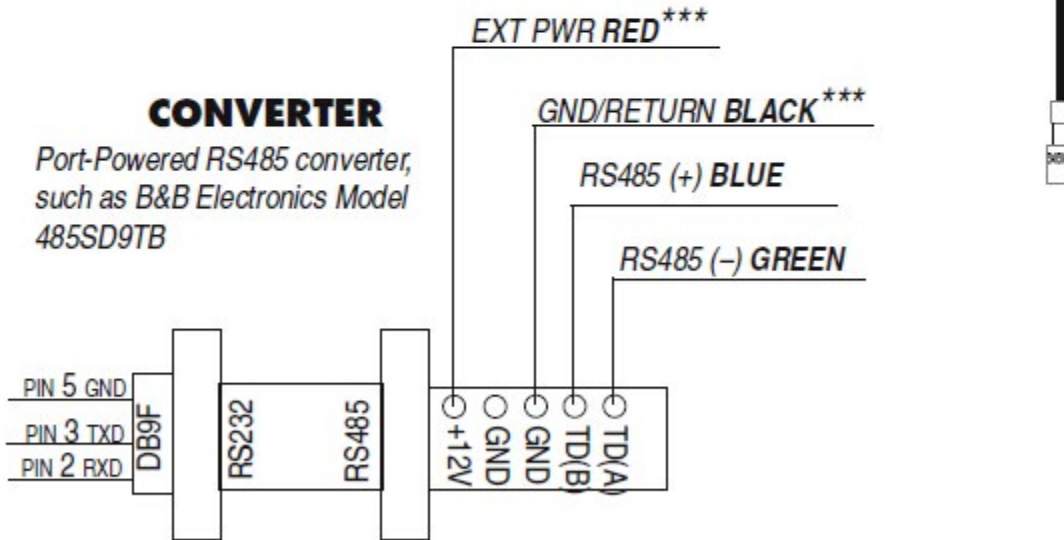

CONVERTER
 Port-Powered RS485 converter,
 such as B&B Electronics Model
 485SD9TB

***Required if port power is not available

Configuring SDI-12 Settings

About SDI-12

You can configure the list of SDI-12 parameters in VuSitu under **Instrument Settings**.

For information about the full SDI-12 capabilities of your sonde, see the Aqua TROLL 500/600 Interface Specification at www.in-situ.com/support/type/documentation.

Configure SDI-12 Settings in VuSitu

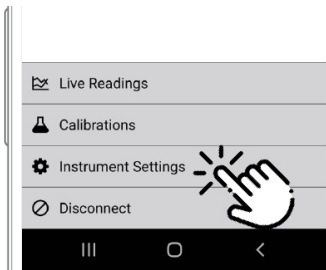

Connect to VuSitu and select **Instrument Settings**.

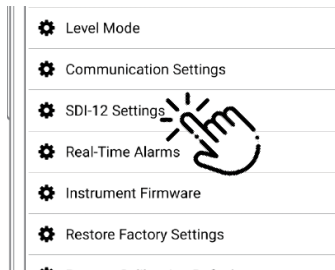

Choose **SDI-12 Settings**.

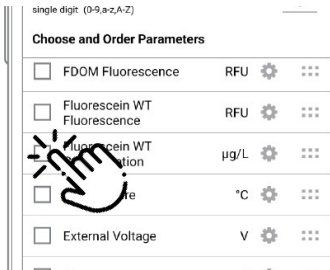

Use the checkboxes to select parameters to display.

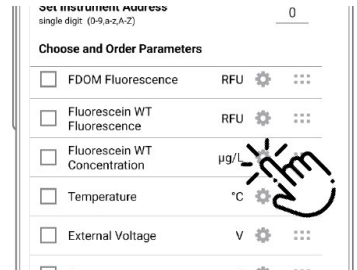

Tap the gear icon to adjust the units for each parameter.

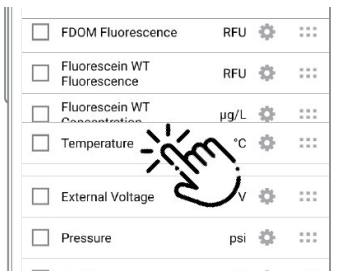

Drag and drop parameters to change the order.

Modbus PLC Interface

Overview

The Modbus PLC Interface is a simplified method of communicating with the Aqua TROLL 500 using the Modbus protocol. It reduces programming complexity and allows the user to remove sensors and reinstall them in different ports. Please observe the following limitations when using this interface:

- Only one sensor of any sensor model can be used in the sonde (for example: only one turbidity sensor can be installed).
- If a parameter is provided by more than one of the installed sensors, the interface will return the first value available.
- Firmware version 1.01 or later must be installed on the sonde.

For information about the specific Modbus registers and Unit IDs for your Aqua TROLL 500, see Appendices A and B. The Aqua TROLL 500 conforms to the Modbus standard. For more information about Modbus communication, see www.modbus.org.

Setting Up Instrument

1. Install the sensors and turn on the display by holding the instrument vertically.
 - a. Ensure the display turns on and check the LCD to ensure the sensors are working.
2. The setup below is using the instrument's factory default settings. Use WinSitu or VuSitu to reset the instrument to factory defaults if they have been changed.
 - a. Take note of any changes in default units setup.

Programming the PLC

1. Setup the serial communication the following values:

Mode	Start Bit	Baud Rate	Data Bits	Parity	Stop Bit
RTU	1	19200	8	Even	1

2. Set the device address to: 1
3. Set the PLC to wake-up the device by sending any Modbus command.
 - a. This could be a carriage return, reading the slave id or reading any register.
 - b. Allow several seconds before sending a second command. The instrument needs this time to wake up.
 - c. The instrument can take a reading once every two seconds.
4. Read the discovery register using Appendix A to trigger the instrument to scan the sensors.
 - a. The return value can be discarded.
 - b. Each register is a holding register. Some PLCs require you to add 40000 to the register number or address. For example: 9301 would be 49301.
 - c. Alternatively, you can prompt the instrument to discover its sensor mapping by connecting it to the VuSitu mobile app or Win-Situ software.
5. Select the register to read on the PLC using Appendix B
 - a. Some PLC devices use the register number directly in programming statements, others use register addresses, which are one less than the register number; the programmer must adhere to the PLC's programming style
 - b. Each register is a holding register. Some PLCs require you to add 40000 to the register number or address. For example: 5451 would be 45451.
6. Set the type of register to: 32-bit float
 - a. If asked by the PLC this is 2 registers
7. Set the byte order to: Big Endian (MSB)
 - a. This should be the default and may not be configurable on all PLCs

Reading Device Information

Use the following registers to read general information about the instrument.

Holding Register Number	Holding Register Address	Size (Registers)	Data Type	Description
9001	9000	1	uint16	Device Id: 33 = Aqua TROLL 500 Non-Vented 34 = Aqua TROLL 500 Vented
9002	9001	2	uint32	Serial Number
9007	9006	1	uint16	Firmware version (100 = 1.00)

Reading Parameters

Each parameter contains a block of 7 registers as shown in the table below. To read measurements for a specific parameter, look up the starting register for that parameter from the list of Parameter Numbers and Locations in Appendix A. Once you have the starting register, add the number of offset registers for additional information about the reading.

Register Offset	Size (Registers)	Mode (R/W)	Data Type	Description
0	2	R	float	The measured value from sensor
2	1	R	uint16	Data Quality ID: 0 = No errors or warnings 3 = Error reading parameter 5 = RDO Cap expired For additional errors or information, contact technical support.
3	1	R/W	uint16	Units ID for this parameter. See: Appendix B.
4	1	R	uint16	Parameter ID for this parameter. See: Appendix A.
5	2	R/W	float	Off line sentinel value: The value that's returned on error or if the parameter isn't available. The default sentinel is 0.0

For example, you can apply this information to collect a reading for Actual Conductivity.

From the list in Appendix A, you can find that the starting register for Actual Conductivity is 5507. A reading from register number 5507 (register address 5506) will return the measured value of Actual Conductivity.

Some PLC devices use the register number directly in programming statements, others use register addresses. Refer to PLC manufacturer instructions to determine which programming style to use.

You can use the register offsets listed in the table above to collect additional information about the reading. Adding the register offset of 2 to the starting register, you can find that register number 5509 (register address 5508) will return the Data Quality ID for the most recent Actual Conductivity measurement. Likewise, register number 5510 (register address 5509) will return the Units ID, which can be interpreted from Appendix B. Register number 5511 (register address 5510) will return the Parameter ID, which can be interpreted from Appendix A. Register number 5512 (register address 5511) will return the sentinel value.

The Units ID and Sentinel Value are writable registers. Measurements can be changed to other units using the Units ID as shown in Appendix B. For example, if register number 5510 (Actual Conductivity Units ID) returns 65, Actual Conductivity is configured to report in $\mu\text{S}/\text{cm}$. Looking at Appendix B, you can find that mS/cm is also a valid unit which can be set by writing Units ID 66 to register number 5510.

Care and Maintenance

Storage

Short-term (less than one week)



Remove the restrictor and the end cap.



Put the restrictor on the instrument in calibration mode.



Pour 15 mL (0.5 oz) of clean water into the restrictor and replace the cap.



Thread the restrictor onto the sonde and store.

Long-term (more than one week)



Remove pH/ORP and any ISE sensors.



Dampen the sponge inside the pH sensor storage cap with Storage Solution or pH 4 calibration standard.



Replace the caps at both ends of the sensor. Use electrical tape to seal the storage cap.



Thread the restrictor onto the sonde.



Store the sonde between -40 and 65° C. See the Instrument Specifications section for additional storage temperature requirements for pH/ORP and ISE sensors.

Cleaning the Sonde

Rinse the sonde thoroughly. Clean with warm water and mild soap, then rinse the sonde again. Air dry.



Prevent water from entering the cable connector.

Removing the Restrictor

If the restrictor or end cap are stuck and difficult to remove by hand, use strap wrenches to provide extra leverage. Remove the end cap bumper before using strap wrenches.



Never use pipe wrenches or a vise grip which may damage the instrument. Never insert tools into the restrictor holes for leverage, as they may damage the wiper shaft or sensors. Strap wrenches should only be used when necessary to remove or loosen parts. Tighten parts by hand only.

Maintenance Schedule



For best results, send the instrument and sensors for factory maintenance and calibration every 12 to 18 months.

User-Serviceable Parts



O-rings

Lubricate O-rings during initial setup. Check and replace O-rings if worn, damaged, or discolored.



Wiper Brush

Replace brush according to site needs when bristles are visibly bent, damaged, or fouled.



Bumpers

Replace bumpers and collar when they are visibly worn or damaged.



Sensors

See each sensor instruction sheets for details about maintaining and replacing each sensor.

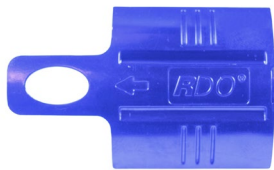

RDO Sensor Cap

Refer to the sensor cap instruction sheet for details.



Sensor Fill Solution

Refer to the instructions for the pH/ORP sensor and ISE sensors like Nitrate, Ammonium, and Chloride for details.



Reference Junction

Refer to the instructions for the pH/ORP sensor and ISE sensors like Nitrate, Ammonium, and Chloride for details.

Wiper Maintenance



Replace brush according to site needs when bristles are visibly bent, damaged, or fouled.

Replace wiper brush.



Loosen brush housing with hex key.



Slide the old brush off of the wiper shaft.



Slide the new brush onto the wiper shaft.



Tighten brush screw with hex key.

Cleaning and Storing the pH/ORP Sensor and Ion-Selective Electrode (ISE) sensors

Storage



Dampen the sponge inside the sensor storage cap with Storage Solution or pH 4 calibration standard.



Replace the caps at both ends of the sensor. Use electrical tape to seal the storage cap.



Do not store the pH/ORP sensor or ISE sensors in DI water. It will deplete the reference solution and drastically reduce the life of the sensor.

Routine Maintenance

If the ORP platinum electrode is dull or dirty, it can be cleaned with a swab and methanol or isopropyl alcohol. Rub the electrode gently until it is shiny. The pH sensor must be kept moist for the life of the sensor. The sensor fill solution has a shelf life of 2 years. Replace the fill solution every 5 to 6 months or when:

1. The sensor fails to calibrate within the acceptable slope and offset range.
2. Sensor readings vary or are slow to respond.
3. Readings during calibration at pH 7 are greater than +30 mV or less than -30 mV.

Replacing the Filling Solution



Remove sensor from sonde and unscrew reference junction.



Discard old solution onto a paper towel and throw it in the trash. Do not discard down the drain.



Insert tube from filling solution bottle into sensor.



Squeeze solution into reservoir until full. Slowly remove tube.



Reinstall reference junction. Dry sensor body.

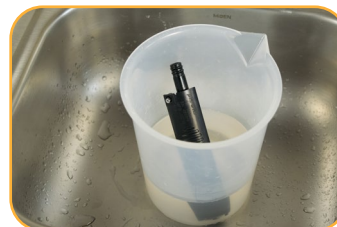

Soak ISE sensors for 2 hours in the highest concentration calibration standard you plan to use.



Rinse the sensor thoroughly prior to calibration.

Replacing the Junction



If the sensor fails to calibrate after you replace the fill solution, replace the reference junction.



Remove sensor from sonde and unscrew reference junction.



Discard old solution onto a paper towel and throw it in the trash. Do not discard down the drain.



Insert tube from filling solution bottle into sensor.



Squeeze solution into reservoir until full. Slowly remove tube.



Reinstall reference junction and wipe sensor body dry.



Soak ISE sensors for 2 hours in the highest concentration calibration standard you plan to use.



Rinse the sensor thoroughly prior to calibration.



Keep the reference junction damp at all times.

Cleaning

Begin with the gentlest cleaning method and continue to the others only if necessary. Do not directly wipe the glass bulb. To clean the pH sensor, gently rinse with cold water. If further cleaning is required, consider the nature of the debris.

To remove crystalline deposits:

1. Clean the sensor with warm water and mild soap.
2. Soak the sensor in 5% HCl solution for 10 to 30 minutes.
3. If deposits persist, alternate soaking in 5% HCl and 5% NaOH solutions.

To remove oily or greasy residue:

1. Clean the sensor with warm water and mild soap.
2. Methanol or isopropyl alcohol may be used for short soaking periods, up to 1 hour.
3. Do not soak the sensor in strong solvents, such as chlorinated solvents, ethers, or ketones, such as acetone.

To remove protein-like material, or slimy film:

1. Clean the sensor with warm water and mild soap.
2. Soak the sensor in 0.1 M HCl solution for 10 minutes and then rinse with deionized water.

Cleaning and Storing the RDO Sensor

Routine Maintenance

1. Leave the sensor cap on.
2. Rinse the sensor with clean water.
3. Gently wipe with a soft cloth or brush if biofouling is present.
4. If extensive fouling or mineral buildup is present, soak the sensor in vinegar for 15 minutes, then soak in deionized water for 15 minutes.



Do not use organic solvents—they will damage the sensor cap. Do not remove the sensor cap when rinsing or brushing.

5. After cleaning the sensor, perform a 100% Saturation calibration.

Cleaning the Optical Window

Clean the optical window only when changing the sensor cap.

1. Remove the cap.
2. Gently wipe the sensing window with the supplied lens cloth.



Do not wet the lens with any liquid.

Storage

Prior to installation, store the sensor body and cap in the factory supplied containers.

Once installed on the sonde, the RDO sensor can be stored wet or dry depending on the sensor configuration of the sonde.



Never store the RDO sensor without the sensor cap once it has been installed on the sonde.

Cleaning and Storing the Turbidity Sensor

Routine Maintenance

The optical windows should be clear of foreign material. To clear material gently rub the sensing windows using clean water and a soft cloth or swab. Do not use solvents on the sensor.

Storage

Prior to installation, store the sensor in the factory supplied container. Once installed on the sonde, the turbidity sensor can be stored wet or dry depending on the sensor configuration of the sonde.

Cleaning and Storing the Conductivity Sensor



Soaking the sensor in vinegar for longer than one hour can cause serious damage.

Begin with the most gentle cleaning method and continue to the other methods only if necessary. To clean the conductivity sensor face, gently rinse with clean, cold water. If further cleaning is required, consider the nature of the debris.

To remove crystalline deposits:

1. Clean the sensor face with warm water and mild soap.
2. Use a soft brush to gently clean the sensor pins and temperature button. Ensure removal of all debris around the base of the pins and button.
3. If crystalline deposits persist, soak in 5% HCl for 10 to 30 minutes followed by warm soapy water and soft brushing.
4. If deposits persist, alternate soaking in 5% HCl and 5% NaOH solutions followed by warm soapy water and soft brushing.

To remove oily or greasy residue:

- Clean the sensor face with warm water and mild soap.
- Using a soft brush, gently clean the sensor pins and temperature button. Ensure removal of all residue around the base of the pins and temperature button.
- Isopropyl alcohol may be used for short soaking periods, up to one hour.
- Do not soak in strong solvents such as chlorinated solvents, ethers or ketones (such as acetone).

To remove protein-like material, or slimy film:

- Clean the sensor face with warm water and mild soap.
- Using a soft brush, gently clean the sensor pins and temperature button. Ensure removal of all material/film around the base of the pins and temperature button.
- Soak the sensor in 0.10% HCl for 10 minutes and then rinse thoroughly with distilled water.

Storage

Prior to installation, store the sensor in the factory supplied container.

Once installed on the sonde, the Temperature Sensor and Conductivity Sensor can be stored wet or dry depending on the sensor configuration of the sonde.

Cleaning the Copper Antifouling Restrictor

When copper is deployed in environmental waters, particularly marine environments, the copper will oxidize and its biocidal properties decrease. Cleaning the copper restores the effectiveness of the restrictor's antifouling capability.

1. Remove the restrictor from the sonde.
2. Remove the restrictor end cap.
3. Submerge the restrictor in white vinegar (acetic acid) for 24 hours.
4. Rinse the restrictor in water and air dry.

Service and Repair

Obtaining Repair Service

If you suspect your system is malfunctioning and repair is needed, you can help assure efficient servicing by following these guidelines:

1. Call or email In-Situ Technical Support. Have the product model and serial number available.
2. Be prepared to describe the problem, including how the product was used and the conditions noted at the time of the malfunction.
3. If Technical Support determines that service is needed, they will ask your company to fill out the RMA form and pre-approve a specified monetary amount for repair charges. When the form and pre-approval is received, Technical Support will assign an RMA (Return Material Authorization) number.
4. Clean the product as described in the manual.
5. If the product contains a removable battery, remove and retain it unless you are returning the system for a refund or Technical Support states otherwise.
6. Carefully pack your product in its original shipping box, if possible.
7. Mark the RMA number clearly on the outside of the box.
8. Send the package, shipping prepaid, to:

In-Situ:

ATTN: Repairs

221 East Lincoln Avenue

Fort Collins, CO 80524

The warranty does not cover damage during transit. In-Situ recommends insurance for all shipments. Warranty repairs will be shipped back prepaid.

Outside the U.S.

Contact your international In-Situ distributor for repair and service information.

Guidelines for Cleaning Returned Equipment

Please help us protect the health and safety of our employees by cleaning and decontaminating equipment that has been subjected to potential biological or health hazards, and labeling such equipment. Unfortunately, we cannot service your equipment without such notification. Please complete and sign the form (or a similar statement certifying that the equipment has been cleaned and decontaminated) and send it to us with each instrument.

1. We recommend cleaning with only mild soaps that are compatible with the product materials. Wetted materials lists are provided on the product specification sheets. Clean all cables and remove all foreign matter.
2. Clean the cable connectors with a clean, dry cloth. Do not submerge the connectors.
3. Clean the instrument including the restrictor, sensor faces, and sonde body.



If an instrument is returned to our Service Center for repair or recalibration without a statement that it has been cleaned and decontaminated, or if it is the opinion of our Service Representatives that the equipment presents a potential health or biological hazard, we reserve the right to withhold service until proper certification is obtained.

Decontamination & Cleaning Statement



Company Name	Phone
Address	
City	State
Instrument Type	Serial Number
Contaminant(s) if known	
Decontamination procedure(s) used	
Cleaning verified by	Title
Date	

More Information



To learn more about the Aqua TROLL 500, telemetry, software and other In-Situ products, see the resources listed below.

1 Visit www.in-situ.com

Find information about In-Situ water quality, water level, telemetry and other products. Download software, manuals and product instructions.

2 View the [In-Situ YouTube channel](#).

Get video instructions for the Aqua TROLL 500 and other instruments. Watch quickstart videos and other tutorials.

3 Call [In-Situ's technical support team](#).

For further instructions and help with technical questions, call the In-Situ support line at 1-970-498-1500.



CE Declaration of Similarity

Manufacturer: In-Situ, Inc.
221 East Lincoln Avenue, Fort Collins, CO 80524, USA

Declares that performance of each of the following products is equivalent to the Aqua TROLL 600:
Product name: **Aqua TROLL® 500 Multiparameter Sonde and ChemScan MPX4 Multiparameter Sonde**
Model: **Aqua TROLL® 500 and ChemScan MPX4**
Part Number: **005070, 0050710, 0050720, 0050730, 0050740, 0050750, 0050760, 0050770, 0050780, 005090, 230480**
Product Description: **Multiparameter water quality data logger**
Model Variants: The Aqua TROLL 500 is available as No Pressure sensor, Non-Vented and Vented variants. The non-vented and vented variants are available in four different pressure ranges: 0-9m, 0-30m 0-76m and 0-200m.

These are in compliance with the following Directive

- Radio Equipment Directive (RED), 2014/53/EU
- Restriction of the use of certain hazardous substances in electrical and electronic equipment (RoHS) Directive, 2011/65/EU and Commission Delegated Directive, (EU) 2015/863

and meet or exceed the following international requirements and compliance standards:

Radio Equipment Directive Article 3.1(a) Safety Standards:
IEC61010-1:2010 + A1:2019

Radio Equipment Directive Article 3.1(b) EMC Standards:
ETSI EN 301 489-1 V2.2.3
ETSI EN 301 489-17 V3.1.1

Radio Equipment Directive Article 3.2 Radio Standards:
EN 300 328 V2.2.2
EN 62311:2019

RoHS Standard:
EN 50581:2012

The CE mark is affixed accordingly.

Ben Kimbell
VP of R&D
In-Situ, Inc.
April 5, 2021





UKCA Declaration of Similarity

Manufacturer: In-Situ, Inc.
221 East Lincoln Avenue, Fort Collins, CO 80524, USA

We declare that the performance of each of the following products is equivalent to the Aqua TROLL 600:
Product name: **Aqua TROLL® 500 Multiparameter Sonde and ChemScan MPX4 Multiparameter Sonde**
Model: **Aqua TROLL® 500 and ChemScan MPX4**

Part Number: **005070, 0050710, 0050720, 0050730, 0050740, 0050750, 0050760, 0050770, 0050780, 005090, 230480**

Product Description: **Multiparameter water quality data logger**

Model Variants: The Aqua TROLL 500 is available as No Pressure sensor, Non-Vented and Vented variants. The non-vented and vented variants are available in four different pressure ranges: 0-9m, 0-30m 0-76m and 0-200m.

These products are in compliance with the following Regulations:

- Radio Equipment Regulation 2017 (S.I. 2016:1206)
- Restriction of the use of certain hazardous substances in electrical and electronic equipment (RoHS) Regulation (S.I. 2012:3032)
- Electrical Equipment (Safety) Regulation 2016 (S.I. 2016:1101)

and meet or exceed the following British requirements and compliance standards:

- **Safety:** BS 61010-1:2010 + AMD 1:2019
- **Immunity:** BS EN 61000-6-2:2019
- **Emissions:** BS EN 55024:2010 + A1:2015

The UKCA mark is affixed accordingly.

Ben Kimbell
VP of R&D
In-Situ, Inc.
February 23, 2022



Appendix

Appendix A: Parameter Numbers and Locations

ID	Parameter Name	Holding Register Number	Holding Register Address	Default Units
1	Temperature	5451	5450	1 = °C
2	Pressure	5458	5457	17 = PSI
3	Depth	5465	5464	38 = feet
4	Level, Depth to Water	5472	5471	38 = feet
5	Level, Surface Elevation	5479	5478	38 = feet
9	Actual Conductivity	5507	5506	65 = $\mu\text{S}/\text{cm}$
10	Specific Conductivity	5514	5513	65 = $\mu\text{S}/\text{cm}$
11	Resistivity	5521	5520	81 = ohm-cm
12	Salinity	5528	5527	97 = PSU
13	Total Dissolved Solids	5535	5534	114 = ppt
14	Density of Water	5542	5541	129 = g/cm^3
16	Barometric Pressure	5556	5555	22 = mmHg
17	pH	5563	5562	145 = pH
18	pH mV	5570	5569	162 = mV
19	ORP	5577	5576	162 = mV
20	Dissolved Oxygen Concentration	5584	5583	117 = mg/L
21	Dissolved Oxygen % Saturation	5591	5590	177 = % Saturation
24	Chloride (Cl)	5612	5611	117 = mg/L
25	Turbidity	5619	5618	194 = NTU
30	Oxygen Partial Pressure	5654	5653	26 = torr

ID	Parameter Name	Holding Register Number	Holding Register Address	Default Units
31	Total Suspended Solids	5661	5660	117 = mg/L
32	External Voltage	5668	5667	163 = Volts
33	Battery Capacity (remaining)	5675	5674	241 = %
34	Rhodamine WT Concentration	5682	5681	118 = µg/L
35	Rhodamine WT Fluorescence Intensity	5689	5688	257 = RFU
36	Chloride (Cl ⁻) mV	5696	5695	162 = mV
37	Nitrate as Nitrogen (NO ₃ ⁻ -N) concentration	5703	5702	117 = mg/L
38	Nitrate (NO ₃ ⁻) mV	5710	5709	162 = mV
39	Ammonium as Nitrogen (NH ₄ ⁺ -N) concentration	5717	5716	117 = mg/L
40	Ammonium (NH ₄) mV	5724	5723	162 = mV
41	Ammonia as Nitrogen (NH ₃ -N) concentration	5731	5730	117 = mg/L
42	Total Ammonia as Nitrogen (NH ₃ -N) concentration	5738	5737	117 = mg/L
48	Eh	5780	5779	162 = mV
49	Velocity	5787	5786	118 = µg/L
50	Chlorophyll-a Concentration	5794	5793	118 = µg/L
51	Chlorophyll-a Fluorescence Intensity	5801	5800	257 = RFU
54	Blue Green Algae-Phycocyanin Concentration	5822	5821	118 = µg/L
55	Blue Green Algae-Phycocyanin Fluorescence Intensity	5829	5828	257 = RFU
58	Blue Green Algae-Phycoerythrin Concentration	5850	5849	118 = µg/L
59	Blue Green Algae-Phycoerythrin Fluorescence Intensity	5857	5856	257 = RFU
67	Fluorescein WT Concentration	5913	5912	118 = µg/L

ID	Parameter Name	Holding Register Number	Holding Register Address	Default Units
68	Fluorescein WT Fluorescence Intensity	5920	5919	257 = RFU
69	Fluorescent Dissolved Organic Matter Concentration	5927	5926	118 = µg/L
70	Fluorescent Dissolved Organic Matter Fluorescence Intensity	5934	5933	257 = RFU
80	Crude Oil Concentration	6004	6003	118 = µg/L
81	Crude Oil Fluorescence Intensity	6011	6010	257 = RFU
87	Colored Dissolved Organic Matter Concentration	6053	6052	118 = µg/L

Appendix B: Unit IDs

ID	Abbreviation	Units
1	C	Celsius
2	F	Fahrenheit
3	K	Kelvin
Pressure, Barometric Pressure (17-32)		
17	PSI	Pounds per square inch
18	Pa	Pascals
19	kPa	Kilopascals
20	Bar	Bars
21	mBar	Millibars
22	mmHg	Millimeters of Mercury (0 to C)
23	inHg	Inches of Mercury (4 to C)
24	cmH ₂ O	Centimeters of water (4 to C)
25	inH ₂ O	Inches of water (4 to C)
26	Torr	Torr
27	atm	Standard atmosphere
Distance/Length (33-48)		
33	mm	Millimeters
34	cm	Centimeters
35	m	Meters
36	km	Kilometer
37	in	Inches
38	ft	Feet
Coordinates (49-64)		
49	deg	Degrees
50	min	Minutes
51	sec	Seconds

Conductivity (65-80)		
65	μS/cm	Microsiemens per centimeter
66	mS/cm	Millisiemens per centimeter
Resistivity (81-96)		
81	ohm-cm	Ohm-centimeters
Salinity (97-112)		
97	PSU	Practical Salinity Units
98	ppt	Parts per thousand salinity
Concentration		
113	ppm	Parts per million
114	ppt	Parts per thousand
115		(Available)
116		(Available)
117	mg/L	Milligrams per liter
118	μg/L	Micrograms per liter
119	---	(Deprecated)
120	g/L	Grams per liter
121	ppb	Parts per billion
Density (129-144)		
129	g/cm ³	Grams per cubic centimeter
pH (145-160)		
145	pH	pH
Voltage (161-176)		
161	μV	Microvolts
162	mV	Millivolts
163	V	Volts
Dissolved Oxygen (DO) % Saturation (177-192)		
177	% sat	Percent saturation
Turbidity (193-208)		
193	FNU	Formazin nephelometric units
194	NTU	Nephelometric turbidity units
195	FTU	Formazin turbidity units

Flow (209-224)

209	ft ³ /s	Cubic feet per second
210		(Available - was Cubic feet per minute)
211		(Available - was Cubic feet per hour)
212	ft ³ /day	Cubic feet per day
213	gal/s	Gallons per second
214	gal/min	Gallons per minute
215	gal/hr	Gallons per hour
216	MGD	Millions of gallons per day
217	m ³ /sec	Cubic meters per second
218		(Available - was Cubic meters per minute)
219	m ³ /hr	Cubic meters per hour
220		(Available - was Cubic meters per day)
221	L/s	Liters per second
222	ML/day	Millions of liters per day
223	mL/min	Milliliters per minute
224	kL/day	Thousands of liters per day

Volume (225-240)

225	ft ³	Cubic feet
226	gal	Gallons
227	Mgal	Millions of gallons
228	m ³	Cubic meters
229	L	Liters
230	acre-ft	Acre feet

231	mL	Milliliters
232	ML	Millions of liters
233	kL	Thousands of liters
234	Acre-in	Acre inches
% (241-256)		
241	%	Percent
Fluorescence (257-2720)		
257	RFU	Relative Fluorescence Units
Low-Flow (273-288)		
273	mL/sec	Milliliters per second
274	mL/hr	Milliliters per hour
275	L/min	Liters per minute
276	L/hr	Liters per hour
Current (289-304)		
289	μ A	Microamps
290	mA	Milliamps
291	A	Amps
Velocity (305-320)		
305	ft/s	Feet per second
306	m/s	Meters per second