

Geotech Bladder Pumps

Installation and Operation Manual



Table of Contents

DOCUMENTATION CONVENTIONS	2
Section 1: System Description	2
Function and Theory	3
System Components.....	4
Pump Housing	4
Air and Sample Line Connections.....	4
Bladder assembly	4
Section 2: System Installation	6
Pump Tubing Lines	6
Compression Fitting Installation	6
Safety Cable	7
Optional Drop Tube Assembly	8
Section 3: System Operation Bladder Pump Operation	9
Selecting an Air Source.....	9
Air Volume of Tubing.....	9
Air Volume of Bladder Pumps.....	9
Determining Operation Pressure.....	10
Flow Rates	10
Section 4: System Maintenance Bladder Pump	12
Replacing the Bladder.....	12
<i>1.66" Models</i>	12
<i>Reassemble the 1.66" Models:</i>	13
Compression Fittings.....	19
Section 5: System Troubleshooting	20
Section 6: System Specifications	21
Section 7: Replacement Parts List	22
1.66 Bladder Pump Components (36" & 18" LOW Pressure Models).....	22
1.66 Bladder Pump Components (36" & 18" HIGH Pressure Models).....	25
.850 Stainless Steel Bladder Pump Components.....	28
.675 Stainless Steel Bladder Pump Components.....	30
The Warranty	33

DOCUMENTATION CONVENTIONS

This document uses the following conventions to present information:



An exclamation point icon indicates a **WARNING** of a situation or condition that could lead to personal injury or death. You should not proceed until you read and thoroughly understand the **WARNING** message.

WARNING



A raised hand icon indicates **CAUTION** information that relates to a situation or condition that could lead to equipment malfunction or damage. You should not proceed until you read and thoroughly understand the **CAUTION** message.

CAUTION



A note icon indicates **NOTE** information. Notes provide additional or supplementary information about an activity or concept.

NOTE

Section 1: System Description

Function and Theory

Geotech's pneumatic Bladder Pumps operate with a unique air-driven action, ideal for both gentle low-flow sampling and high-flow rate purging. Timed ON/OFF cycles of compressed air alternately squeeze the flexible bladder to displace water out of the pump to the surface then exhaust the air allowing the pump to refill.

Fluid enters and fills the pump through the fluid inlet check valve at the bottom of the pump body via hydrostatic pressure. Once filled with fluid, compressed air enters the space between the bladder and the interior of the pump housing, squeezes the bladder, and pushes the fluid to the surface (see Figure 1-1). Operated by the BP Controller or Geocontrol PRO, this logic automatically repeats.

Air does not contact the sample. The bladder prevents contact between the pump driven air and the sample. All wetted pump parts are 316 Grade stainless steel to ensure the purity of the sample is maintained.

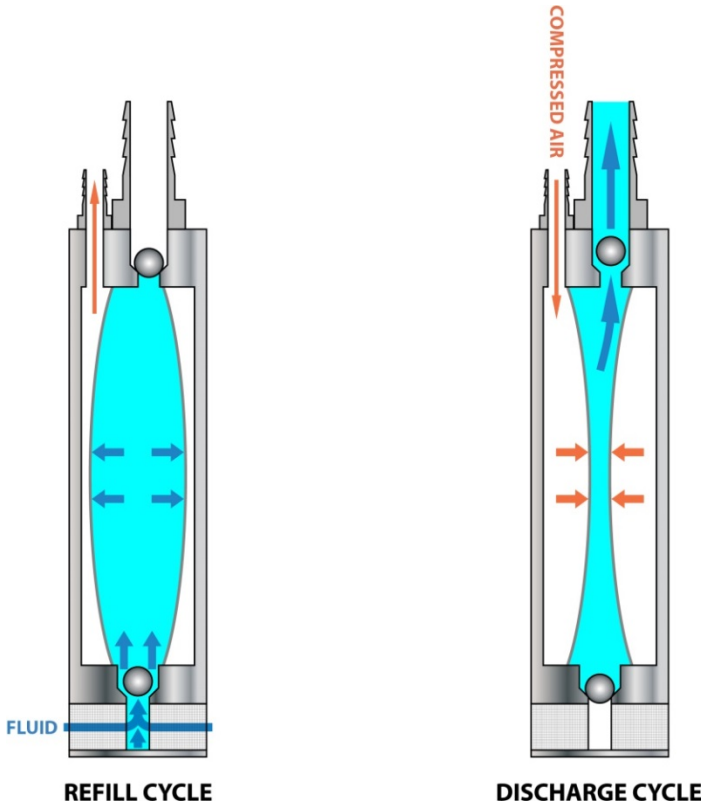

Figure 1-1: Bladder Pump Operation
Not to scale



Be sure to read and understand your portable generator and/or portable air compressor user manual for proper installation, operation, and Earth grounding instructions. If using portable compressed gas tanks, exercise caution, use safety protection devices as outlined by the supplier, and observe any additional safety requirements mandated by local jurisdiction.

System Components

The Geotech Bladder Pump features four accessible parts (see Figure 1-2):

- Intake Screen
 - Pump Housing
 - Air and Sample Line Connections
 - Bladder Assembly
- *Optional: Drop Tube Intake Assembly

Intake Screen

The intake filter screen is constructed of 316 Stainless Steel and is easily removed and disassembled for field maintenance. The intake filter screen is intended to protect and extend the life of the bladder material (see *The Warranty*).

Pump Housing

The Geotech Bladder Pump housing is constructed of electropolished 316 Stainless Steel. Viton O-rings provide the high-pressure seals between the end caps and the housing walls. Always lubricate the O-rings with deionized water before installing the housing and intake screen.

Air and Sample Line Connections

The 1.66" Bladder Pump is provided in both low and high-pressure configurations. The low-pressure model is equipped with hose barbs for air and sample line connections, whereas the high-pressure model is equipped with heavy-duty compression fittings. The .850" and .675" models are both considered low pressure. See *Section 6: System Specifications* for operating depths and pressures.

Bladder assembly

The bladders are extruded Polyethylene (PE) or Polytetrafluoroethylene (PTFE) to provide a long life and to ensure undisturbed samples. The internal bladders are easily replaceable, see *Section 4: System Maintenance*.

Drop Tube Intake Assembly (Optional)

An optional drop tube can be used to sample from depths below the specified maximum sampling depth. The drop tube assembly connects a remote intake feature to the pump through a tube connected to the pump inlet. The intake depth can be any custom length of tubing. The pump assembly itself must still be submerged below the water level. This means the depth to water cannot exceed the maximum pumping depth of the pump.

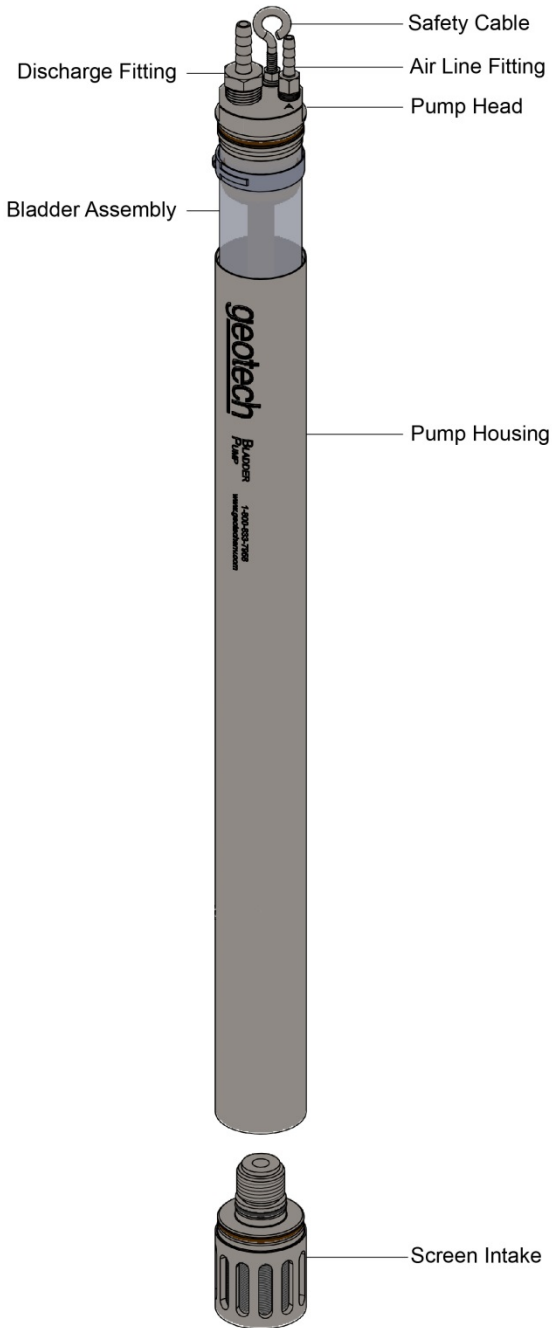

Figure 1-2: Basic* Bladder Pump Assembly

**Example above is based on 1.66" Low Pressure configuration*

Section 2: System Installation

Determine site-specific parameters such as water level, recharge rate and adherence to low flow purging guidelines. Speak with your Geotech Customer Service Representative to ensure the right equipment is being used.

Pump Controller

Geotech Bladder Pumps can be operated using a variety of controllers. Site requirements will determine the optimal control unit. Use the table below as a guide:

Controller	Air Source	Max Operating Depth
Geocontrol Pro	Internal compressor	180' (55m)
BP Controller 300 PSI	Externally supplied	690' (210m)
BP Controller 500 PSI	Externally supplied	1000' (305m)

Pump Tubing Lines

Geotech's Bladder Pumps are engineered for easy installation and use. Dedicated Bladder Pump systems are available with the tubing and well cap attached for ease of deployment. Well identifications (supplied by customer) are located on tags connected to the tubing, and on the tubing bags.

If not pre-attached, at the wellhead connect the airline tubing to air line connection at the top of the Bladder Pump (see Figure 1-2). The letter "A" has been stamped near the airline port on the top of each pump. See *Section 6: System Specifications* for air line system sizes.

Next, attach the discharge line to the discharge line connection at the top of pump (see Figure 1-2).



Failure to attach air and fluid lines to the appropriate ports could result in damage to the bladder.

Compression Fitting Installation

1. Ensure tubing is cut at a square, 90° angle.
2. Attach nut, back ferrule, and front ferrule to the tubing.
3. Ensure the front of the ferrule is touching the inlet, then slide the nut over the ferrule and tighten it finger-tight.
4. Mark the nut with a line.
 - This line will indicate the initial start point of the nut.
5. Hold the fitting body steady with a wrench. Turn the nut 1 ¼ turns.
 - Do not overtighten.
 - If re-installing compression fitting after repair/regular maintenance, turn the nut 1 turn after hand-tightening.

Safety Cable

Before deploying any sampling pump, secure a safety cable from an anchoring point at or near the wellhead to the top of the pump.

Carefully lower the Bladder Pump into the well using the Reverse Coil Method to avoid kinking, until the desired depth is achieved or until the well cap seats Reverse Coil Method

When lowering the pump into the well, it is important to reverse the natural bend of the coiled tubing so that the tubing straightens as it is lowered (see Figure 2-1). As the pump and tubing are lowered into the well, the direction of the bend should be reversed from the direction in which it is coiled. If the tubing is allowed to uncoil naturally and the natural bend not interrupted, the tubing will continue its coil into the well. Using the reverse coil method will avoid any difficulty while lowering the pump into the well, especially when the well is not completely vertical, or has come out of alignment for any reason.

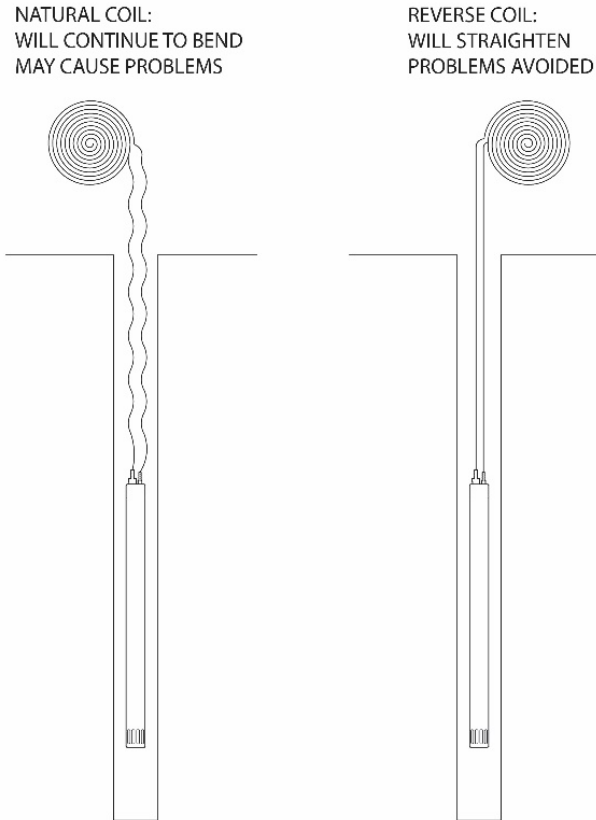

Figure 2-1: Reverse Coil Method

Optional Drop Tube Assembly

If a Drop Tube Intake Assembly is employed, a third tubing line is necessary to connect from the bottom of the bladder pump to the top of the drop tube intake.

For deployment of optional Drop Tube Intake Assembly, attach desired length of drop tube between the intake's hose barb and hose barb on bottom of pump. For added security, a safety cable may be installed to support the drop tube intake to the bottom of pump.

Send the drop tube intake down the well followed by the drop tube tubing, then the pump, and finally the air and fluid discharge line.

Section 3: System Operation

Bladder Pump Operation

Fluid enters the pump through the fluid inlet check valve at the bottom of the pump body via hydrostatic pressure. The pump MUST be submerged to operate. The bladder then fills with fluid. Compressed air enters the space between the bladder and the interior of the pump housing. The intake check valve closes and the discharge check valve (top) opens. Compressed air squeezes the bladder, pushing the fluid to the surface. The discharge check valve prevents back flow from the discharge tubing.

Selecting an Air Source

Air consumption depends on the volume of tubing and the size of deployed Bladder Pump. Follow the general guidelines and examples below to calculate the air consumption for specific sampling configurations.

Air Volume of Tubing

TUBE I.D.	TUBING LENGTH					
	1 ft/ 0.3 m	10 ft/ 3 m	50 ft/ 15 m	100 ft/ 30 m	250 ft/ 76 m	500 ft/ 152 m
0.17 in/ 0.43 cm	0.3 in ³ / 5 cm ³	3 in ³ / 50 cm ³	15 in ³ / 246 cm ³	30 in ³ / 492 cm ³	75 in ³ / 1230 cm ³	150 in ³ / 2460 cm ³
0.25 in/ 0.64 cm	0.6 in ³ / 10 cm ³	6 in ³ / 100 cm ³	30 in ³ / 492 cm ³	60 in ³ / 984 cm ³	150 in ³ / 2460 cm ³	300 in ³ / 4920 cm ³

Air Volume of Bladder Pumps

BP DIAMETER	BP LENGTH	VOLUME (in ³)
1.66 in/ 4 cm	36 in/ 91 cm	78 in ³ / 1278 cm ³
1.66 in/ 4 cm	18 in/ 46 cm	39 in ³ / 640 cm ³
0.85 in/ 4 cm	18 in/ 46 cm	10 in ³ / 164 cm ³
0.675 in/ 4 cm	18 in/ 46 cm	6 in ³ / 100 cm ³

Calculation guideline:

Volume of Tubing (in³/cm³)

+ Volume of Bladder Pump (in³/ cm³)

= Air Consumption per cycle (in³/ cm³)

If planning to use an air compressor, use one with a reserve tank to insure proper air supply to the pump. If using a Nitrogen Tank, see Figure 3-1 for Nitrogen Tank Volume vs. Bladder Pump consumption.

Determining Operation Pressure

Determine the air pressure needed to operate the Bladder Pump based on the length of the air supply line to the pump (well depth).

Use the simplified formula:

$$0.5 \text{ PSI (per foot)} + 10 \text{ PSI (to account for tubing friction)} = \text{required PSI}$$

$$0.12 \text{ bar (per meter)} + 0.7 \text{ bar (to account for tubing friction)} = \text{required bar}$$

As mentioned above, the additional 10 PSI (0.7 bar) is to account for the pump itself and friction loss along the air line tubing. When the length of the airline is 50' (15m) or less, there is no need for the additional pressure.

To determine minimum operating pressures for the specific Bladder Pump model you are using, consult the pump's specifications. Typically, the minimum operating pressure will be 5 PSI (0.4 bar) above static head.



The formulas stated above are not absolute, and are meant to provide baseline information.

Flow Rates

Bladder Pump flow rates are influenced by pump size (diameter and length); pump depth and submergence, as well as controller selection (i.e. compressor performance, valve flow coefficient). Generally, a large pump at shallow depths will produce the most flow, and a small pump at maximum depths will produce the least amount of flow.

Example flow rates:

Pump Size:	Depth: (3ft (0.9m) submergence)	Tubing Size		Flow Rate:
		Air line:	Discharge:	
1.66 x 36"	@ 275 ft (84 m)	.17"ID x 1/4"OD (4.3mm x 6.4mm)	1/4"ID x 3/8"OD (6.4mm x 9.5mm)	22 oz/min (0.7 L/min)
	@ 500 ft (152 m)	1/4"ID x 3/8"OD (6.4mm x 9.5mm)		17 oz/min (0.5 L/min)
1.66 x 18"	@ 275 ft (84 m)	.17"ID x 1/4"OD (4.3mm x 6.4mm)	1/4"ID x 3/8"OD (6.4mm x 9.5mm)	12 oz/min (0.4 L/min)
	@ 500 ft (152 m)	1/4"ID x 3/8"OD (6.4mm x 9.5mm)		8 oz/min (240 mL/min)
.850 x 18"	@ 150 ft (46 m)	.17"ID x 1/4"OD (4.3mm x 6.4mm)		2 oz/min (59 mL/min)
.675 x 18"	@ 150 ft (46 m)	.17"ID x 1/4"OD (4.3mm x 6.4mm)		1 oz/min (27 mL/min)



The above example flow rates are based on 3' (0.9 m) of pump submergence. Typically, field environments will provide greater submergence (more than 10' (3 m)), which will dramatically increase flow.

Factors that increase flow:

- increased submergence (depth of pump below water line)
- a strong compressor, like the Geocontrol PRO, will enable fast pressure build up in the air line tubing and pump cavity
- a clean intake screen will maximize the amount of water entering into the pump

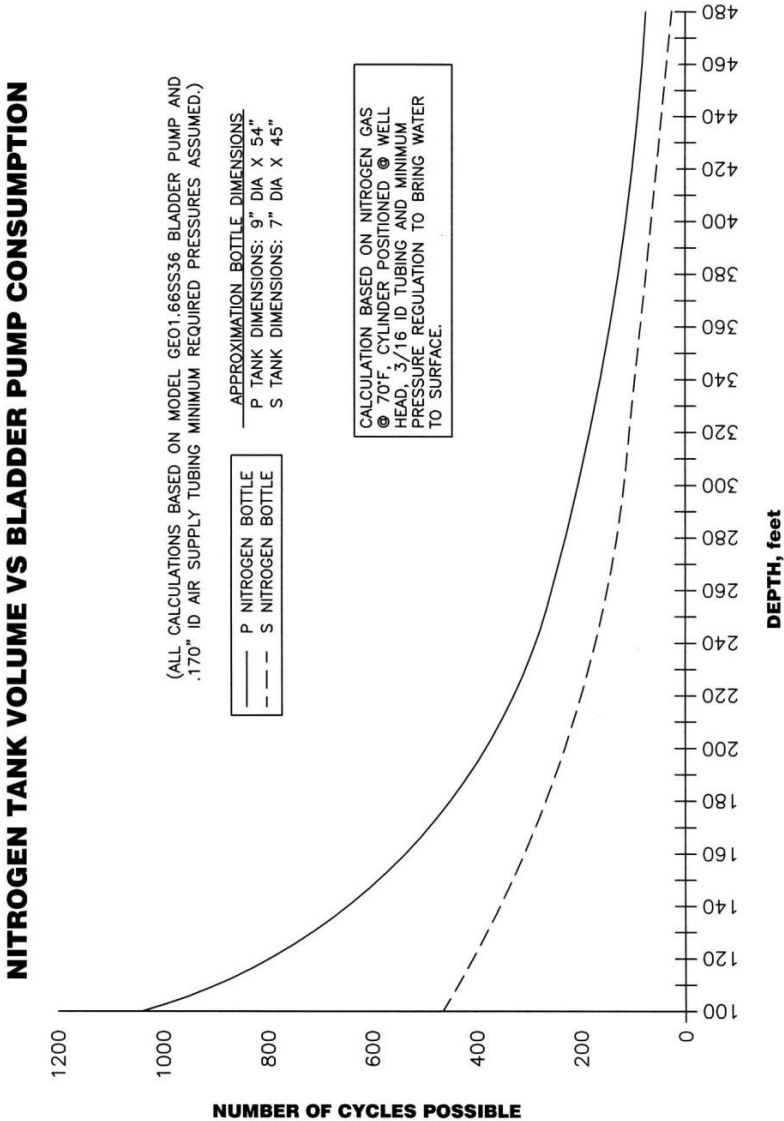

Figure 3-1: Tank Volume vs. BP Consumption

Section 4: System Maintenance

Bladder Pump

As with any pump, scheduled or periodic maintenance should be performed according to your sampling program and specific site conditions. Generally, the more turbid or sandy the water, the more maintenance and cleaning are required.

Replacement bladders, as well as other key components, can be found in *Section 7: Replacement Parts List*.

Disassemble Bladder Pump per instructions in this section, decontaminate or replace parts as needed, then reassemble.



Inspect O-rings and check balls for damage.
Replace Bladder if torn, ripped, or excessively worn.

Replacing the Bladder

1.66" Models

Pull pump from the well, it is not necessary to remove the air and sample lines from the pump. Take care, as the pump may be filled with fluid.

1. Hold the pump by its head with a towel or use the wrench flats, and turn the screen intake counter-clockwise to remove (see Figure 4-1).
 - The intake may be snug due to the high-pressure O-ring seal. Once the seal is broken, then intake should disengage easily.
2. Hold the pump by its head and slide or twist the housing off the pump body (see Figure 4-1).
3. Locate the Bladder clamps (see #3 on Figure 4-1).

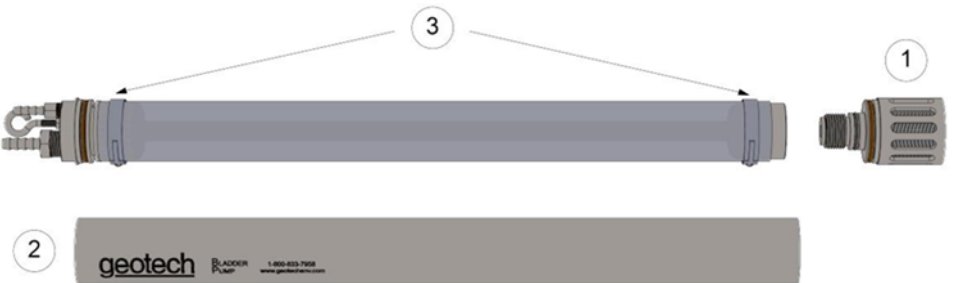

Figure 4-1: Accessing the Bladder Assembly

4. Obtain the clamp pincher tool (Geotech part # 11150031).
5. Pinch the tension hook and lift the end of the clamp until it releases from the retaining hooks (see Figure 4-2).

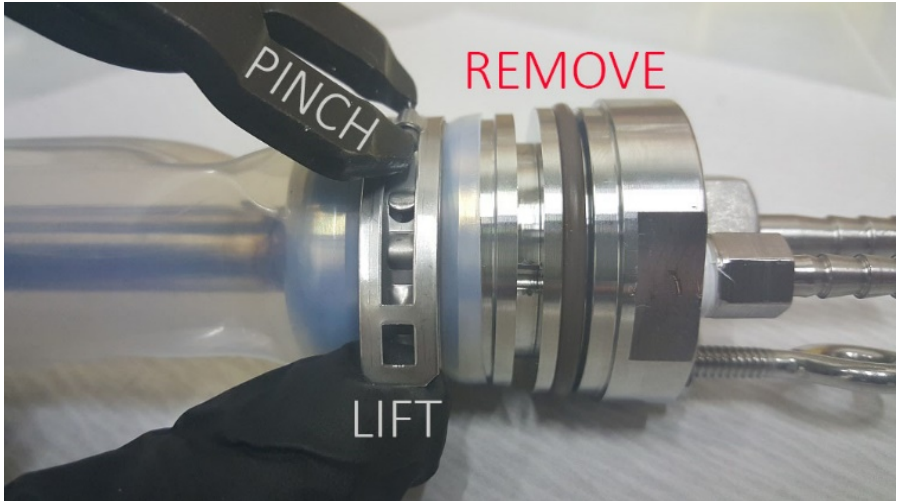

Figure 4-2: Removing the Bladder Clamp

6. Slide clamp off bladder.
 - Do this for both the top and the bottom bladder clamps.
7. Set the clamps aside, they are reusable.
8. Slide the bladder down over the pump body, decontaminate or replace as necessary.
9. Inspect O-rings for damage.
10. Replace O-rings as necessary.

Reassemble the 1.66" Models:

1. Slide the decontaminated or new bladder up the pump body and over the O-rings.
2. Ensure the O-rings are not dislodged and the bladder covers both O-rings with at least a 1/4" (.6cm) of clearance.
3. Slide the bladder clamps over the bladder and position each clamp over an O-ring, making sure the clamp and O-ring are aligned on center.

- Using the clamp tool (Geotech part # 11150031). Pinch the tension hook and use your thumb to guide the end of the clamp over the retaining hooks until the clamp is locked in place (see Figure 4-4).

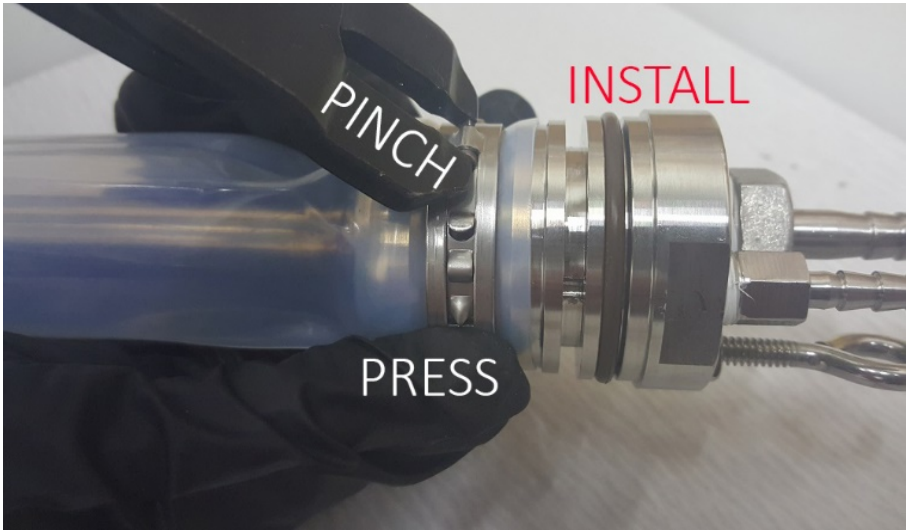

Figure 4-4: Installing the Bladder Clamp

- Slide the housing over the pump body.
- Lubricate the upper cap's O-ring using deionized water to ensure a pressure-ready installation.
- Twist the housing on the body until it is flush with the upper cap.
- Install the screen intake by lubricating the O-rings with deionized water and then turning clockwise into the pump's body.
- Hold the pump by its head to ensure the screen intake is fully secured.
 - There should be no gaps between the outer housing and top or bottom caps.
- Ensure the pump's fittings and safety cable are in good condition.

The pump is ready for service.

Remove the pump from the well. It is not necessary to remove the air and sample lines from the pump. Upon removal, the pump may be filled with fluid.

.850 and .675 Bladder Removal Steps

1. Remove the bottom intake assembly and outer housing by turning the housing counter-clockwise.
 - Use your hand or a strap wrench
 - DO NOT grip the hose barbs.
 - For .85 and .675 models, use a wrench that is one size bigger than the bolts on the hose barbs. (EX: use a 7/16 wrench on a .850 model)
 - Using a larger wrench will prevent the hose barbs from being removed. The tool should only be used for leverage to loosen the part.
 - If the bottom intake is difficult to remove, remove the snap ring, disc, and screen and then use a wrench for removal.



Figure 4-1: Removal of the bottom intake and outer housing

2. Remove the lower Compression Ring by pulling it off the end of the internal center tube assembly.

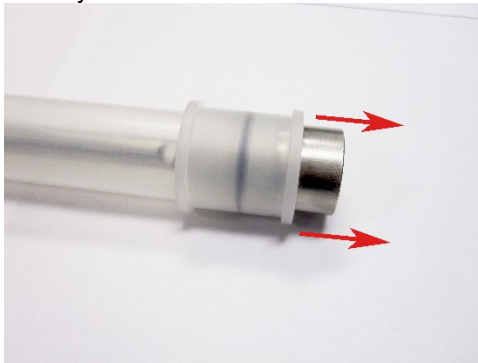

Figure 4-2: Removal of bottom Compression Ring

3. Remove the upper Compression Ring by sliding it over the bladder and over the end of the internal center tube assembly.



Figure 4-3: Removal of upper Compression Ring

4. Pulling from the lower end of the bladder, slide the bladder off the internal center tube weldment assembly.

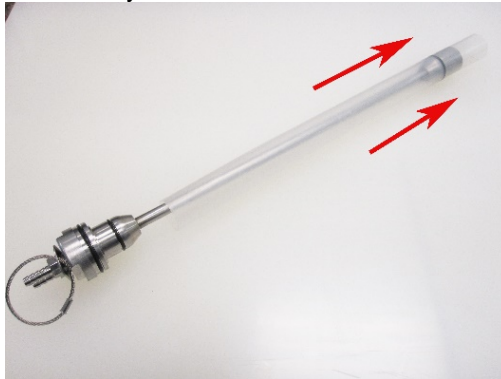

Figure 4-4: Removal of Bladder

5. Remove all O-rings.
 - If needed, use a flat object to help the O-ring out of the groove on the center tube weldment assembly,
 - Do not over-stretch, damage, or puncture the O-rings in any way.



Figure 4-5: Removal of O-rings

6. Clean and prepare replacement parts as needed.

Bladder Reassembly

1. Install O-ring on the cap of the center tube weldment assembly.



Figure 4-10: Cap O-ring

2. Install O-ring on the upper end of the center tube weldment assembly.

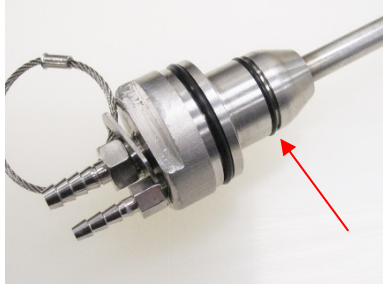

Figure 4-11: Upper end O-ring

3. Install O-ring on the lower end of the center tube weldment assembly.



Figure 4-12: Lower O-ring

4. Slide bladder onto the internal center tube weldment assembly, over the O-ring on the bottom end of the center tube assembly, and then over the O-ring on the upper end of the center tube weldment assembly.
 - Do not to roll the O-rings.
 - If needed, use Deionized water or a silicone based lubricant on the O-ring seals to help the bladder slide over the O-rings.



Figure 4-13a: Sliding bladder on



Figure 4-13b: Bladder entirely on

5. Slide the Compression Ring over the bladder to the upper end of the center tube weldment assembly.



Figure 4-14a: Compression Ring on Bladder



Figure 4-14b: Compression ring secured

6. With the upper end of the bladder secured by the Compression Ring slide the second compression ring over the end of the bladder until the O-ring is visible in the middle of the Compression Ring.
 - Compression rings that are made from other materials (ex: PTFE), will not be clear. The O-ring will not be visible.



Figure 4-15: Bottom Compression ring with visible O-ring

7. An alternate way to assemble the bladder is to:
 - a) Place both Compression Rings on the center tube weldment assembly

- b) Slide the bladder over the bottom O-ring, through the compression rings, and over the top O-rings until the bladder is flush with the upper end of the center tube weldment assembly (see Figure 4-13b)
- c) Slide the top compression ring to the upper end of the center tube weldment assembly (see Figure 4-14b)
- d) Slide the bottom compression ring to the lower end of the center tube weldment assembly (see Figure 4-15)

8. Replace the outer housing.

- Be sure the outer housing is sealed against the upper cap.



Figure 4-16a: Incorrect Installation



Figure 4-16b: Correct Installation

9. Replace the bottom intake assembly by screwing it into the bottom of the pump.

- Reassemble bottom intake if previously disassembled by inserting the screen, disc, and snap ring into the lower cap.
- Be sure the bottom intake assembly is sealed against the outer housing.



Figure 4-17a: Incorrect Installation

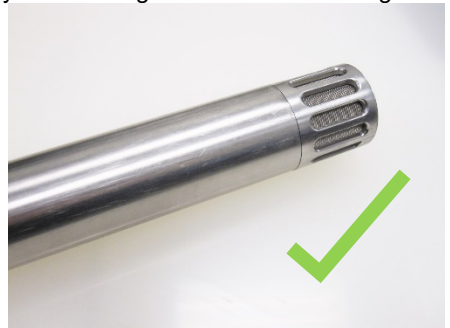

Figure 4-17b Correct Installation



Inspect O-rings and bladder for damage.
Replace if torn, ripped, or excessively worn.

Compression Fittings

Tubing can wear out over time if compression fittings are overtightened. After repair, ensure that compression fittings are “snug”. One full rotation after hand tightening of the nut should be enough to tighten the compression fitting.

Section 5: System Troubleshooting

Problem: Air is cycling through controller but will not pump.

Solutions

- Discharge and Fill times are not set correctly. Check and adjust Discharge and Fill cycle times (i.e. if Discharge time is too long or if Fill and Discharge time is too short).
- Possible compromise in air line tubing. Check airline pumps for leaks. If needed, repair using compression union or replace tubing.
- Check pump intake screen for blockage and clean as needed.

Problem: Controller is cycling but the pump stops producing water.

Solutions

- Check drawdown level of water in the well. Ensure the pump is fully submerged and off of the bottom of the well.
- Check air pressure at the regulator and adjust as necessary (See *Section 3: Determining Operation Pressure.*)
- Check for kinks in the discharge line.
- Check pump intake screen for obstructions.
- Discharge time is too long or Fill time is too short; causes pressure build up in pump, causing the pump not to fill.
- Check power source, assure a strong reliable power supply. If using old or weak battery, the control valves may not operate properly.

Problem: Getting air bubbles in sample line.

Solutions

- Overcharging pump. Reduce discharge cycle time so the discharge cycle ends as fluid discharge trails off. Inspect pump for compromised bladder or O-rings.
- Pump is being over pressurized. Reduce air pressure to what is necessary to overcome pumping head.
- Check discharge line for holes or kinks. Repair using compression union or replace tubing.
- Ensure Bladder clamps are properly installed.

Problem: Discharge line drains back into pump.

Solution

- Check valve at the top of the pump is compromised. Remove hose barb on pump discharge outlet. Check the check ball seat for debris. Clean and re-install.
- Check the upper ball for roundness, pitting or scaling.

Problem: Discharge sucks up water at sampling end, especially during fill cycle.

Solution

The compression fitting ferrule has cut into the tubing. Follow installation instructions in *Section 2: System Installation.*

If you are experiencing other problems than mentioned above, please call Geotech Technical Support for immediate assistance, (800) 833-7958.

Section 6: System Specifications

	1.66 36"		1.66 18"		0.850"	0.675"
	High Pressure	Low Pressure	High Pressure	Low Pressure		
Pump Body	316 SS					
Fittings	316 SS					
Fitting Type	Compression	Hose barb	Compression	Hose barb	Hose barb	
Bladder Material	Virgin PE or PTFE					
Bladder Retainer	316 SS Clamp				PTFE Collar	
Pump O.D.	1.66" (4.2 cm)				.850" (2.2 cm)	.675" (1.7 cm)
Length	38" (96.5 cm)		20" (51 cm)		18 5/8" (47.3 cm)	18 3/4" (47.6 cm)
Weight	5.5 lbs. (2.5 kg)		3.5 lbs. (1.6 kg)		1.1 lbs. (0.5 kg)	.8 lbs. (0.4 kg)
Volume/ Cycle	22 oz. (650 mL)		11 oz. (325 mL)		1 oz. 29 mL	0.5 oz. 15 mL
Max Operating Temp.	PTFE Bladder: 32°F-212°F (0°C-100°C) PE Bladder: 32°F -185°F (0°C -85°C)					
Min. Well I.D.	2" (5 cm)				1" (2.5 cm)	.75" (1.9 cm)
Max. Sample Depth	1000 ft. (305 m)	290 ft. (88 m)	1000 ft. (305 m)	290 ft. (88 m)	200' (61 m)	
Min. Operating Pressure	5 psi ash* (.34 bar)					
Max. Operating Pressure	500 psi (34 bar)	125 psi (8.6 bar)	500 psi (34 bar)	125 psi (8.6 bar)	100 psi (7bar)	
Proof Pressure	675 psi (46 bar)	187 psi (13 bar)	675 psi (46 bar)	187 psi (13 bar)	150 psi (10 bar)	
Burst Pressure	1000 psi (69 bar)	300 psi (21 bar)	1000 psi (69 bar)	300 psi (21 bar)	300 psi (20 bar)	
Tubing Size (I.D. x O.D.)						
Air Line	1/4" x 3/8" (6 x 10 mm)	.17" x 1/4" (4 x 6 mm)	1/4" x 3/8" (6 x 10 mm)	.17" x 1/4" (4 x 6 mm)	.17" x 1/4" (4 x 6 mm)	
Discharge Line		1/4" x 3/8" (6 x 10 mm)		1/4" x 3/8" (6 x 10 mm)		

*ash = above static head

Section 7: Replacement Parts List

1.66 Bladder Pump Components (36" & 18" LOW Pressure Models)

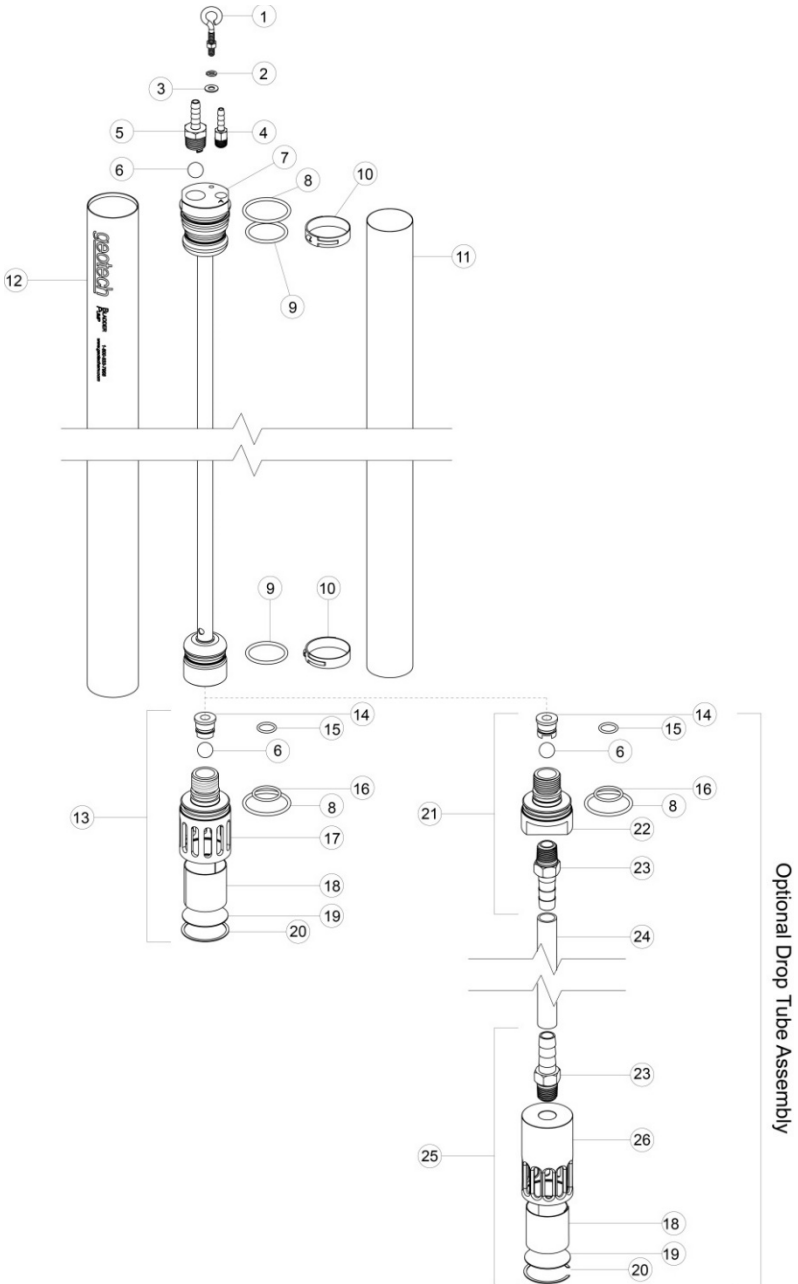

Bladder Pump, 1.66, Stainless Steel, 36", Low Pressure - 81150120

Item	Qty	Description	Part No.
1	1	EYEBOLT, SS316, 10-24, 1" SHANK	16600347
2	1	WASHER, SS6, #10, LOCK	11150449
3	1	WASHER, SS6, #10	11150450
4	1	HOSEBARB, SS6, .170 x 1/8" MPT, AIR LINE	21150019
5	1	HOSEBARB, SS6, MOD, 1/4" x 3/8" MPT, DISCHARGE	21150145
6	2	BALL, SS6, 1/2"	17500082
7	1	CAP, UPPER WELDMENT, SS, 1.66x36"	21150143
8	2	O-RING, VITON, 2.5mm x 36mm, BROWN	11150318
	2	O-RING, 2.5mm x 36mm, BUNA-N	11154056
9	2	O-RING, VITON, #123, BROWN	11200299
	2	O-RING, BUNA-N, #123 (BLACK)	11154060
10	2	CLAMP, SS6, LOW PROFILE	11150444
11	1	BLADDER, PTFE, 1.66SS36, DEDICATED	51150139
	1	BLADDER, PE, 1.66SS36, DEDICATED	51150158
12	1	HOUSING, SS6, DED, 1.66 x 36"	51150142
13	1	ASSY, BOTTOM INTAKE, 1.66 BP	51150067
	1	ASSY, BOTTOM INTAKE, 1.66 BP, PFAS FREE	51150145
14	1	PLUG, BALL RETAINER, 1.66 BP	21150096
15	1	O-RING, VITON, #014, BROWN	17500119
	1	O-RING, #014, BUNA-N	11154057
16	1	O-RING, VITON, 2mm x 20mm, BROWN	11150332
	1	O-RING, 2mm x 20mm, BUNA-N	11154058
17	1	CAP, LOWER, SS6, 1.66 BP	21150094
18	1	SCREEN, INTAKE, SS6, 1.66 BP	21150095
19	1	DISC, SS, 1.66, BLADDER PUMP	21150148
20	1	RING, SNAP, SS6, INTERNAL, 1.66 BP	11150051
21	§	ASSY, LOWER CAP, 1.66 BP, DROP TUBE WITH 1/2" HOSE BARB	51150128
	§	ASSY, LOWER CAP, 1.66 BP, DROP TUBE w/ 1/2" HB, PFAS FREE	51150160
22	§	DROP TUBE, CAP LOWER, 1.66 BP, SS	21150098
23	§	HOSE BARB, SS6, 1/2 x 3/8" MPT	16600217
24	§	TUBING, PE, 1/2 x 5/8"	87050504
25	§	ASSY, INTAKE, 1.66, DROP TUBE	51150071
26	§	INTAKE, DROP TUBE, 1.66"	21150113
Not Shown:			
	1	MANUAL, BLADDER PUMPS	21150035
	§	TOOL, BLADDER PUMP, PINCER, 5mm	11150031
	§	SERVICE KIT, 1.66 SS BP, O-RING SET [Item 8 (2), 9 (2), 15 (1), 16 (1)]	91150023
	§	SERVICE KIT, 1.66 SS BP, O-RING SET, PFAS FREE [Item 8 (2), 9 (2), 15 (1), 16 (1)]	91150026

§ = Sold Separately

Bladder Pump, 1.66, Stainless Steel, 18", Low Pressure - 81150122

Item	Qty	Description	Part No.
1	1	EYEBOLT, SS316, 10-24, 1" SHANK	16600347
2	1	WASHER, SS6, #10, LOCK	11150449
3	1	WASHER, SS6, #10	11150450
4	1	HOSEBARB, SS6, .170 x 1/8" MPT, AIR LINE	21150019
5	1	HOSEBARB, SS6, MOD, 1/4" x 3/8" MPT, DISCHARGE	21150145
6	2	BALL, SS6, 1/2"	17500082
7	1	CAP, UPPER WELDMENT, SS6, 1.66 x 18", DEDICATED	21150147
8	2	O-RING, VITON, 2.5mm x 36mm, BROWN	11150318
	2	O-RING, 2.5mm x 36mm, BUNA-N	11154056
9	2	O-RING, VITON, #123, BROWN	11200299
	2	O-RING, BUNA-N, #123 (BLACK)	11154060
10	2	CLAMP, SS6, LOW PROFILE	11150444
11	1	BLADDER, PTFE, 1.66SS18, DEDICATED	51150140
	1	BLADDER, PE, 1.66SS18, DEDICATED	51150159
12	1	HOUSING, SS6, DED, 1.66 x 18"	51150143
13	1	ASSY, BOTTOM INTAKE, 1.66 BP	51150067
	1	ASSY, BOTTOM INTAKE, 1.66 BP, PFAS FREE	51150145
14	1	PLUG, BALL RETAINER, 1.66 BP	21150096
15	1	O-RING, VITON, #014, BROWN	17500119
	1	O-RING, #014, BUNA-N	11154057
16	1	O-RING, VITON, 2mm x 20mm, BROWN	11150332
	1	O-RING, 2mm x 20mm, BUNA-N	11154058
17	1	CAP, LOWER, SS6, 1.66 BP	21150094
18	1	SCREEN, INTAKE, SS6, 1.66 BP	21150095
19	1	DISC, SS, 1.66, BLADDER PUMP	21150148
20	1	RING, SNAP, SS6, INTERNAL, 1.66 BP	11150051
21	§	ASSY, LOWER CAP, 1.66 BP, DROP TUBE WITH 1/2" HOSE BARB	51150128
	§	ASSY, LOWER CAP, 1.66 BP, DROP TUBE w/ 1/2" HB, PFAS FREE	51150160
22	§	DROP TUBE, CAP LOWER, 1.66 BP, SS	21150098
23	§	HOSE BARB, SS6, 1/2 x 3/8" MPT	16600217
24	§	TUBING, PE, 1/2 x 5/8"	87050504
25	§	ASSY, INTAKE, 1.66, DROP TUBE	51150071
26	§	INTAKE, DROP TUBE, 1.66"	21150113
Not Shown:			
	1	MANUAL, BLADDER PUMPS	21150035
	§	TOOL, BLADDER PUMP, PINCER, 5mm	11150031
	§	SERVICE KIT, 1.66 SS BP, O-RING SET [Item 8 (2), 9 (2), 15 (1), 16 (1)]	91150023
	§	SERVICE KIT, 1.66 SS BP, O-RING SET, PFAS FREE [Item 8 (2), 9 (2), 15 (1), 16 (1)]	91150026

§ = Sold Separately

1.66 Bladder Pump Components (36" & 18" HIGH Pressure Models)

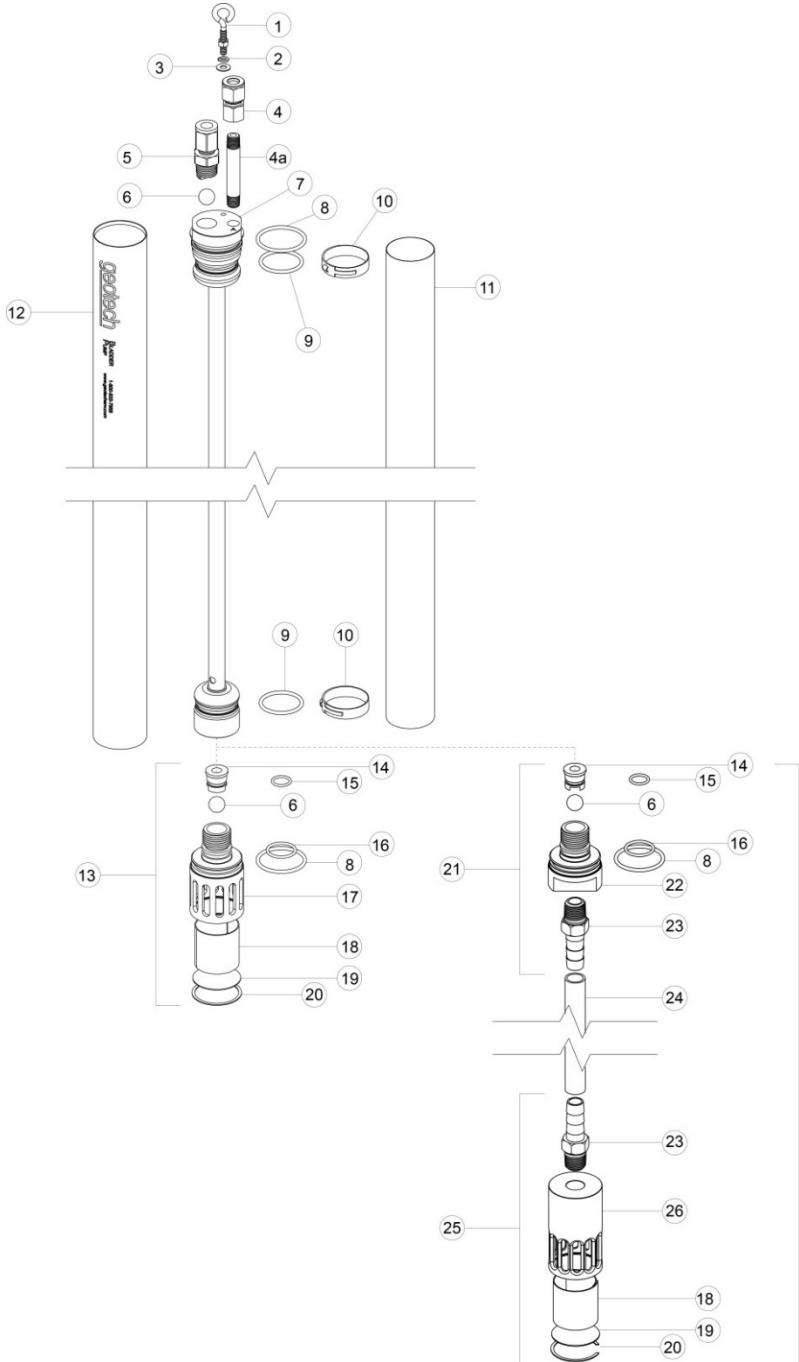

Bladder Pump, 1.66, Stainless Steel, 36", High Pressure - 81150119

Item	Qty	Description	Part No.
1	1	EYEBOLT, SS316, 10-24, 1" SHANK	16600347
2	1	WASHER, SS6, #10, LOCK	11150449
3	1	WASHER, SS6, #10	11150450
4	1	CMPRSN FITTING, SS6, 3/8 TUBE x 1/8 FPT	11150446
4a	1	NIPPLE, SS6, 2.5" x 1/8" MPT	11150447
5	1	CMPRSN FITTING, MOD, SS6, 3/8 TUBE x 3/8" MPT	21150144
6	2	BALL, SS6, 1/2"	17500082
7	1	CAP, UPPER WELDMENT, SS, 1.66x36"	21150143
8	2	O-RING, VITON, 2.5mm x 36mm, BROWN	11150318
	2	O-RING, 2.5mm x 36mm, BUNA-N	11154056
9	2	O-RING, VITON, #123, BROWN	11200299
	2	O-RING, BUNA-N, #123 (BLACK)	11154060
10	2	CLAMP, SS6, LOW PROFILE	11150444
11	1	BLADDER, PTFE, 1.66SS36, DEDICATED	51150139
	1	BLADDER, PE, 1.66SS36, DEDICATED	51150158
12	1	HOUSING, SS6, DED, 1.66 x 36"	51150142
13	1	ASSY, BOTTOM INTAKE, 1.66 BP	51150067
	1	ASSY, BOTTOM INTAKE, 1.66 BP, PFAS FREE	51150145
14	1	PLUG, BALL RETAINER, 1.66 BP	21150096
15	1	O-RING, VITON, #014, BROWN	17500119
	1	O-RING, #014, BUNA-N	11154057
16	1	O-RING, VITON, 2mm x 20mm, BROWN	11150332
	1	O-RING, 2mm x 20mm, BUNA-N	11154058
17	1	CAP, LOWER, SS6, 1.66 BP	21150094
18	1	SCREEN, INTAKE, SS6, 1.66 BP	21150095
19	1	DISC, SS, 1.66, BLADDER PUMP	21150148
20	1	RING, SNAP, SS6, INTERNAL, 1.66 BP	11150051
21	§	ASSY, LOWER CAP, 1.66 BP, DROP TUBE WITH 1/2" HOSE BARB	51150128
	§	ASSY, LOWER CAP, 1.66 BP, DROP TUBE w/ 1/2" HB, PFAS FREE	51150160
22	§	DROP TUBE, CAP LOWER, 1.66 BP, SS	21150098
23	§	HOSE BARB, SS6, 1/2 x 3/8" MPT	16600217
24	§	TUBING, PE, 1/2 x 5/8"	87050504
25	§	ASSY, INTAKE, 1.66, DROP TUBE	51150071
26	§	INTAKE, DROP TUBE, 1.66"	21150113
Not Shown:			
	1	MANUAL, BLADDER PUMPS	21150035
	§	TOOL, BLADDER PUMP, PINCER, 5mm	11150031
	§	FERRULE SETS, SS6, 3/8"	57200010
	§	SERVICE KIT, 1.66 SS BP, O-RING SET [Item 8 (2), 9 (2), 15 (1), 16 (1)]	91150023
	§	SERVICE KIT, 1.66 SS BP, O-RING SET, PFAS FREE [Item 8 (2), 9 (2), 15 (1), 16 (1)]	91150026

§ = Sold Separately

Bladder Pump, 1.66, Stainless Steel, 18", High Pressure - 81150121

Item	Qty	Description	Part No.
1	1	EYEBOLT, SS316, 10-24, 1" SHANK	16600347
2	1	WASHER, SS6, #10, LOCK	11150449
3	1	WASHER, SS6, #10	11150450
4	1	CMPRSN FITTING, SS6, 3/8 TUBE x 1/8 FPT	11150446
4a	1	NIPPLE, SS6, 2.5" x 1/8" MPT	11150447
5	1	CMPRSN FITTING, MOD, SS6, 3/8 TUBE x 3/8" MPT	21150144
6	2	BALL, SS6, 1/2"	17500082
7	1	CAP, UPPER WELDMENT, SS6, 1.66 x 18", DEDICATED	21150147
8	2	O-RING, VITON, 2.5mm x 36mm, BROWN	11150318
	2	O-RING, 2.5mm x 36mm, BUNA-N	11154056
9	2	O-RING, VITON, #123, BROWN	11200299
	2	O-RING, BUNA-N, #123 (BLACK)	11154060
10	2	CLAMP, SS6, LOW PROFILE	11150444
11	1	BLADDER, PTFE, 1.66SS18, DEDICATED	51150140
	1	BLADDER, PE, 1.66SS18, DEDICATED	51150159
12	1	HOUSING, SS6, DED, 1.66 x 18"	51150143
13	1	ASSY, BOTTOM INTAKE, 1.66 BP	51150067
	1	ASSY, BOTTOM INTAKE, 1.66 BP, PFAS FREE	51150145
14	1	PLUG, BALL RETAINER, 1.66 BP	21150096
15	1	O-RING, VITON, #014, BROWN	17500119
	1	O-RING, #014, BUNA-N	11154057
16	1	O-RING, VITON, 2mm x 20mm, BROWN	11150332
	1	O-RING, 2mm x 20mm, BUNA-N	11154058
17	1	CAP, LOWER, SS6, 1.66 BP	21150094
18	1	SCREEN, INTAKE, SS6, 1.66 BP	21150095
19	1	DISC, SS, 1.66, BLADDER PUMP	21150148
20	1	RING, SNAP, SS6, INTERNAL, 1.66 BP	11150051
21	§	ASSY, LOWER CAP, 1.66 BP, DROP TUBE WITH 1/2" HOSE BARB	51150128
	§	ASSY, LOWER CAP, 1.66 BP, DROP TUBE w/ 1/2" HB, PFAS FREE	51150160
22	§	DROP TUBE, CAP LOWER, 1.66 BP, SS	21150098
23	§	HOSE BARB, SS6, 1/2 x 3/8" MPT	16600217
24	§	TUBING, PE, 1/2 x 5/8"	87050504
25	§	ASSY, INTAKE, 1.66, DROP TUBE	51150071
26	§	INTAKE, DROP TUBE, 1.66"	21150113
Not Shown:			
	1	MANUAL, BLADDER PUMPS	21150035
	§	TOOL, BLADDER PUMP, PINCER, 5mm	11150031
	§	FERRULE SETS, SS6, 3/8"	57200010
	§	SERVICE KIT, 1.66 SS BP, O-RING SET [Item 8 (2), 9 (2), 15 (1), 16 (1)]	91150023
	§	SERVICE KIT, 1.66 SS BP, O-RING SET, PFAS FREE [Item 8 (2), 9 (2), 15 (1), 16 (1)]	91150026

§ = Sold Separately

.850 Stainless Steel Bladder Pump Components

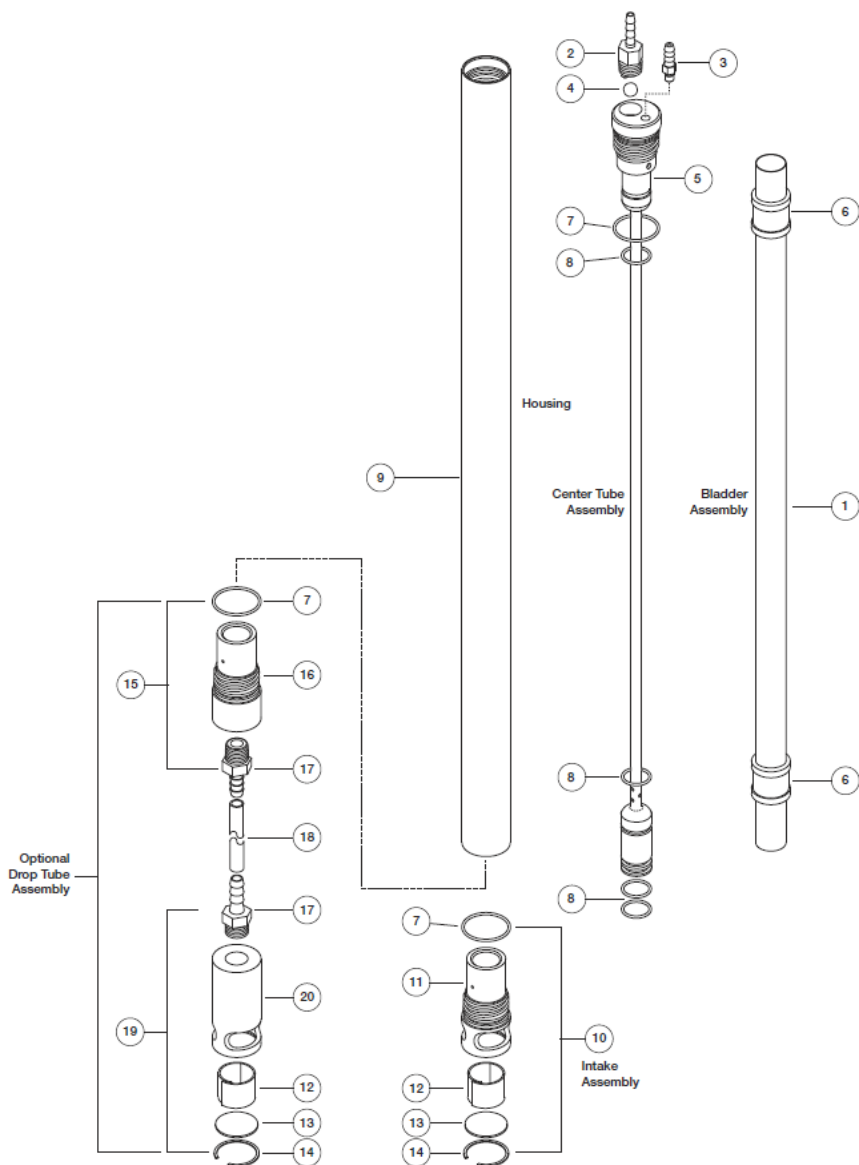

Bladder Pump, .850, Stainless Steel, Screened - 81150115

Item	Qty	Description	Part No.
1	1	BLADDER ,PTFE, .85 BP	51150051
	1	BLADDER, PE, .85 BP, EA	21150100
	§	BLADDER, PE, .85, CE, 12PK	21150099
2	1	HOSEBARB, SS6, MOD, .170 x 1/8 NPT DISCHARGE	11150118
3	1	HOSEBARB, SS6, .170 x 10/24 AIR	17200245
4	2	BALL, SS6, 1/4"	17500079
5	1	CAP UPPER WELDMENT, SS6, .85 BP	21150045
6	2	RING, COMPRESSION, PTFE, .850 BP, CE	21150048
	2	RING, COMPRESSION, HDPE, .850 BP, CE	21150150
7	2	O-RING, VITON, CS .070, ID 17.2mm	17500112
	2	O-RING, #017, BUNA-N	11150470
8	4	O-RING, VITON, #012	17500111
	4	O-RING, #012, BUNA-N	11150471
9	1	HOUSING, SS6, .850, BP	21150047
10	1	ASSY, BOTTOM INTAKE, .85 BP	51150118
	1	ASSY, BOTTOM INTAKE, .85 BP, PFAS FREE	51150147
11	1	CAP, LOWER, SS6, .850, BP	21150046
12	1	SCREEN, INTAKE, SS6, .85 BP	21150050
13	1	DISC, SS6, .85 BP	21150049
14	1	RING, SNAP, SS6, INTERNAL, .85 BP	11150053
15	§	ASSY, LOWER CAP, .850 BP, DROP TUBE, CE, w/ 1/4" HOSE BARB	51150129
	§	ASSY, LOWER CAP, .850 BP, DROP TUBE, CE, w/ 1/4" HOSE BARB, PFAS FREE	51150148
16	§	DROP TUBE, CAP LOWER, .850 BP, CE, SS	21150109
17	§	HOSEBARB, SS6, 1/4 x 1/8" MPT	17200072
18	§	TUBING, PE, 1/4 x 3/8", FT	87050502
19	§	ASSY, INTAKE, .850 BP, DROP TUBE, CE, w/ 1/4" HOSE BARB	51150069
20	§	INTAKE, DROP TUBE, .850 BP, CE, SS	21150111
Not Shown:			
	1	MANUAL, BLADDER PUMPS	21150035
	§	SPARE PARTS KIT, .85, BP, CE [Items 4 (2), 6 (2), 7 (2), 8 (4), 12, 13, 14]	51150123
	§	SPARE PARTS KIT, .85, BP, CE, PFAS FREE [Items 4 (2), 6 (2), 7 (2), 8 (4), 12, 13, 14]	51150150
	§	SERVICE KIT, .85 BP, O-RING SET, CE [Items 7 (2), 8 (4)]	91150013
	§	SERVICE KIT, .85 BP, O-RING SET, CE, PFAS FREE [Items 7 (2), 8 (4)]	91150024
	§	THREAD TAPE, PFAS FREE, .5" x 600'	21150153

§ = Sold Separately

.675 Stainless Steel Bladder Pump Components

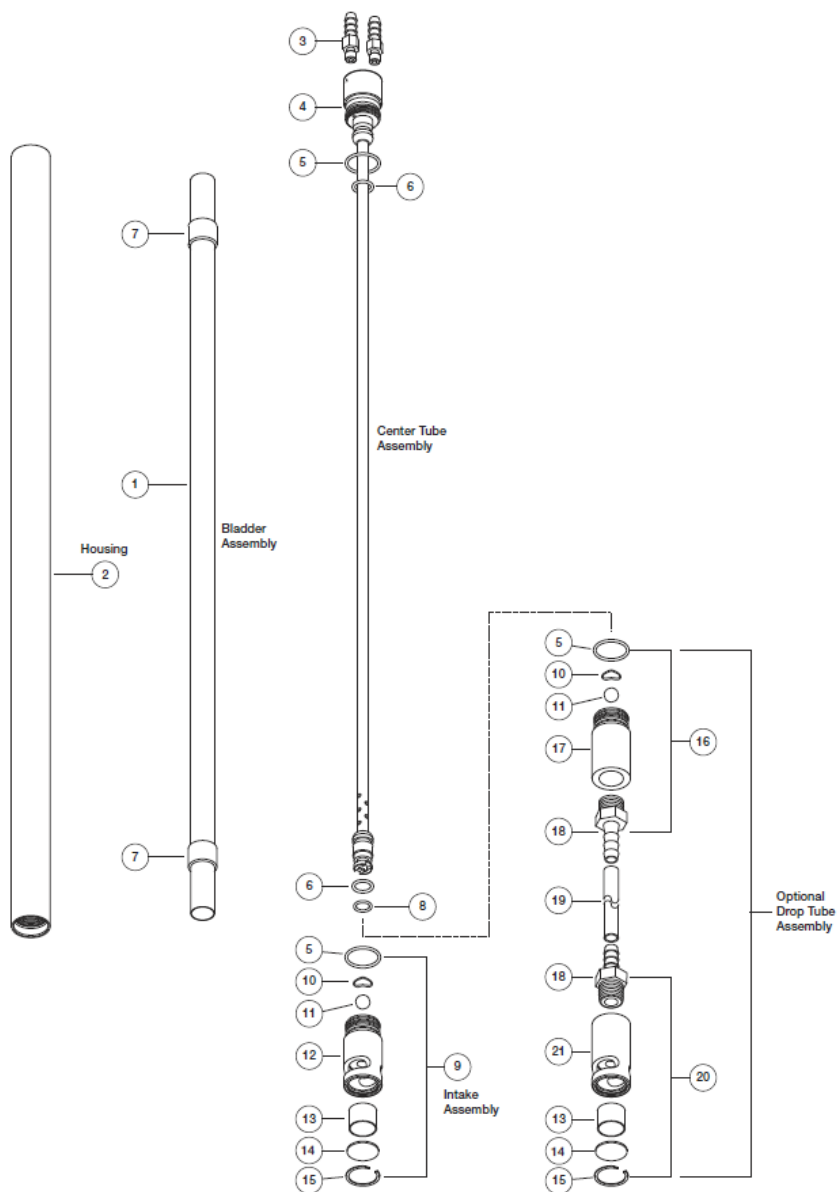

Bladder Pump, .675, Stainless Steel, Screened - 81150117

Item	Qty	Description	Part No.
1	1	BLADDER, PTFE, .675, BP, CE	51150126
	1	BLADDER, PE, .675, EA	21150102
	§	BLADDER, PE, .675, CE, 12PK	21150101
2	1	HOUSING, SS6, .675, BP	21150032
3	2	HOSEBARB, SS6, .170 x 10/24 AIR	17200245
4	1	WELDMENT, INNER, SS6, .675 BP	51150125
5	2	O-RING, VITON, #014	17500119
	2	O-RING, #014, BUNA-N	11154057
6	2	O-RING, VITON, #107	17500604
	2	O-RING, #107, BUNA-N	11150468
7	2	RING, COMPRESSION, PTFE, .675 BP, CE	21150106
	2	RING, COMPRESSION, HDPE, .675 BP, CE	21150151
8	1	O-RING, VITON, #009	17500113
	1	O-RING, #009, BUNA-N	11150469
9	1	ASSY, BOTTOM INTAKE, .675, BP	51150120
	1	ASSY, BOTTOM INTAKE, .675, BP, PFAS FREE	51150151
10	1	RETAINER, BALL, .675 BP, TACO	21150087
11	1	BALL, SS6, 1/4"	17500079
12	1	CAP, LOWER, SS6, .675 BP	21150031
13	1	SCREEN, INTAKE, SS6, .675 BP	11150317
14	1	DISC, SS, .675 BP	21150033
15	1	RING, SNAP, SS, .675 BP	11150182
16	§	ASSY, LOWER CAP, .675 BP, DROP TUBE, CE, w/ 1/4" HOSE BARB	51150130
	§	ASSY, LOWER CAP, .675 BP, DROP TUBE, CE, w/ 1/4" HOSE BARB, PFAS FREE	51150152
17	§	DROP TUBE, CAP LOWER, .675 BP, CE, SS	21150110
18	§	HOSE BARB, SS6, 1/4 x 1/8" MPT	17200072
19	§	TUBING, PE, 1/4 x 3/8", FT	87050502
20	§	ASSY, INTAKE .675 BP, DROP TUBE, CE, w/ 1/4" HOSE BARB	51150070
21	§	INTAKE, DROP TUBE, .675 BP, CE, SS	21150112
Not Shown:			
	1	MANUAL, BLADDER PUMPS	21150035
	§	SPARE PARTS KIT, .675, BP, CE [Items 5(2), 6 (2), 7(2), 8, 10, 11, 13, 14, 15]	51150124
	§	SPARE PARTS KIT, .675, BP, CE, PFAS FREE [Items 5(2), 6 (2), 7(2), 8, 10, 11, 13, 14, 15]	51150154
	§	SERVICE KIT, .675 BP, O-RING SET, CE [Items 5 (2), 6 (2), 8]	91150014
	§	SERVICE KIT, .675 BP, O-RING SET, CE, PFAS FREE [Items 5 (2), 6 (2), 8]	91150025
	§	THREAD TAPE, PFAS FREE, .5" x 600'	21150153

§ = Sold Separately

DOCUMENT REVISIONS		
Project#	DESCRIPTION	REV/DATE
1375	Release, SP	3/11/2014
EDCF # 1870	Corrected Replacement Parts List (Ch. 7) for 1.66 pump, SP	2/17/2015
0992	Updated Manual to show new style 1.66 pump, SP	1/11/2015
EDCF #2001	Updated part numbers and minor formatting, SR	10/27/16
1560	Adding temperature spec to Section 6: System Specifications. (185F/85C), PTFE to SS Disc in 1.66 models, StellaR	5/25/2017
1565	Added compression fitting instructions, StellaR	9/18/2017
1597	Added part # 91150023 – O-ring service kit, - StellaR	1/17/2018
1597	Clarified part list – notes between included and items sold separately from pump. Included items in O-ring service kit for 1.66 pumps – StellaR	1/22/2018
1749	Changed EDCF to Project in Document Revisions. Removed all “project”. Indicated an EDCF where changes were made in an EDCF. Changed all PTFE disc description to SS. (.675 and .850 builds) – StellaR	3/18/2019
1918	Updated maintenance instructions with alternate way to reassemble bladder. Removed specified part numbers – StellaR	1/14/2020
-	Corrected table of contents – StellaR	6/15/2020
2311	Added Virgin PE to document – AH Updated parts list with PFAS free parts – GR	8/8/2023

The Warranty

For a period of one (1) year from date of first sale, product is warranted to be free from defects in materials and workmanship. Geotech agrees to repair or replace, at Geotech's option, the portion proving defective, or at our option to refund the purchase price thereof. Geotech will have no warranty obligation if the product is subjected to abnormal operating conditions, accident, abuse, misuse, unauthorized modification, alteration, repair, or replacement of wear parts. User assumes all other risk, if any, including the risk of injury, loss, or damage, direct or consequential, arising out of the use, misuse, or inability to use this product. User agrees to use, maintain and install product in accordance with recommendations and instructions. User is responsible for transportation charges connected to the repair or replacement of product under this warranty.

Equipment Return Policy

A Return Material Authorization number (RMA #) is required prior to return of any equipment to our facilities, please call 800 number for appropriate location. An RMA # will be issued upon receipt of your request to return equipment, which should include reasons for the return. Your return shipment to us must have this RMA # clearly marked on the outside of the package. Proof of date of purchase is required for processing of all warranty requests.

This policy applies to both equipment sales and repair orders.

FOR A RETURN MATERIAL AUTHORIZATION, PLEASE CALL OUR SERVICE DEPARTMENT AT 1-800-833-7958 OR 1-800-275-5325.

Model Number: _____
Serial Number: _____
Date: _____

Equipment Decontamination

Prior to return, all equipment must be thoroughly cleaned and decontaminated. Please make note on RMA form, the use of equipment, contaminants equipment was exposed to, and decontamination solutions/methods used.

Geotech reserves the right to refuse any equipment not properly decontaminated. Geotech may also choose to decontaminate equipment for a fee, which will be applied to the repair order invoice.

Geotech Environmental Equipment, Inc.
2650 East 40th Avenue Denver, Colorado 80205
(303) 320-4764 • **(800) 833-7958** • FAX (303) 322-7242
email: sales@geotechenv.com website: www.geotechenv.com