

# AR4

# 4" Auto-Reclaimer

Installation and Operation Manual





## Table of Contents

Section 1: System Description .....	3
Function and Theory .....	3
System Components .....	4
Section 2: System Installation .....	5
System Schematic .....	6
Pump Activation Levels .....	8
Air Consumption .....	9
Airline Supply Pressure Drops .....	10
Deploying Multiple Pumps .....	11
Section 3: System Operation .....	13
Section 4: System Specifications .....	14
Performance Curves: AR4 Short Series .....	15
Performance Curves: AR4 Long Series .....	17
Performance Curves: AR4 EXT Series .....	19
Section 5: Replacement Parts .....	22
AR4 Replacement Parts List .....	22
Replacement Parts Diagram .....	23
Section 6: System Maintenance .....	25
Maintenance Schedule .....	25
Maintenance Operations .....	25
Required Tools .....	25
Supplies* .....	25
Disassembly Instructions .....	26
Housing and Bottom Cap .....	26
Retainer and Float .....	27
Control Rod/ Valve Assy. ....	28
Section 7: System Troubleshooting .....	29
Appendix A –System Specifications - Metric .....	31
Performance Curves: AR4 Short Series - Metric .....	31
Performance Curves: AR4 Long Series - Metric .....	33
Performance Curves AR4 EXT Series- Metric .....	35
Air Consumption- Metric .....	37
Air Supply Pressure Drops – Metric .....	38
Discharge Trunkline Sizing – Metric .....	40
The Warranty .....	42
Equipment Return Policy .....	42
Equipment Decontamination .....	42

# Section 1: System Description

## Function and Theory

The Geotech 4" Auto-Reclaimer (AR4) is an automatic and controller-less, positive air-displacement pump that works without the use of any external controls, relays, bleeder tubes or bubblers. The AR4 requires only a regulated standard industrial compressed air source to operate.

The AR4 is a fixed intake, Automatic total fluids recovery pump which can recover fluids from depths of up to 250' (76.2 m). Based on specific site requirements, the AR4 is offered in three lengths: short, long, and extended (Ext) each of which can be ordered to accommodate fluid intake with a top screen inlet, a 4" (10 cm) bottom screen, a flat bottom screen, or any combination of top and bottom. Intake screens allow for pumping fluid with up to 1/8" diameter suspended particles.

The AR4 can also operate under both positive and \*negative (vacuum) pressure environments. The pump is designed to self-adjust the discharge flow rate automatically to match individual well recharge rates (up to the pumps maximum flow rate based on individual site conditions).

\*Vacuum conditions may require a Vacuum Equalizer if venting out of the recovery well. Contact your Geotech Technical Sales representative for more information.

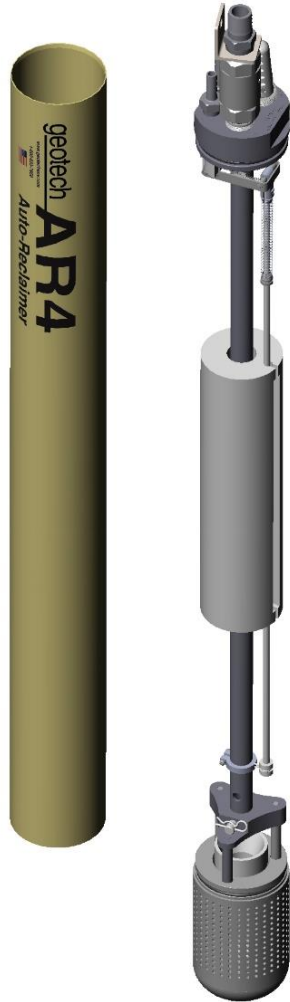
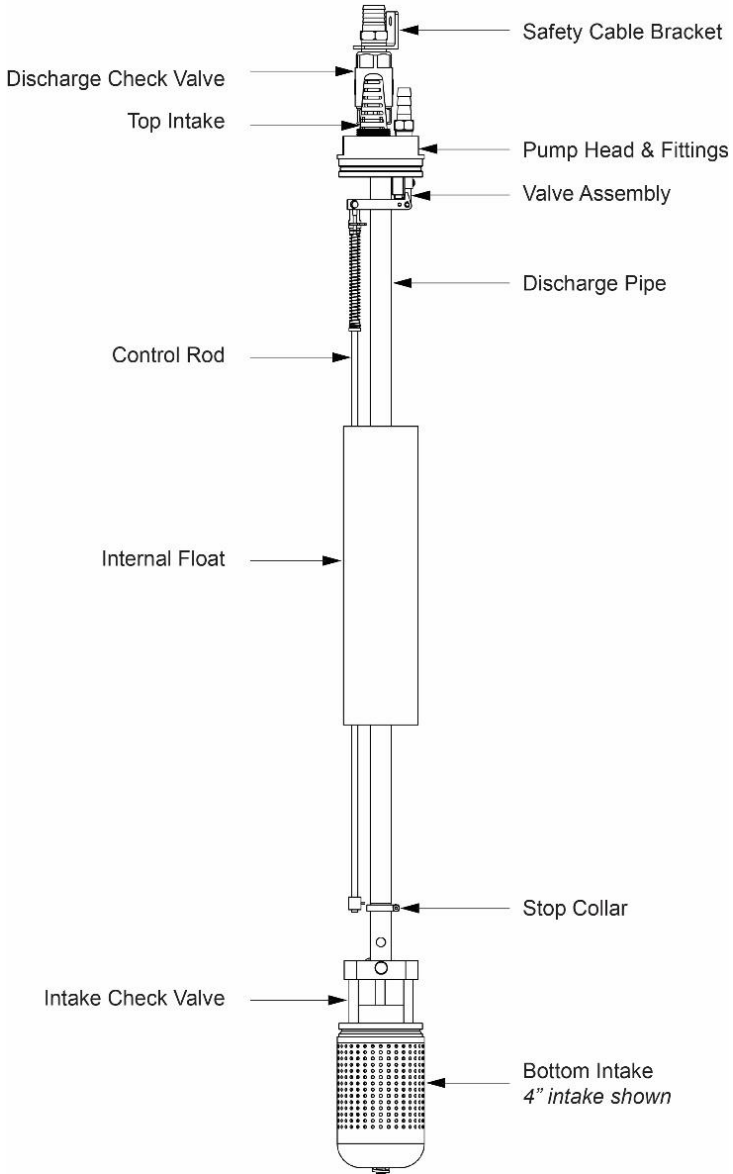


Figure 1-1: Auto Reclaimer 4

## System Components

The AR4 pump series models all share the same internal mechanics and pump options. Figure 1-2 below shows the major components to an AR4.



*\*Housing not shown*

**Figure 1-2:** AR4 model: 86600149 – AR4, SHORT, T&4" B

## Section 2: System Installation

Attach the Air (A), Vent (V), and Discharge (D) hoses/tubing to their appropriate labeled fittings (see Figure 2-1). Ensure all hoses are installed securely and completely. Top filling AR4 pump models have a screened inlet in the Fill (F) port; bottom fill only pumps will have this port plugged.

Attach the pump suspension cable to the safety cable harness and lower pump into well. Suspension cable should be centered with the pump head and not wrapped around any of the fittings or tubing.

Lower the pump into the well so that the appropriate intake(s) becomes submerged below static groundwater conditions.

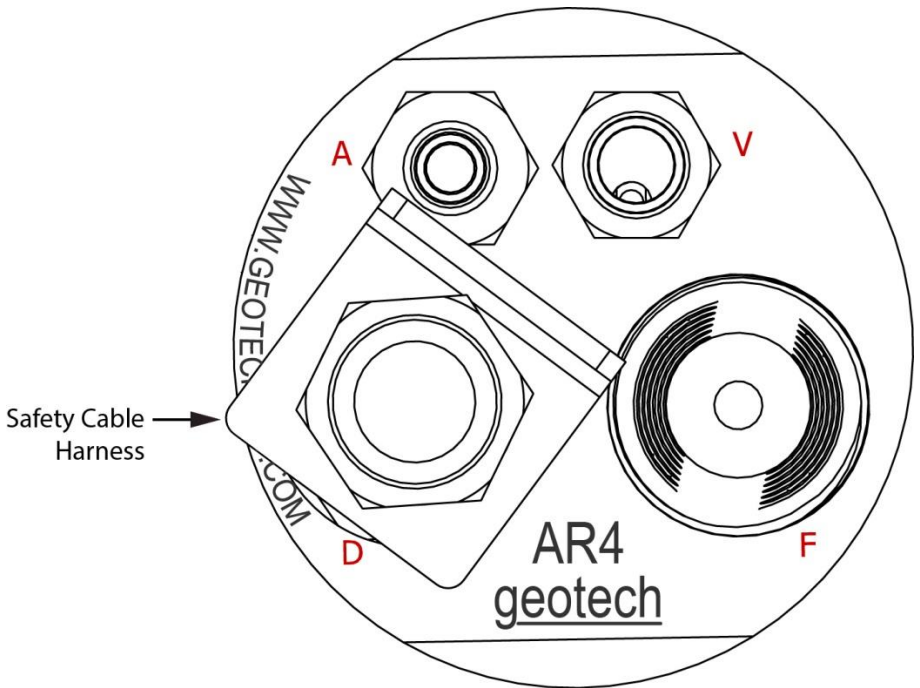


Figure 2-1: Pump Head

## System Schematic

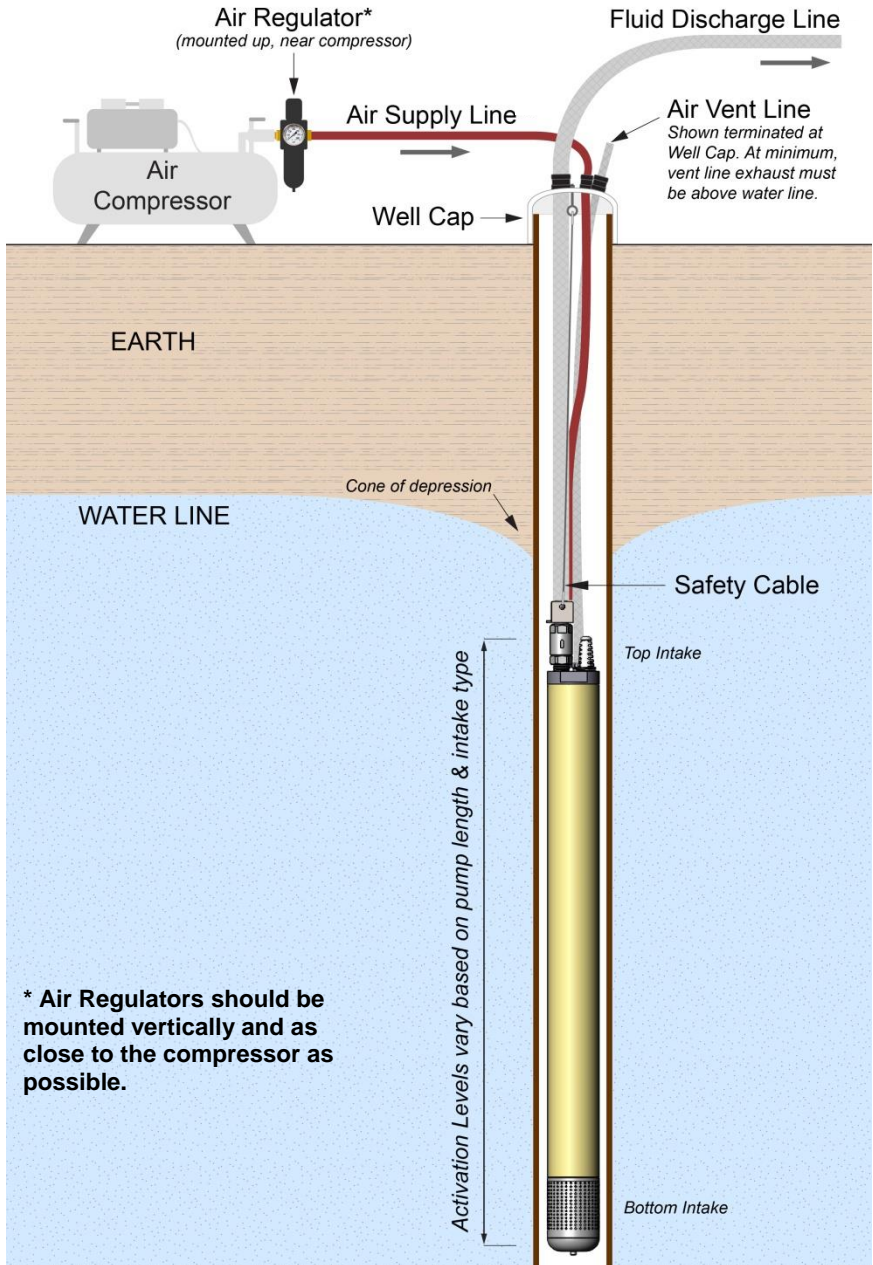


Figure 2-2: Single Pump System Schematic

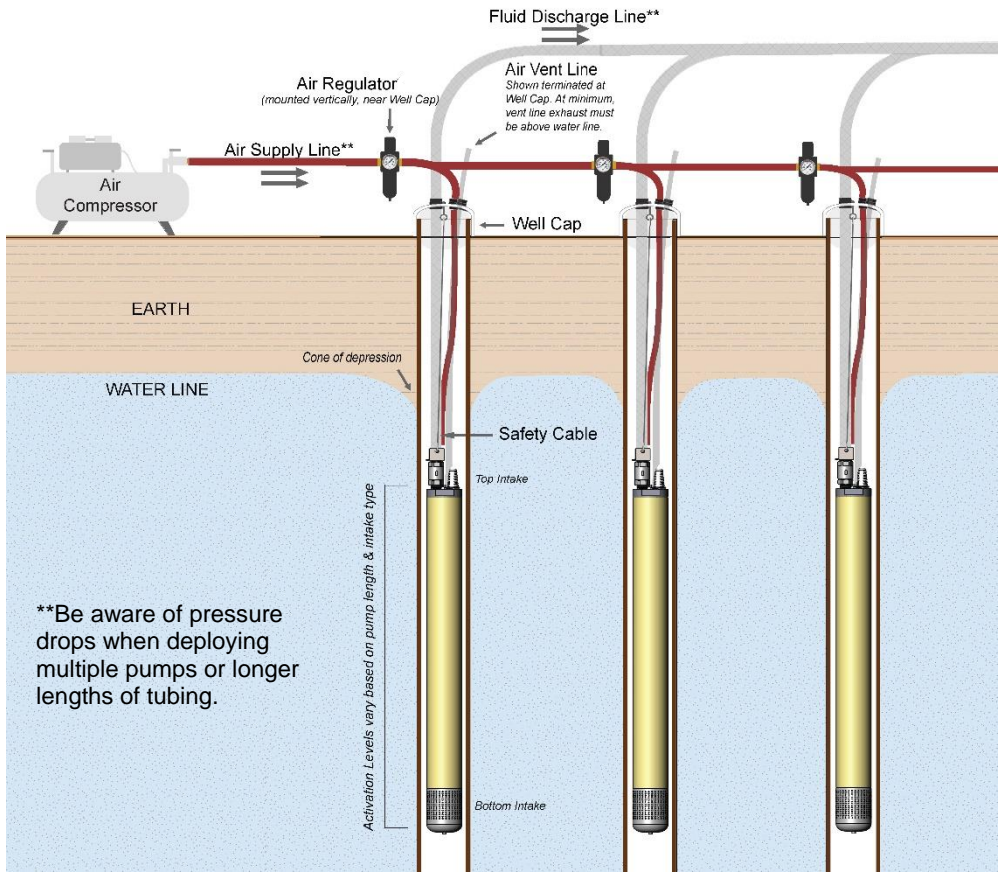
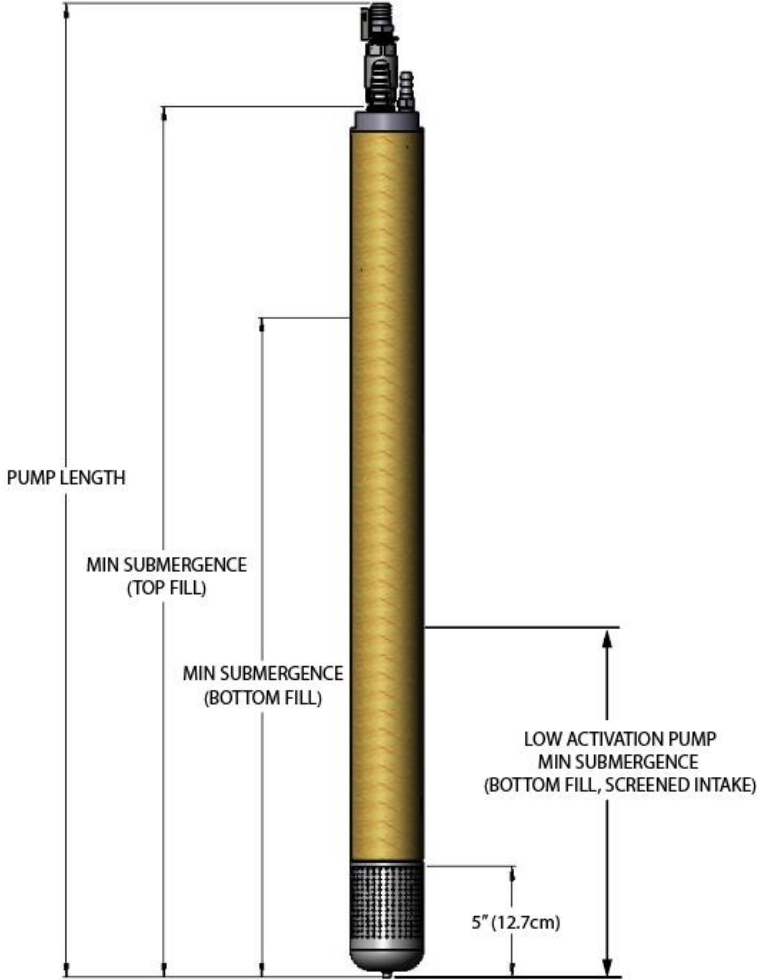


Figure 2-3: System Schematic with Multiple Pumps



## Pump Activation Levels

The AR4 is offered in three pump lengths. Activation levels vary depending on inlet options and pump length. Fluid submergence levels will trip valve mechanics when pumping fluid reaches approximately three quarters the length of the float. Measurements below are shown with a bottom screen. Adjust measurements by reducing 5" (13 cm) if using a flat bottom intake or top fill only AR4. See table and Figure 2-3 below.



PUMP DIMENSIONS	SHORT/LOW ACTIVATION	LONG	EXT
MIN ACTIVATION LEVEL (BOTTOM FILL)	35" (89 cm) / 17" (43 cm)	47" (119 cm)	59" (150 cm)
MIN ACTIVATION LEVEL (TOP FILL)	42.5" (108 cm)	54.5" (138.43 cm)	66.5" (169 cm)
PUMP LENGTH	48" (122 cm)	60" (153 cm)	72" (183 cm)

**Figure 2-3: Submergence Levels for Pump Activation**

# Air Consumption

(See Appendix A for metric conversions)

Depending on site conditions, Figure 2-4 below estimates pump air consumption.

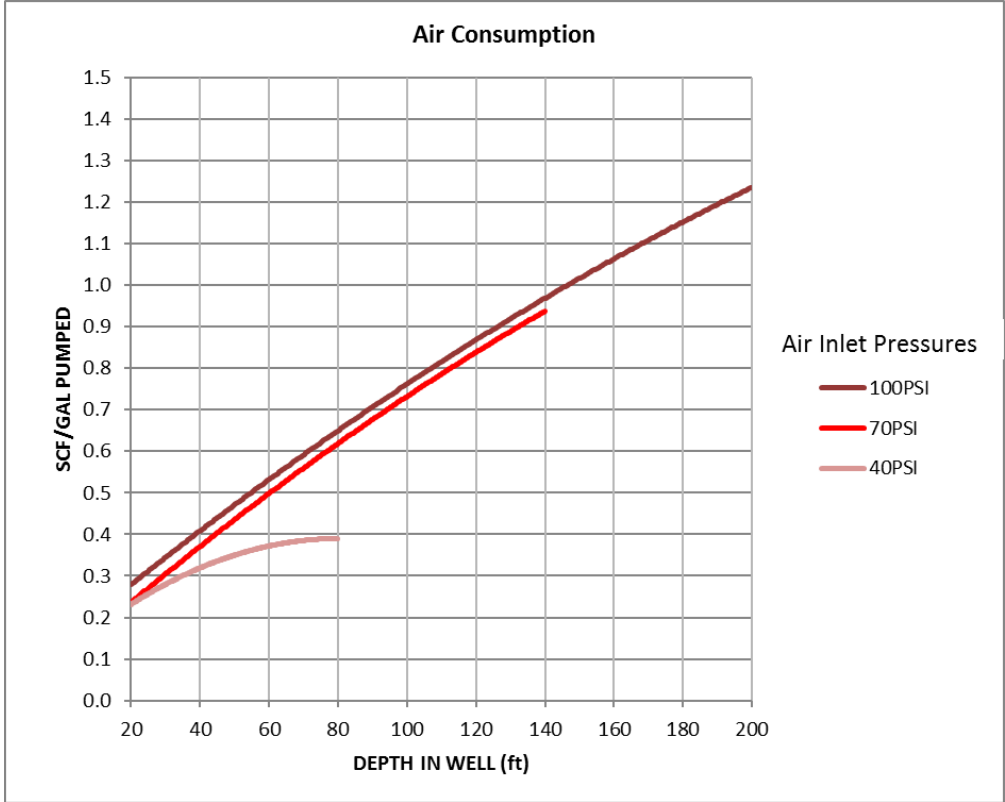
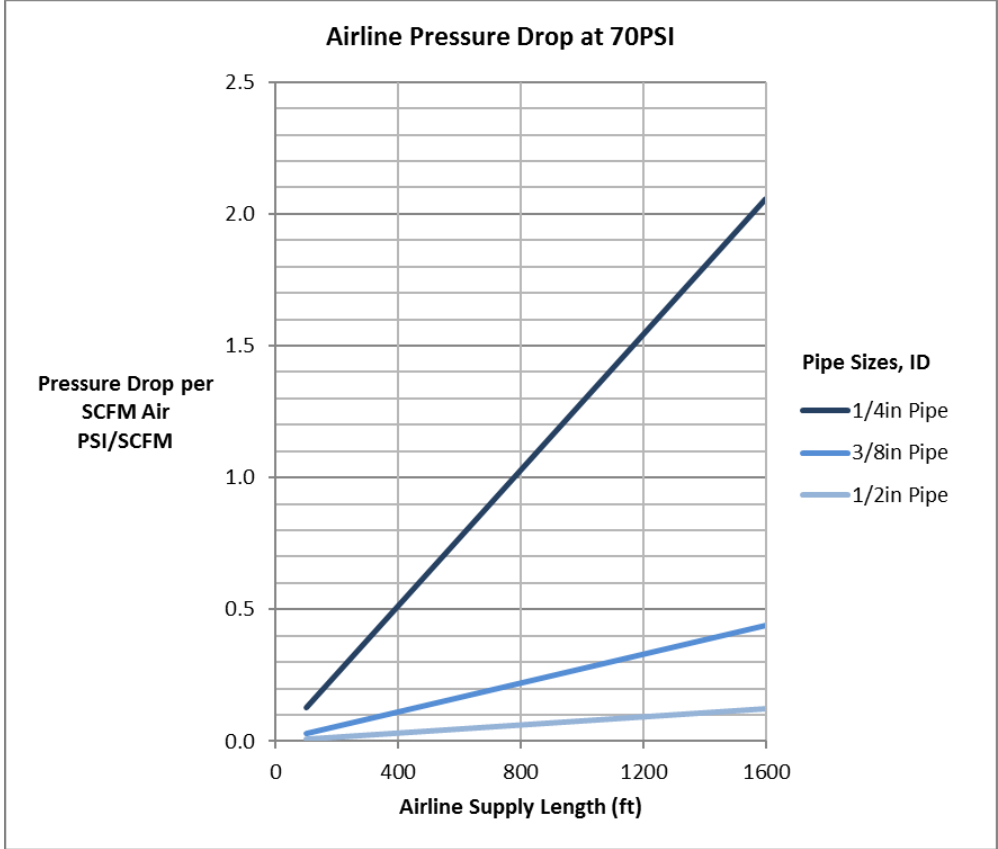


Figure 2-4: Air Consumption

# Airline Supply Pressure Drops

(see Appendix A for metric conversions)  
Airline Supply Pressure Drops (continued)



**Figure 2-6:** Airline Pressure Drop at 70PSI

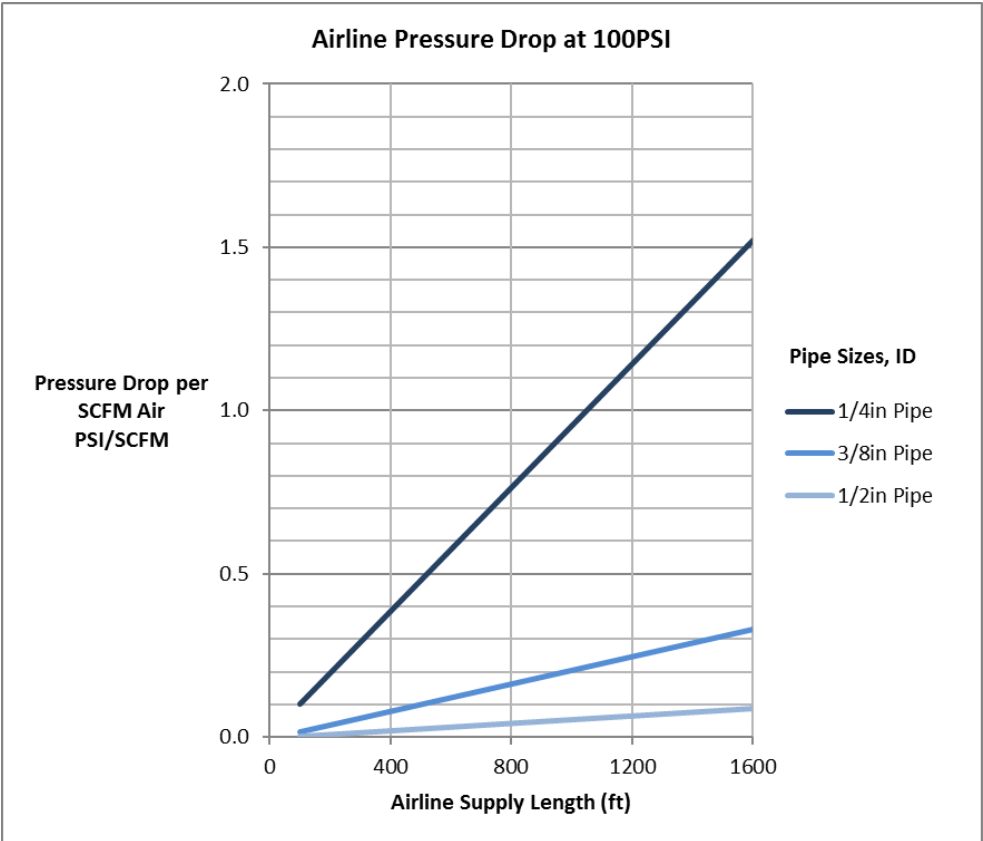


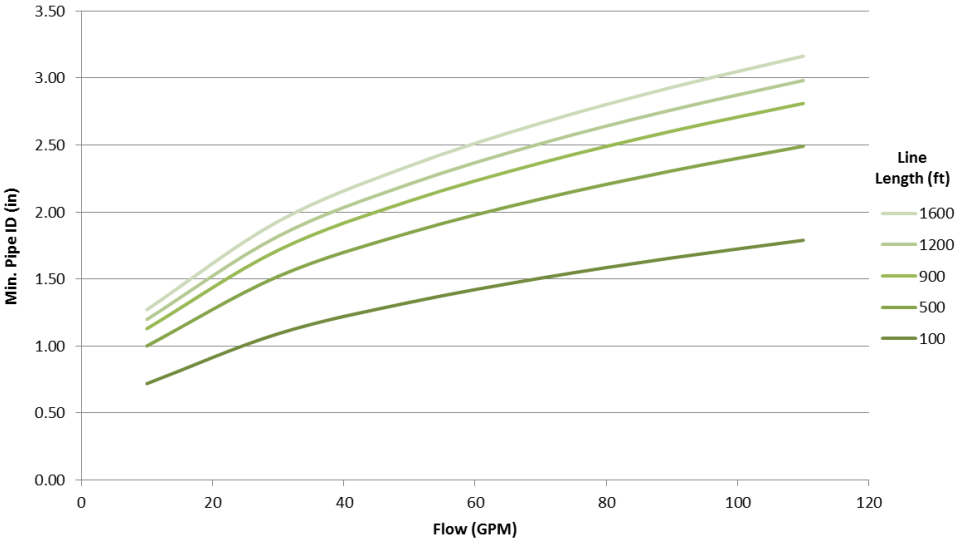
Figure 2-7: Airline Pressure Drop at 100PSI

### Deploying Multiple Pumps

(see Appendix A for metric conversions)

When installing multiple pump lines over extended distances, proper pipe sizing on the discharge side needs to be considered to ensure pressure drop along trunkline does not exceed the pressure available from pump source. Please use Figure 2-7 below as a reference only. Numbers provided were calculated for water flowing through plastic piping.

### Trunkline Sizing (15 psi pressure drop)



**Figure 2-8:** Trunkline Sizing 15PSI Pressure Drop

### Section 3: System Operation

The AR4 pump is lowered in a recovery well so that the fluid intake (top, bottom or dual fill) are sufficiently submerged below the static groundwater level. Provided with a regulated air supply, the pump cyclically fills and empties. As the pump fills, the internal float assembly rises until engaging the control lever that operates the valve mechanism. When the control lever shifts up, the air valve opens and the pump begins to pressurize, closing any inlet check valves and displacing fluid out the discharge pipe. As the water is discharged from the pump, the float assembly lowers, shifting the control lever down and closing the air supply valve and opening the vent valve. The pressurized air exits through the air exhaust tube, allowing the pump to refill and begin a new cycle. This cyclic operation continues automatically as fluid is drawn into the well. Regulated compressed air is utilized in this system as an on demand supply.

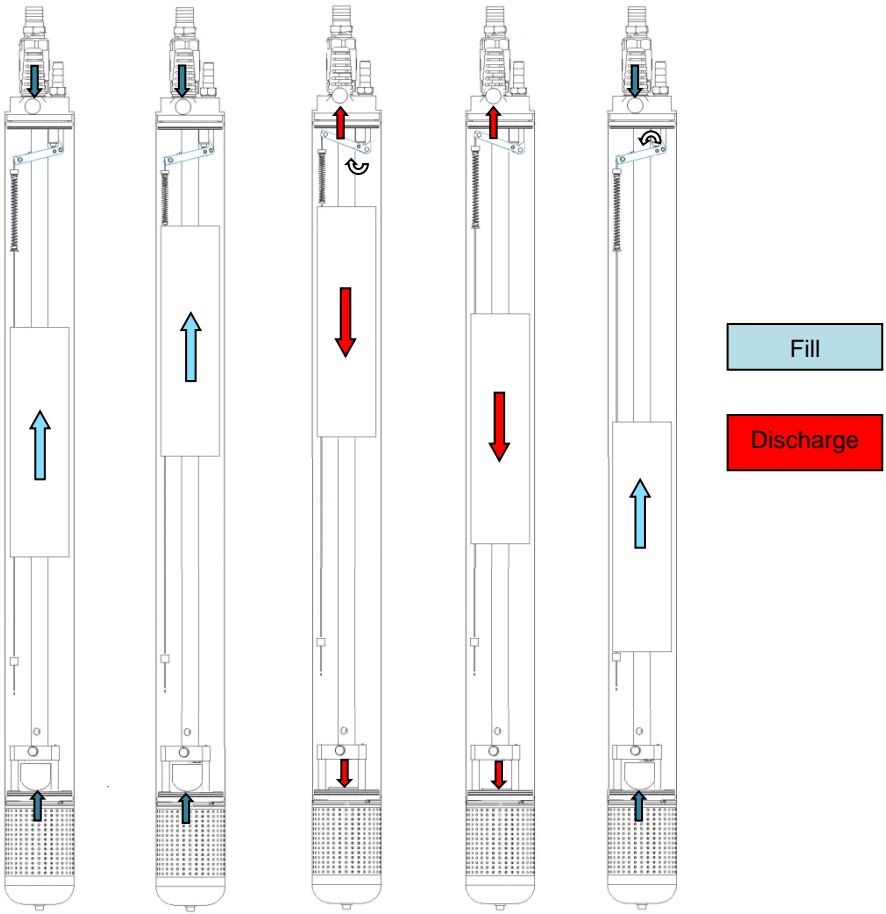


Figure 3-1: Pump cycle

## Section 4: System Specifications

**Table 4-1: Physical Specifications**

Fluid Inlet	Short/Low Activation Pump		Long Pump		Extended Pump	
	Top	Bottom	Top	Bottom	Top	Bottom
Diameter	3.5" (8.9 cm)					
Length	44" (112 cm)	48" (122 cm)	56" (142 cm)	60" (152 cm)	68" (173 cm)	72" (183 cm)
Weight	13.5 lbs (6 kg)		15.6 lbs (7 kg)		17.7 lbs (8 kg)	
Maximum Depth	250' (76.2 m)					
Actuation Level*	42.5" (108 cm)	35" (89 cm) / 17" (43 cm)	54.5" (138.43 cm)	47" (120 cm)	66.5" (169 cm)	59" (150 cm)
Air Pressure	10 - 120 PSI Max (0.7 – 8.5 Kg/cm <sup>2</sup> )					
Air Consumption	0.25 - 1.25 SCF/GAL (1.5-9.5 STD L/Liter)					
Fluids	Landfill leachate, diesel, gasoline, JP1, JP6, #2 heating oils, BTEX, MTBE					
pH Range	4-9					
Max. Temperature	220°F (104°C)					
Min. Density	0.7 SpG					

\* Activation levels shown above reflect activation levels for pumps with a bottom inlet/screen. To determine the activation level for a flat bottom intake, subtract 5" (12.7 cm) from the activation level measurement above.

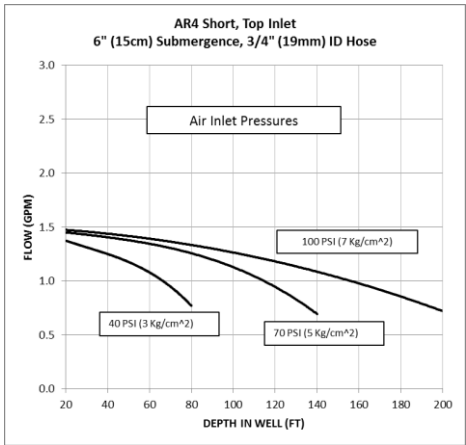
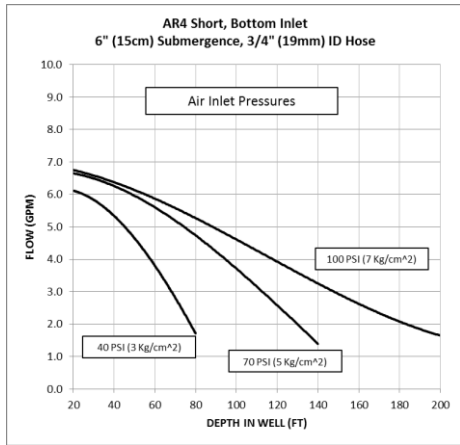
**Table 4-2: Fitting Sizes and Materials**

Tube & Hose Fittings		Pump Materials	
Fitting sizes on pump head		Pump housing/body	FRP
Air - NPT/Hose Barb	3/8" / 3/8"	Pump ends	SS316
Vent - NPT/Hose Barb	3/8" / 1/2"	Bottom Intake	HDPE
Discharge - NPT/Hose Barb	3/4" / 3/4"	Top intake check ball	PTFE
Top Fill - NPT	1"	Bottom intake check ball	HDPE
Tube Fitting Type	Hose barbs or optional Quick Connectors (QCon)	Discharge check ball	PTFE
Tube or Hose Fittings	Brass / Stainless Steel	O-ring seals	FPM
Liquid discharge tubing ID	3/4"	Air inlet check ball	FPM
Air supply tubing ID	3/8"	Vent Seat	FPM
Vent / Air exhaust tubing ID	1/2"	Float	Syntactic Foam
Tubing and Hosing Material	Multiple available - Contact your Geotech Sales Representative	Top Intake Material	PVDF
		Control Rod	PVDF
		Valve Manifold	PVDF

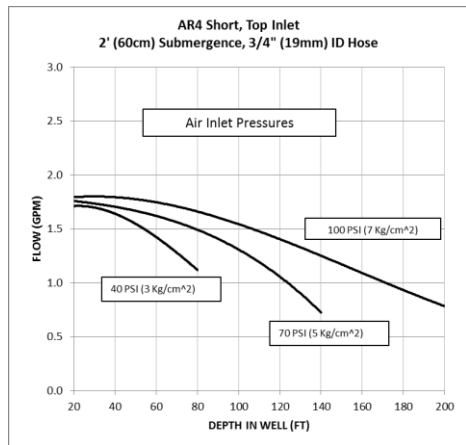
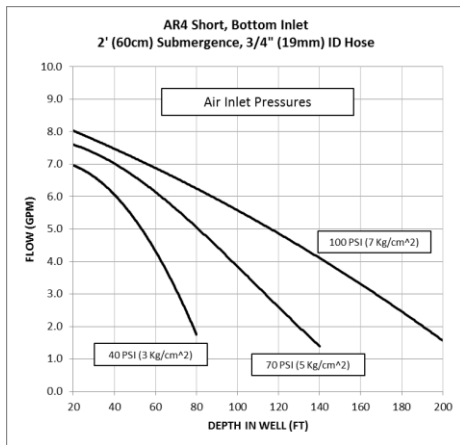
## Performance Curves: AR4 Short Series

(see Appendix A for metric conversions)

Information below is for estimation purposes only. Performance will vary with site specifics. Flow is measured in Gallons Per Minute (GPM).



**Figure 4-1:** AR4 Short Bottom/Top Inlet, 6" (15 cm) Submergence, 3/4" (19 mm) ID Hose in GPM



**Figure 4-2:** AR4 Short Bottom/Top Inlet, 2' (60 cm) Submergence, 3/4" (19 mm) ID Hose in GPM



Performance Curves: AR4 Short Series (continued)

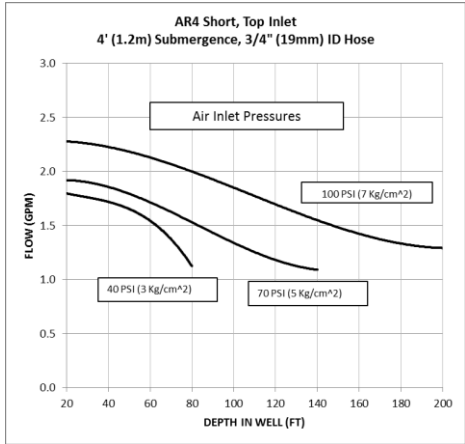
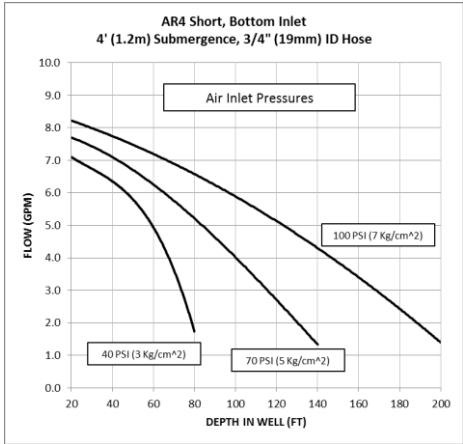


Figure 4-3: AR4 Short Bottom/Top Inlet 4' (1.2 m) Submergence, 3/4" (19 mm) ID Hose in GPM

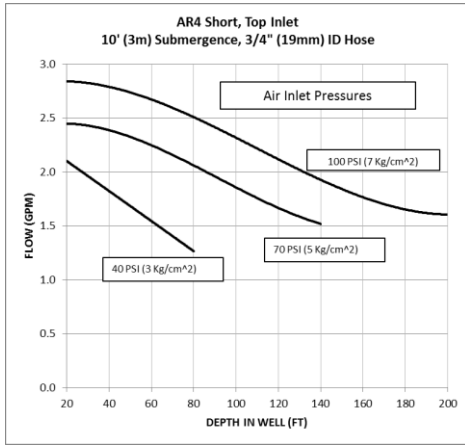
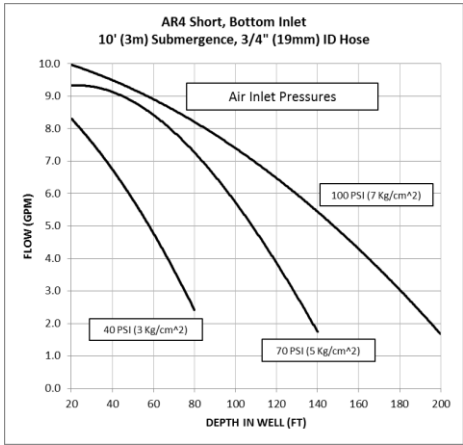
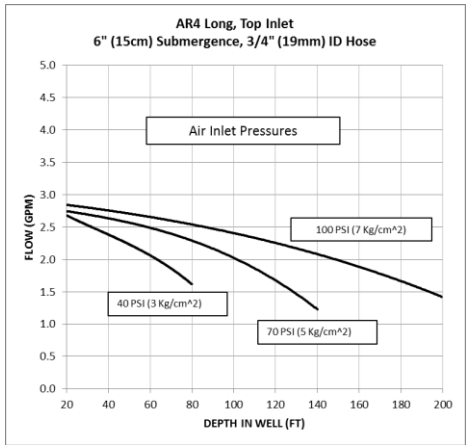
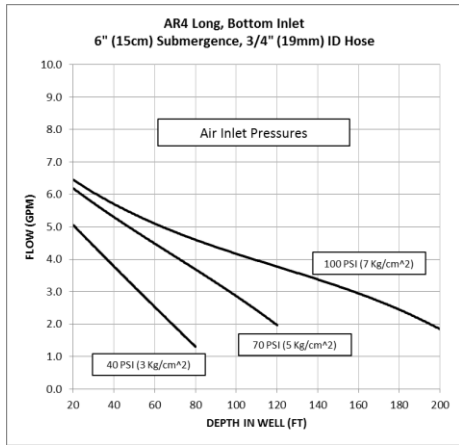


Figure 4-4: AR4 Short Bottom/Top Inlet 10' (3 m) Submergence, 3/4" (19 mm) ID Hose in GPM

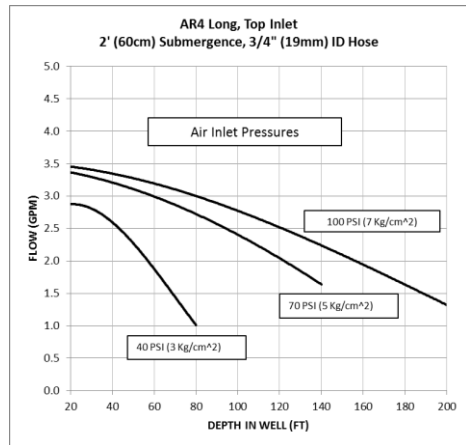
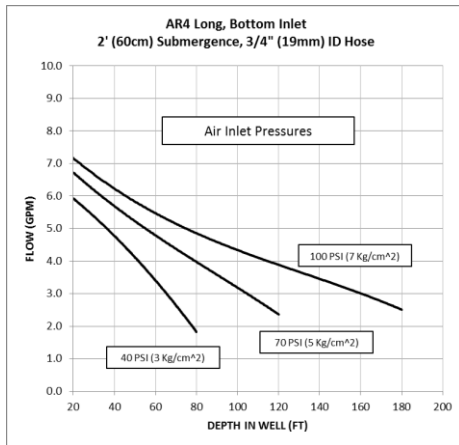
## Performance Curves: AR4 Long Series

(see Appendix A for metric conversions)

Information below is for estimation purposes only. Performance will vary with site specifics. Flow is measured in Gallons Per Minute (GPM).



**Figure 4-5: AR4 Long Bottom/Top Inlet 6" (15 cm) Submergence, 3/4" (19 mm) ID Hose in GPM**



**Figure 4-6: AR4 Long Bottom/Top Inlet 2' (60 cm) Submergence, 3/4" (19 mm) ID Hose in GPM**

Performance Curves: AR4 Long Series (continued)

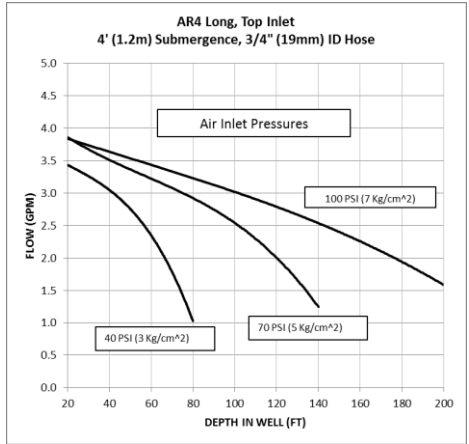
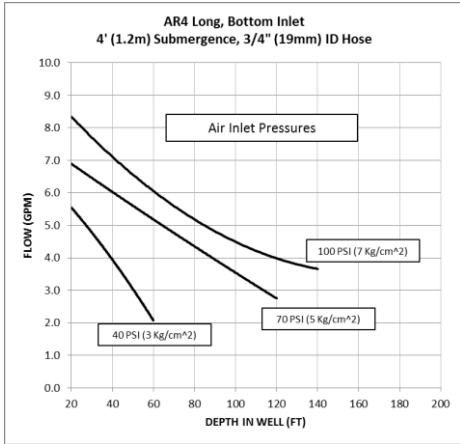


Figure 4-7: AR4 Long Bottom/Top Inlet 4' (1.2 m) Submergence, 3/4" (19 mm) ID Hose in GPM

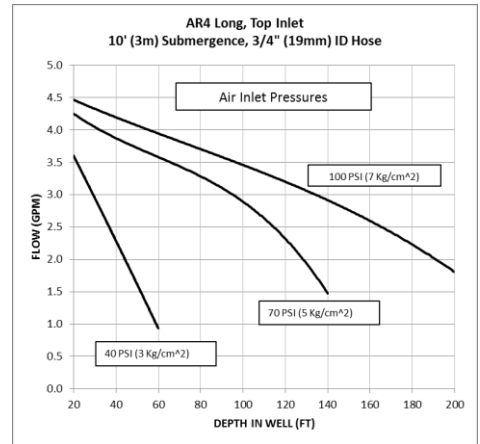
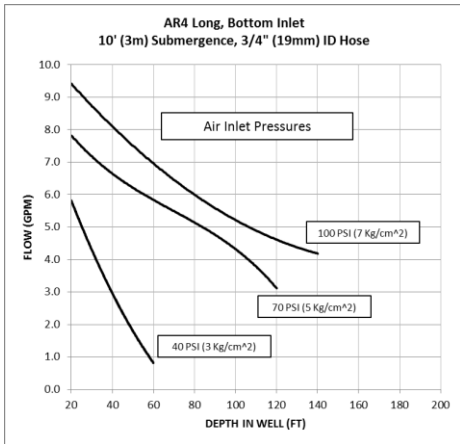


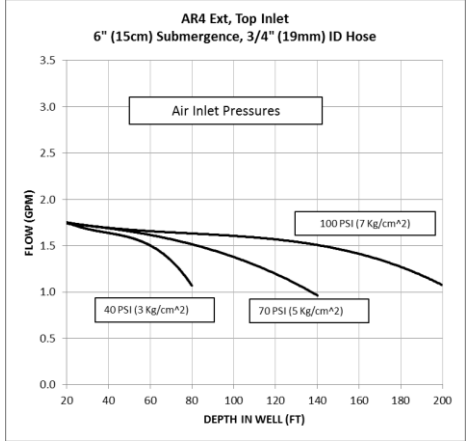
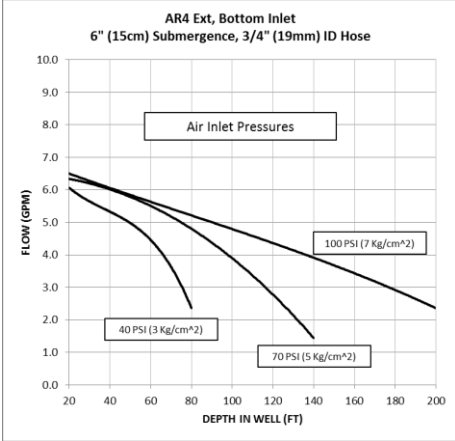
Figure 4-8: AR4 Long Bottom/Top Inlet 10' (3 m) Submergence, 3/4" (19 mm) ID Hose in GPM

## Performance Curves: AR4 EXT Series

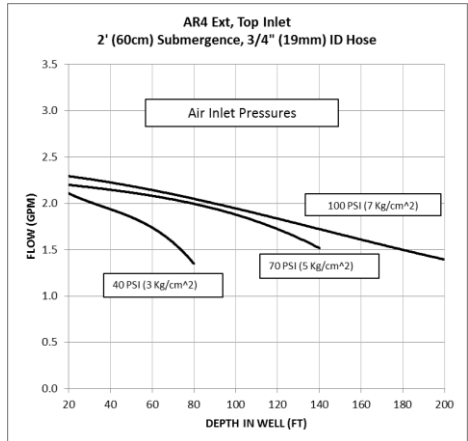
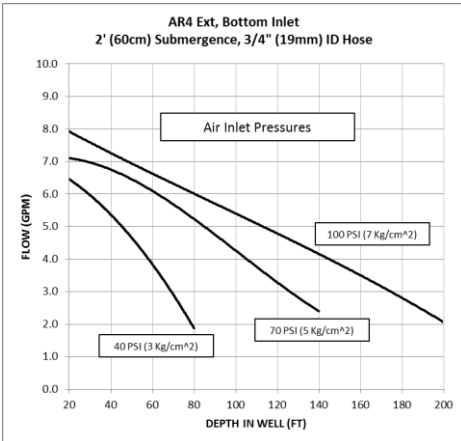
(see Appendix A for metric conversions)

The EXT pump requires less maintenance compared to other models, cycles more fluid volume per duty cycle, and has a longer service life.

Information below is for estimation purposes only. Performance will vary with site specifics. Flow is measured in Gallons Per Minute (GPM).

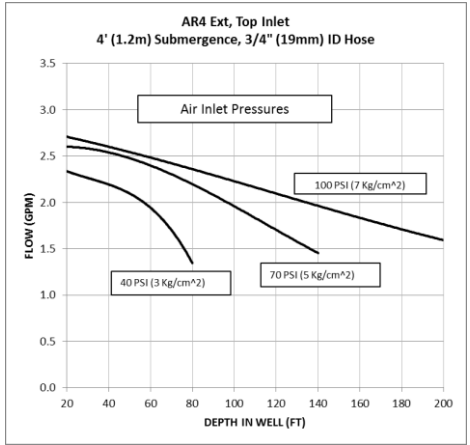
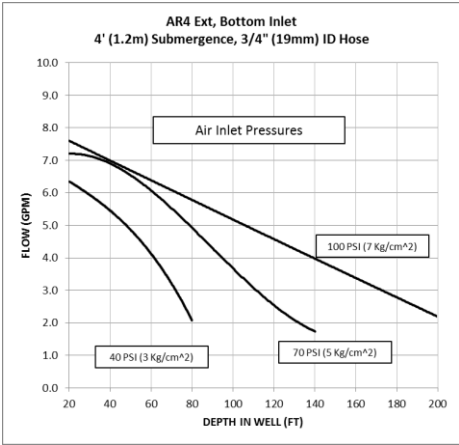


**Figure 4-9:** AR4 EXT. Bottom/Top Inlet 6" (15 cm) Submergence, 3/4" (19 mm) ID Hose in GPM

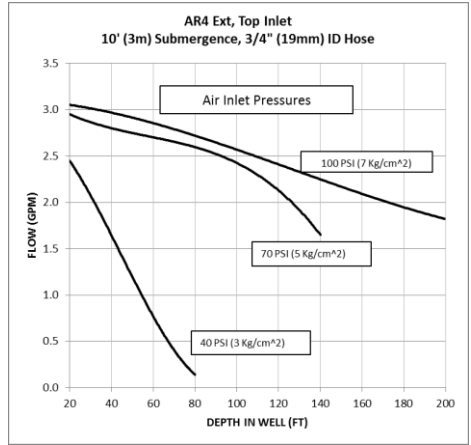
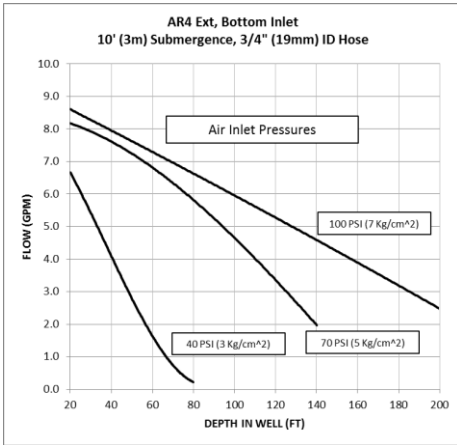


**Figure 4-10:** AR4 EXT. Bottom/Top Inlet 2' (60 cm) Submergence, 3/4" (19 mm) ID Hose in GPM

Performance Curves: AR4 EXT Series (continued)



**Figure 4-11:** AR4 EXT. Bottom/Top Inlet 4' (1.2 m) Submergence, 3/4" (19 mm) ID Hose in GPM



**Figure 4-12: AR4 EXT. Bottom/Top Inlet 10' (3 m) Submergence, 3/4" (19 mm) ID Hose in GPM**

## Section 5: Replacement Parts

### AR4 Replacement Parts List

ITEM	DESCRIPTION	PART NO.	ITEM	DESCRIPTION	PART NO.
1	HOSEBARB,SS316,3/4" X 3/4"MPT	16600218	20	FLOAT,SYNTACTIC,AR4	26600234
2	CHECK VALVE,SS316,PTFE,3/4"FPT	16600268	21	COLLAR,CONTROL ROD,AR4	26600275
3	NIPPLE,SS316,3/4"MPT X 1-1/2"	16600267	22*	ORING,#007,VITON	16600301
4	HOSEBARB,SS316,1/2" X 3/8"MPT	16600217	23	PIN,CLEVIS,3/8",SS316	16600303
5	HOSEBARB,SS316,3/8" X 3/8"MPT	16600213	24	WELDMENT,RETAINER,LOWER INTAKE,AR4	56600079
6*	SCREEN,INLET,TOP,PVDF,AR4	*26600252	25*	DRAIN,FLAT BOTTOM,SS316,3/8",AR4	26600259
7*	PLUG,SQUARE HEAD,SS316,1"NPT	16600298	26*	PLUG,CHECK,LOWER INTAKE,HDPE,AR4	26600245
8*	BALL,PTFE,7/8"	*16600098	27*	WELDMENT,SUPPORT,SEAT,LOWER INTAKE,AR4	56600080
9*	WELDMENT,HEAD,PIPE,SHORT, AR4	56600078	28	SCREW,VITON,SS316,1/4-20 X 1/2",SELF SEALING,SHCS	16600367
*	WELDMENT,HEAD,PIPE,LONG, AR4	56600081	29*	WELDMENT,SCREEN,DOME,LOWER INTAKE, AR4	16600293
*	WELDMENT,HEAD,PIPE,EXT, AR4	56600082	30*	WASHER,LOCK,SS316,3/8"	16600300
10	HARNES, SAFETY,AR4	56600084	31*	SCREW,SS6,1/4-20 X 3/8",SHCS	16600297
11	ORING,#234, VITON, AR4	16600361	32*	HOUSING,AR4,FRP.SHORT	56600086
12	ASSEMBLY,VALVE,AR4	56600083	*	HOUSING,AR4,FRP.LONG	56600087
13*	ROD,CONTROL,PVDF,SHORT,AR4	26600272	*	HOUSING,AR4,FRP.EXTENDED	56600088
*	ROD,CONTROL,PVDF,LONG,AR4	26600279	*	HOUSING,SS6,SHORT,AUTO-REC,AR4	26600261
*	ROD,CONTROL,PVDF,EXTENDED,AR4	26600280	*	HOUSING,SS6,LONG,AUTO-REC,AR4	26600262
*	ROD,CONTROL,PVDF,SHORT,LOW ACTIVATION, AR4	26600285	*	HOUSING,SS6,EXT,AUTO-REC,AR4	26600263
14	PIN,HITCH,MOD.,SS316,AR4	26600276	33*	CAP,LOWER,SS316,BLANK,AR4	26600248
15	LINK,CONTROL ROD,AR4	26600274	34*	CAP,INTAKE,LOWER,SS6,FLAT BOTTOM,AR4	26600253
16	PIN,SS316,COTTER,FITS 1/4" TO 3/8"	16600364	35*	WASHER,LOCK,SS316,1/4"	16600295
17	SCREW,SS316,8-32 X 1",SHCS	16600274	36	COLLAR,STOP,DELRLN,FLOAT,AR4	26600283
18	SPRING,CONTROL ROD, SS6, AR4	16600321			
19	STOP,SPRING,SS316,AR4	26600232	**	Optional Quick Connectors (QCon) Contact your Geotech Sales representative	

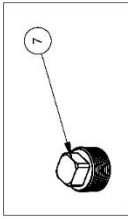
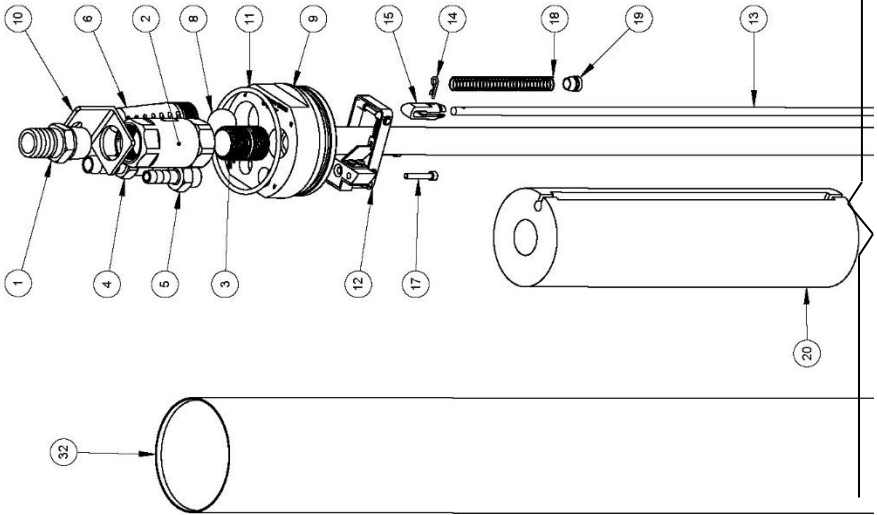
\* Parts not included with all pump models

### AR4 Pump Model List

DESCRIPTION	PART NO.	DESCRIPTION	PART NO.
AUTO RECLAIMER, 4", SHORT, T&4"B	86600149	AUTO RECLAIMER, 4", LONG, 4"B	86600158
AUTO RECLAIMER, 4", SHORT, T&B	86600152	AUTO RECLAIMER, 4", LONG, B	86600159
AUTO RECLAIMER, 4", SHORT, T	86600153	AUTO RECLAIMER, 4", EXT, T&4"B	86600160
AUTO RECLAIMER, 4", SHORT, 4"B	86600154	AUTO RECLAIMER, 4", EXT, T&B	86600161
AUTO RECLAIMER, 4", SHORT, B	86600151	AUTO RECLAIMER, 4", EXT, T	86600162
AUTO RECLAIMER, 4", LONG, T&4"B	86600155	AUTO RECLAIMER, 4", EXT, 4"B	86600163
AUTO RECLAIMER, 4", LONG, T&B	86600156	AUTO RECLAIMER, 4", EXT, B	86600164
AUTO RECLAIMER, 4", LONG, T	86600157		

\* Contact your Geotech Sales representative for custom AR4 pump lengths and options

# Replacement Parts Diagram

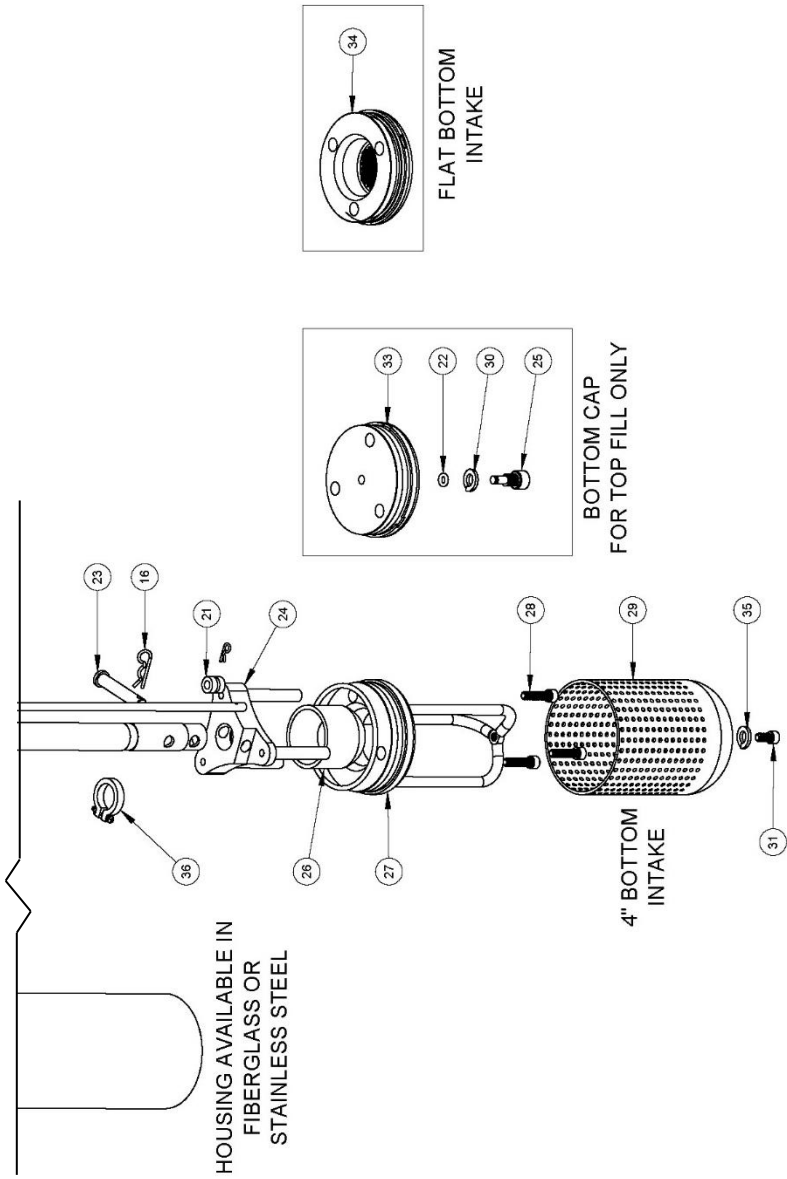


PLUG FOR  
BOTTOM INTAKE ONLY



\*\*OPTIONAL QUICK  
CONNECTS (QCON)





## Section 6: System Maintenance

### Maintenance Schedule

It is recommended that the AR4 is pulled from the well annually for inspection and cleaning to maximize efficiency and pump performance. Depending on the site conditions routine maintenance may be needed on a more frequent basis.

Disassemble pump by removing the bottom cap and housing. Internal components can be removed from center pipe with standard hex keys. Further disassembly instruction can be found in the next section.

### Maintenance Operations

- Clean any residue or sediment build up on float, housing, and center pipe. Reducing friction or “sticky” spots along the float’s travel can be beneficial to your pumps performance.
- Ensure that the control lever shifts smoothly between up and down positions. Remove O-rings and check balls, and inspect check seat for unwanted buildup or debris.
- Inspect inlet and the discharge check valves for wear spots and/or sediment build up.
- Apply a calcium sulfonate grease or similar to all O-ring bearing surfaces of valve assembly.

### Required Tools

- 3/16” Hex Key Driver used at lower cap and 4” screen removal
- 9/64” Hex Key Driver used at Valve
- 1/4” Hex Nut driver used at Hose clamps
- Cleaning scrub brush
- Center pipe ID brush

### Supplies\*

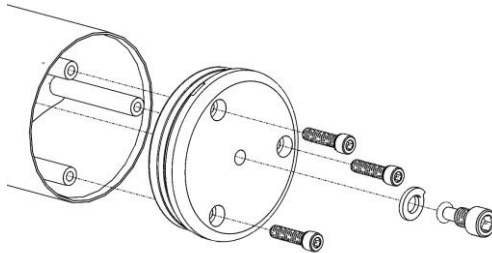
- Anti-seize used on Lower intake bolt threads
- Loctite 242 used on Valve mounting bolts
- Detergent for general purpose cleaning
- WD40 for lubrication
- Heavy duty detergent for all descaling of internal components
- PTFE Tape for all pipe threads
- Calcium sulfonate grease at O-ring contact points

\*Available from your Geotech representative

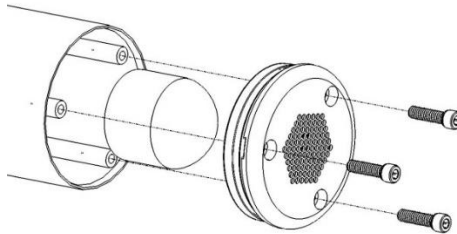
## Disassembly Instructions

### Housing and Bottom Cap

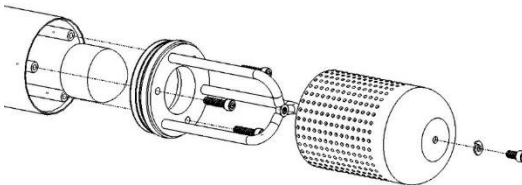
Use a 3/16" hex key to remove the bottom cap from the pump by unscrewing three 1/4" socket head cap screws (SHCS) from the lower end of the pump (4" screened bottom intake pumps will need to remove an additional screw (see Figure 7-1 through 7-3). Top fill only pumps have a 3/8" SHCS drain plug that can be removed to empty the pump. It is strongly encouraged to drain the pump prior to removing cap. Bottom fill pumps can be drained by lifting check plug from bottom cap seat. After the pump is emptied and bottom cap unfastened, lightly pull the cap away from the bottom housing. Blank bottoms and flat screen bottom caps have three indents where screwdriver or tool can be used to assist bottom cap free from housing. Once the cap is pulled away, the housing can be taken off by pulling/twisting away from pump head. Bottom cap styles are interchangeable.



**Figure 7-1:** Blank Bottom Cap



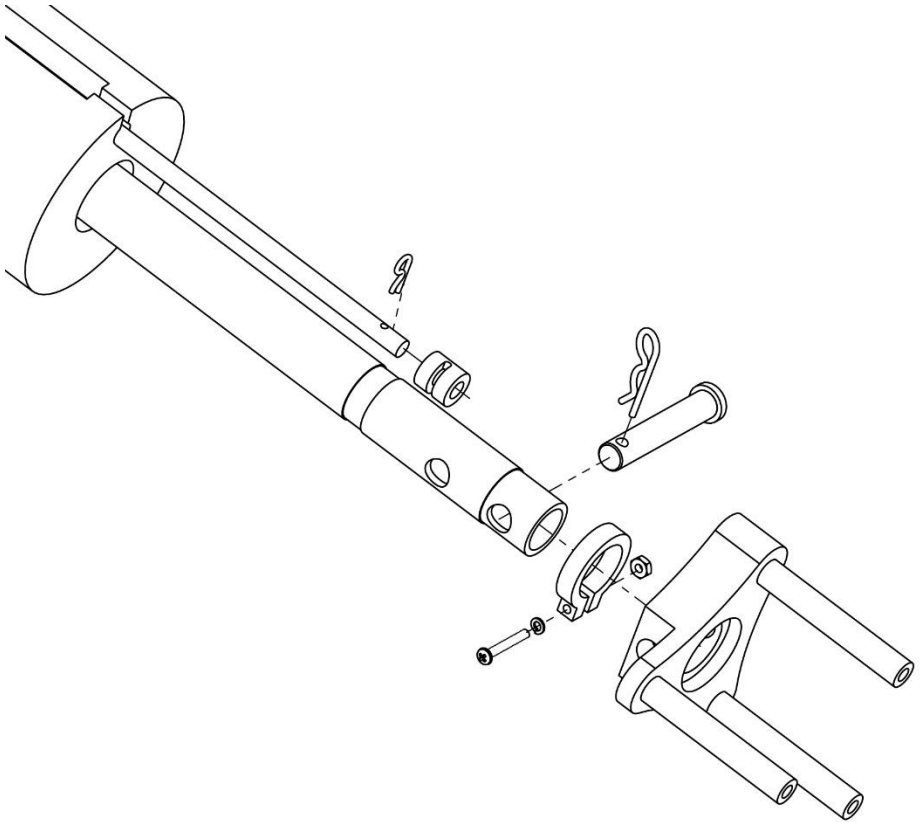
**Figure 7-2:** Flat Bottom Intake



**Figure 7-3:** 4" Screened Intake

## Retainer and Float

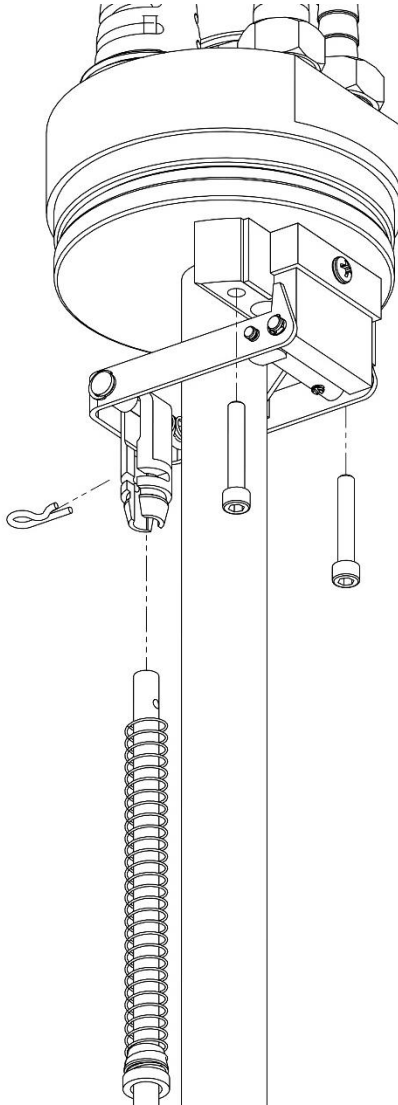
Remove the hitch clip from the clevis pin holding the check plug retainer. Use a pair of small pliers to pull the shortened cotter pin securing the lower control rod collar. Remove the stop collar, springs, and floats. When the float has been removed, care must be taken to not bend the control rod or stress the control rod link.



**Figure 7-4:** Removing Checkplug Retainer and Float

## Control Rod/ Valve Assy.

The control rod is attached to the valve link using a shortened hitch pin. Use a pair of pliers to remove the cotter pin and remove the control rod from the valve link. The link can be removed from the valve assembly simply pushing it off the spring shaft. The valve detaches from the pump head by removing two bolts using a 9/64" hex key.



**Figure 7-5:** Removing Control Rod & Manifold assembly

## Section 7: System Troubleshooting

### Pump discharges minimal or no fluid to the surface

**Problem**

Not enough air pressure is being supplied to the pump.

**Solution**

Ensure the air pressure is adequate for the pump depth. Minimum operating pressure-depth ratio: 0.50 PSI/ft. is a good estimate to start with.

**Problem**

The bottom and/or upper fluid intake screen is blocked.

**Solution**

Clear the screen(s) of all debris.

**Problem**

The air, vent, and/or discharge hoses/tubing are kinked or blocked.

**Solution**

Clear the vent hose of all obstruction, replace if kinked.

**Problem**

The center pipe, float and valve have sediment buildup causing “sticky” high friction spots.

**Solution**

Pull AR4 and perform a general maintenance cleaning.

**Problem**

The fluid density being pumped is too light.

**Solution**

Geotech’s AR4 is rated for fluid densities as low as 0.70 SpG. For pumping fluid densities less than 0.70 SpG a custom float is required. Contact a Geotech Technical sales representative for more information.

**Problem**

There is not enough fluid in well, or pump is not low enough to trigger the minimum activation levels.

**Solution**

Use a water level meter to determine fluid depths in wells and reference Section 2 AR4 System installation.

**Problem**

Interference or damage to seat is preventing proper seal at the inlet check valves. Recovery fluid is exiting pump through inlets as opposed to discharge line.

**Solution**

Inspect all check valves for interference between the check “plug” and seat. Replace or refinish check seats if necessary.

## **Air in discharge line during cycle**

### **Problem**

The pressure-depth ratio is too high.

### **Solution**

Ensure air pressure is adequate for the pump depth (.50 PSI per foot of depth). Having a high pressure-depth ratio will increase recovery time, but decrease air consumption efficiency.

## **Continuous air coming out of vent**

### **Solution**

- Inspect that when valve lever is in the up position there is a gap between the valve and manifold, and ensure the vent valve is seated properly against the O-ring.
- O-rings are damaged in valve assembly. Inspect O-rings and check ball inside manifold to ensure no cracks, tears, or damage. Replace as needed.

## **Springs in the valve assembly are not properly seated**

### **Solution**

Visually inspect the springs. Clean anything that could be caught in the springs and make sure they are properly positioned.

If you are experiencing other problems than mentioned above, please call Geotech Technical Support for immediate assistance, (800) 833-7958.

# Appendix A –System Specifications - Metric

## Performance Curves: AR4 Short Series - Metric

Information below is for estimation purposes only. Performance will vary with site specifics. Flow is measured is Liters Per Minute (LPM)

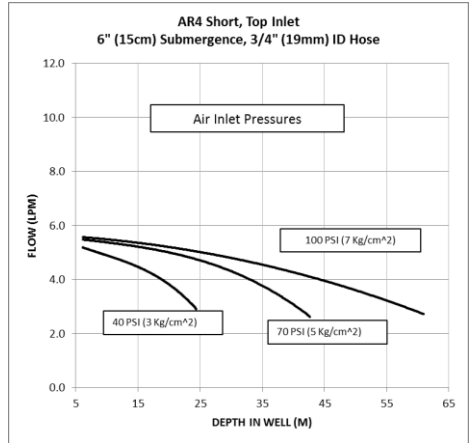
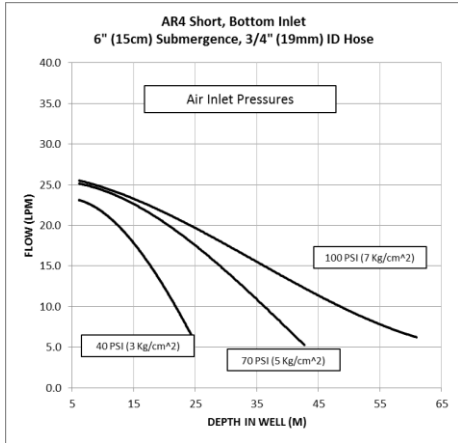


Figure A-1: AR4 Short Bottom/Top Inlet 6" (15 cm) Submergence, 3/4" (19 mm) ID Hose in LPM

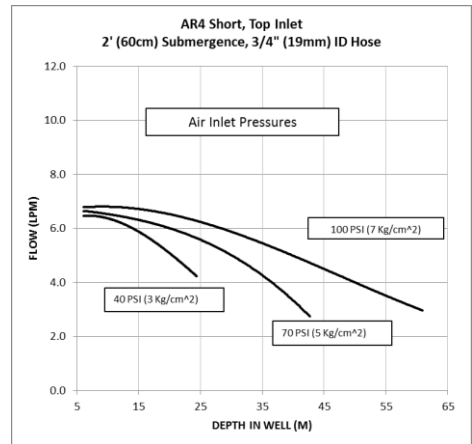
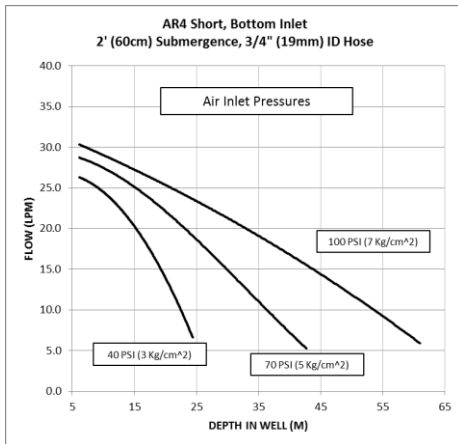
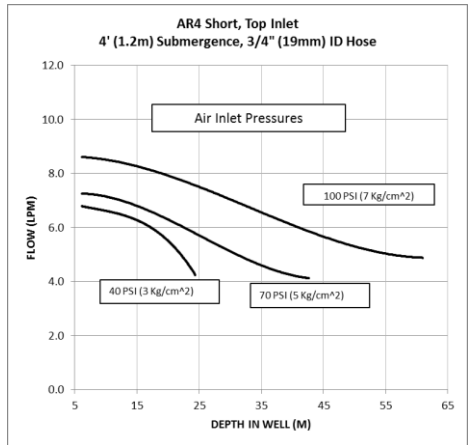
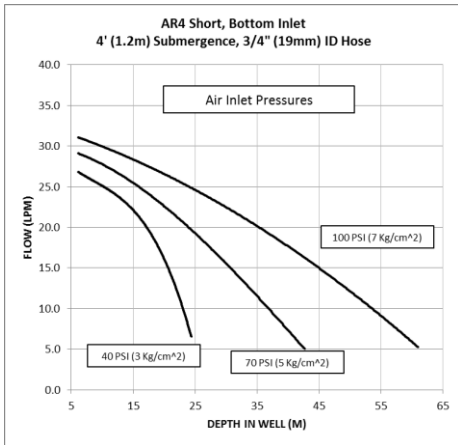


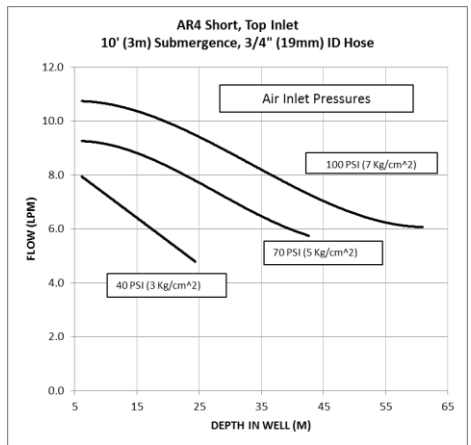
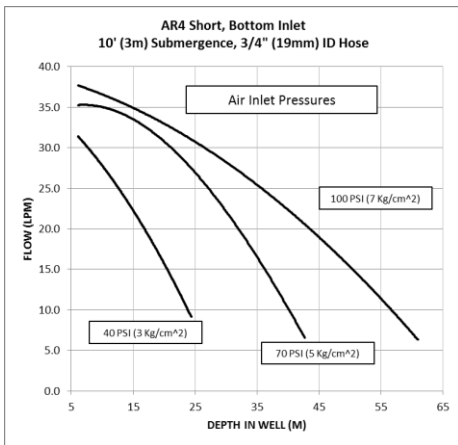
Figure A-2: AR4 Short Bottom/Top Inlet 2' (60 cm) Submergence, 3/4" (19 mm) ID Hose in LPM



Performance Curves: AR4 Short Series – Metric (continued)



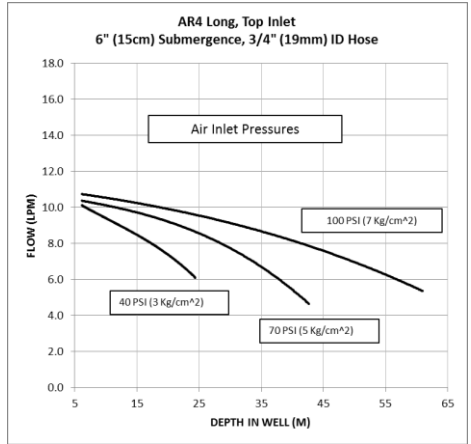
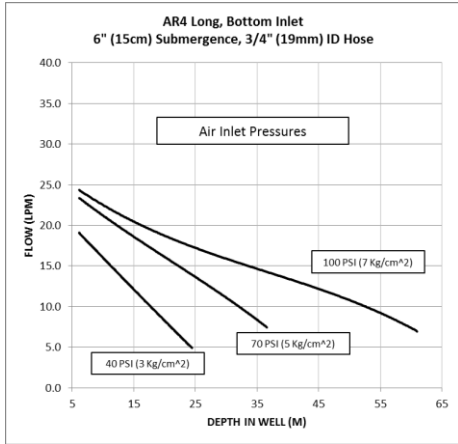
**Figure A-3:** AR4 Short Bottom/Top Inlet 4' (1.2 m) Submergence, 3/4" (19 mm) ID Hose in LPM



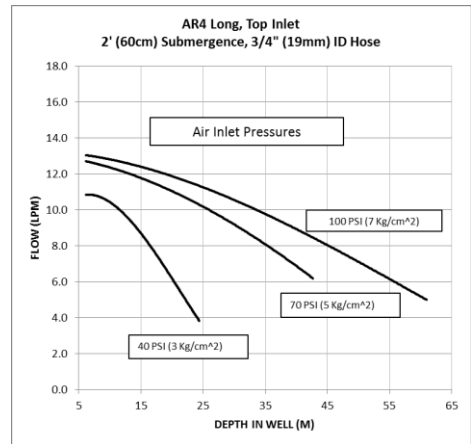
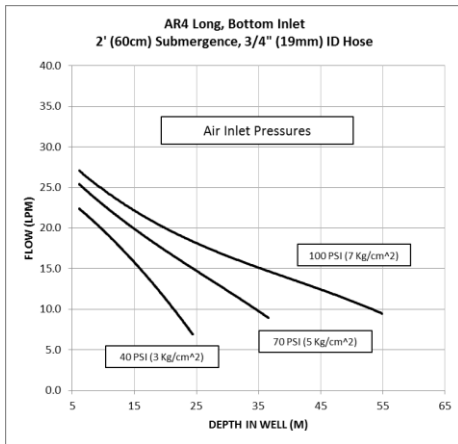
**Figure A-4:** AR4 Short Bottom/Top Inlet 10' (3 m) Submergence, 3/4" (19 mm) ID Hose in LPM

## Performance Curves: AR4 Long Series - Metric

Information below is for estimation purposes only. Performance will vary with site specifics. Flow is shown in Liters Per Minute (LPM).

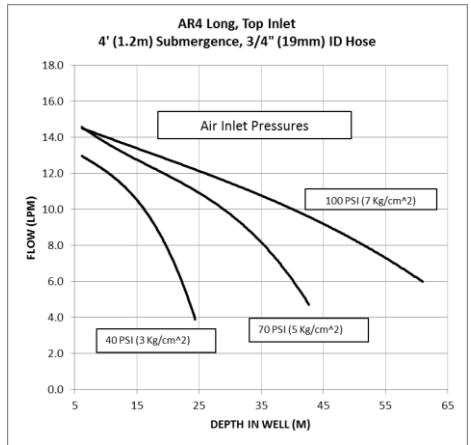
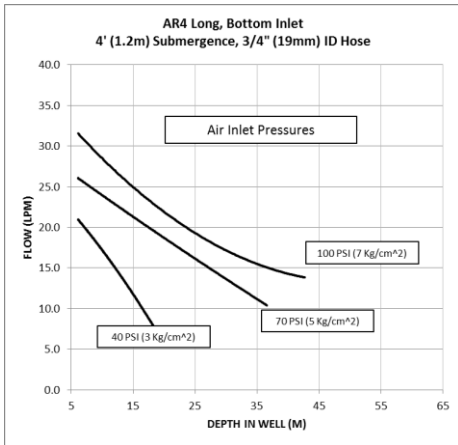


**Figure A-5:** AR4 Long Bottom/Top Inlet 6" (15 cm) Submergence, 3/4" (19 mm) ID Hose in LPM

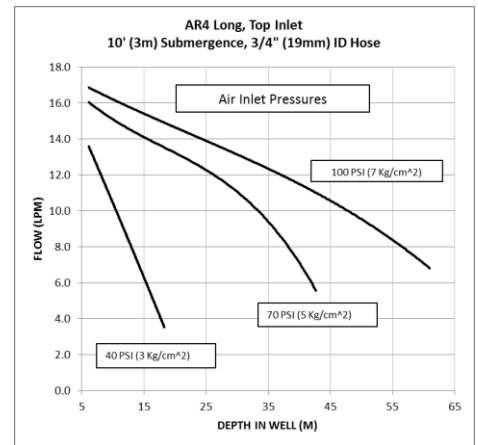
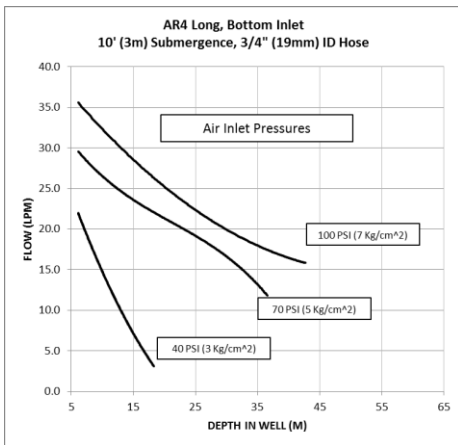


**Figure A-6:** AR4 Long Bottom/Top Inlet 2' (60 cm) Submergence, 3/4" (19 mm) ID Hose in LPM

Performance Curves: AR4 Long Series – Metric (continued)



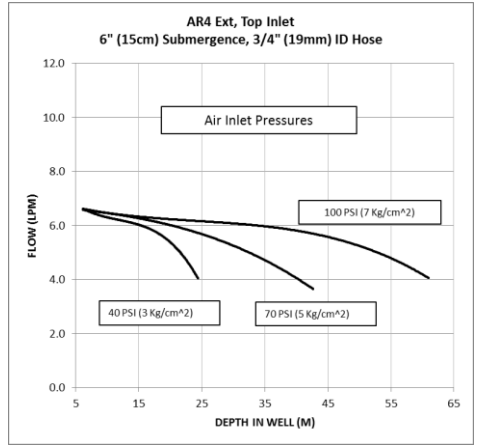
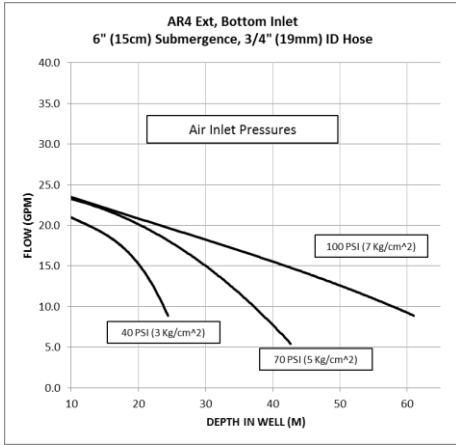
**Figure A-7:** AR4 Long Bottom/Top Inlet 4' (1.2 m) Submergence, 3/4" (19 mm) ID Hose in LPM



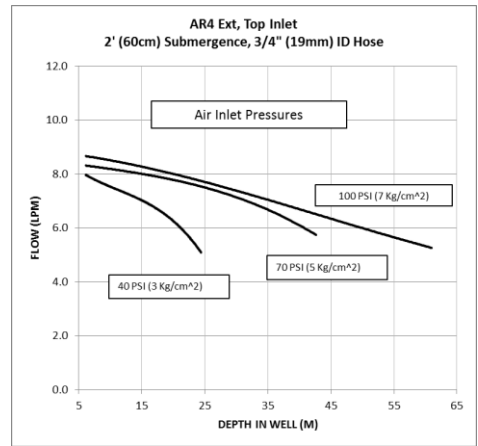
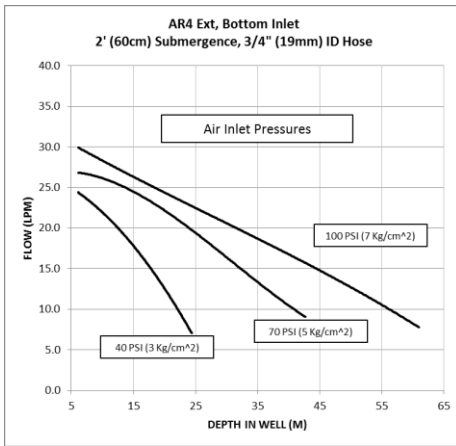
**Figure A-8:** AR4 Long Bottom/Top Inlet 10' (3 m) Submergence, 3/4" (19 mm) ID Hose in LPM

## Performance Curves AR4 EXT Series- Metric

Information below is for estimation purposes only. Performance will vary with site specifics. Flow is measured in Liters Per Minute (LPM)

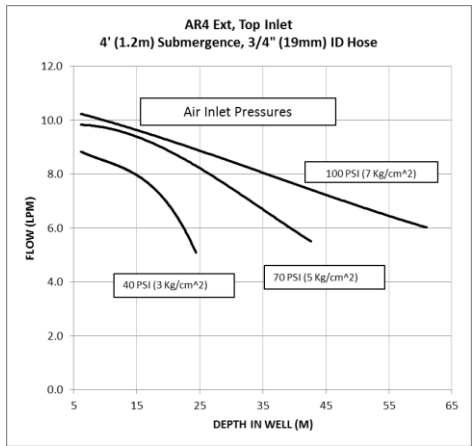
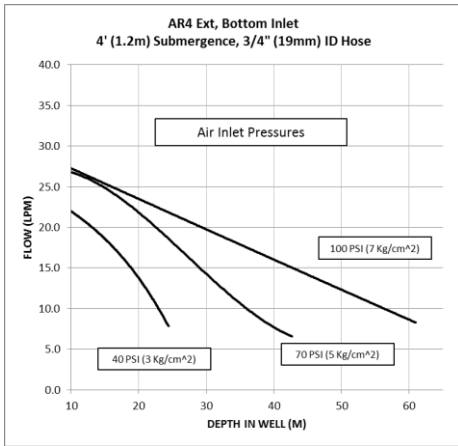


**Figure A-9:** AR4 EXT Bottom/Top Inlet 6" (15 cm) Submergence, 3/4" (19 mm) ID Hose in LPM

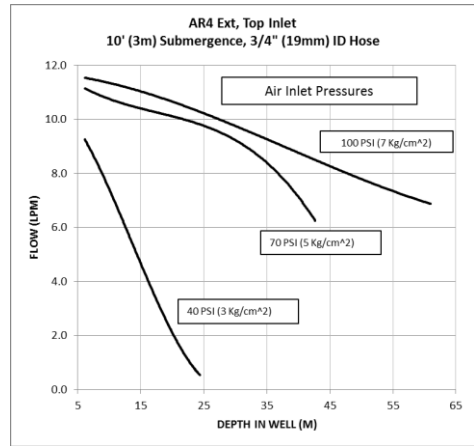
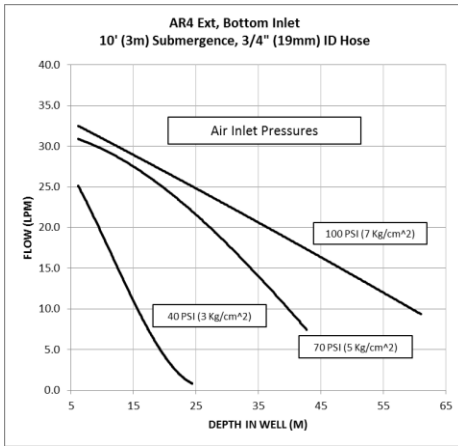


**Figure A-10:** AR4 EXT Bottom/Top Inlet 2' (60 cm) Submergence, 3/4" (19 mm) ID Hose in LPM

Performance Curves AR4 EXT Series- Metric (continued)



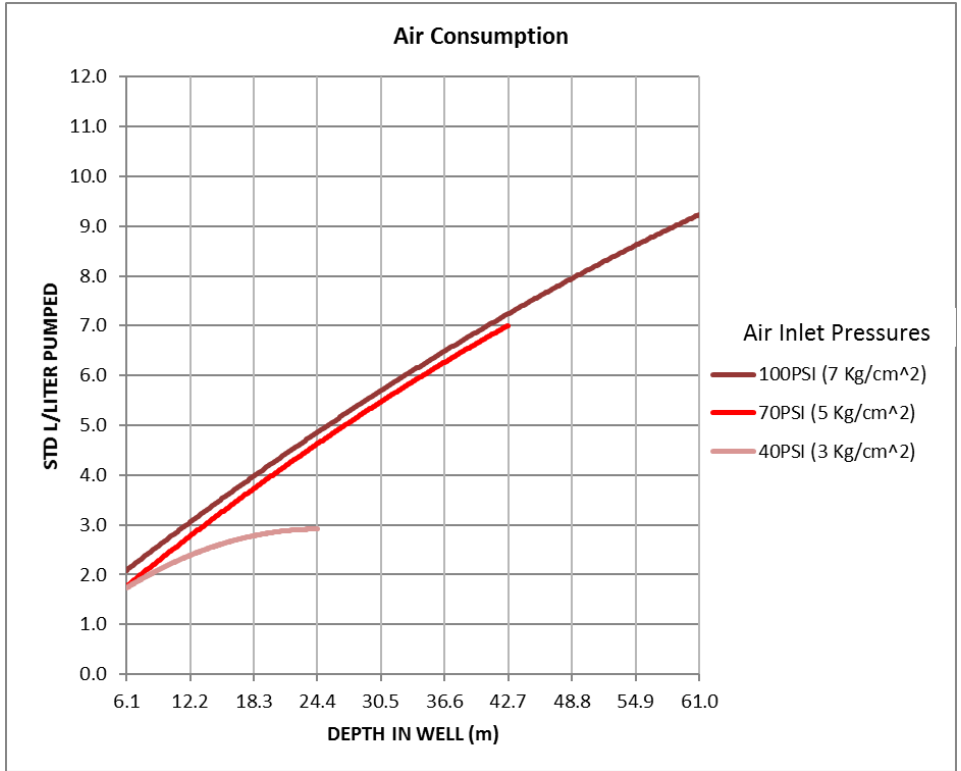
**Figure A-11: AR4 EXT Bottom/Top Inlet 4' (1.2 m) Submergence, 3/4" (19 mm) ID Hose in LPM**



**Figure A-12: AR4 EXT Bottom/Top Inlet 10' (3 m) Submergence, 3/4" (19 mm) ID Hose in LPM**

## Air Consumption- Metric

Depending on site conditions, Figure A-13 below estimates pump air consumption in Standard Liter of air per Liter pumped.



**Figure A-13:** Air Consumption in STD L/Liter Pumped

## Air Supply Pressure Drops – Metric

Considerations for airline pressure drops should be made when multiple pumps are located further from the airline regulator. Numbers were calculated as a total distance of airline away from regulator, for example, along ground plus distance from well cap to pump head, using plastic piping.

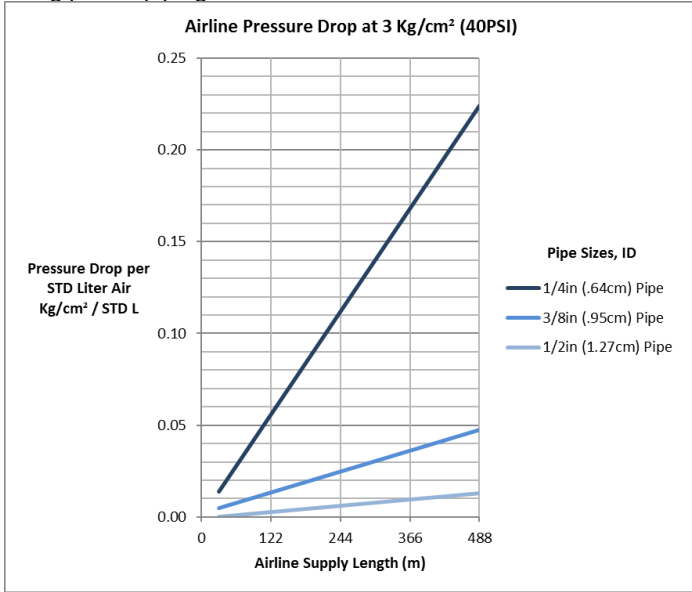


Figure A-14: Air Pressure Drop at 3 kg/cm²

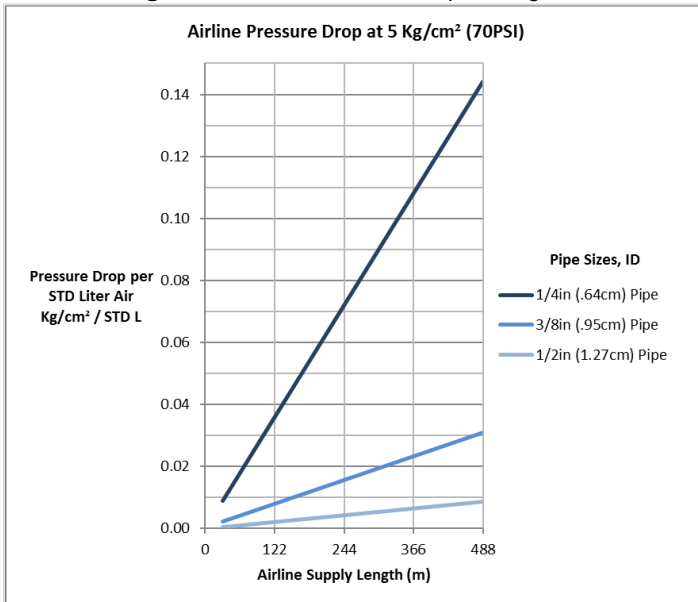
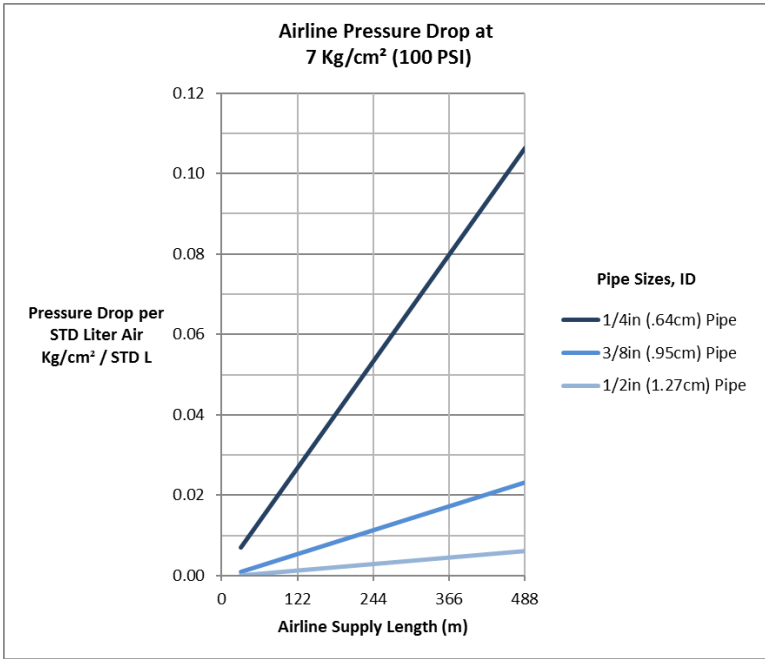


Figure A-15: Air Pressure Drop at 5 kg/cm²

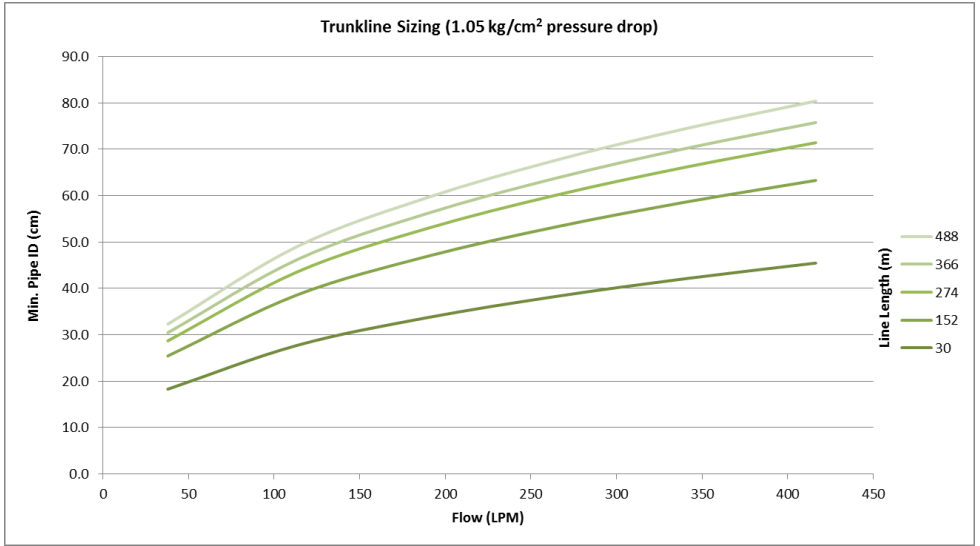


**Figure A-16: Air Pressure Drop at 7 kg/cm<sup>2</sup>**



## Discharge Trunkline Sizing – Metric

Information below is for reference only. Numbers provided were calculated for water flowing through plastic piping.



**Figure A-17: Trunkline Sizing 1.05 kg/cm<sup>2</sup> Pressure Drop**

<b>DOCUMENT REVISIONS</b>		
<b>EDCF#</b>	<b>DESCRIPTION</b>	<b>REV/DATE</b>
-	Initial Release	11/8/13
-	Added trunk line sizing tables, SP	11/26/13
Project 1382	Added performance spec. curves, DD	05/07/15
Project 1382	Updated manual to reflect pump improvements, DD	08/11/15
Project 1382	Updated pump flow curves, added Appendix A for metric flow curves, updated cover photo, TA/SB/SR	11/28/16
Project 1382	Updated formatting, specs and schematics, TA	2/7/17
Project 1545	Added Quick Connect and minor editds, StellaR/TA	10/9/2017
Project 1758	Removed OBS part numbers and updated with current part numbers, StellaR	5/13/2019
Project 2161	Updated figure 2-3, added low activation specs, StellaR	5/24/2021
Project 2233	Updated HDPE float with Syntactic Foam. Minor formatting changes.	8/23/2022

## The Warranty

For a period of one (1) year from date of first sale, product is warranted to be free from defects in materials and workmanship. Geotech agrees to repair or replace, at Geotech's option, the portion proving defective, or at our option to refund the purchase price thereof. Geotech will have no warranty obligation if the product is subjected to abnormal operating conditions, accident, abuse, misuse, unauthorized modification, alteration, repair, or replacement of wear parts. User assumes all other risk, if any, including the risk of injury, loss, or damage, direct or consequential, arising out of the use, misuse, or inability to use this product. User agrees to use, maintain and install product in accordance with recommendations and instructions. User is responsible for transportation charges connected to the repair or replacement of product under this warranty.

## Equipment Return Policy

A Return Material Authorization number (RMA #) is required prior to return of any equipment to our facilities, please call our 800 number for appropriate location. An RMA # will be issued upon receipt of your request to return equipment, which should include reasons for the return. Your return shipment to us must have this RMA # clearly marked on the outside of the package. Proof of date of purchase is required for processing of all warranty requests.

This policy applies to both equipment sales and repair orders.

FOR A RETURN MATERIAL AUTHORIZATION, PLEASE CALL OUR  
SERVICE DEPARTMENT AT 1-800-833-7958.

Model Number: \_\_\_\_\_

Serial Number: \_\_\_\_\_

Date of Purchase: \_\_\_\_\_

## Equipment Decontamination

Prior to return, all equipment must be thoroughly cleaned and decontaminated. Please make note on RMA form, the use of equipment, contaminants equipment was exposed to, and decontamination solutions/methods used. Geotech reserves the right to refuse any equipment not properly decontaminated. Geotech may also choose to decontaminate the equipment for a fee, which will be applied to the repair order invoice.

**Geotech Environmental Equipment, Inc.**

2650 East 40th Avenue Denver, Colorado 80205

(303) 320-4764 • **(800) 833-7958** • FAX (303) 322-7242

email: [sales@geotechenv.com](mailto:sales@geotechenv.com) website: [www.geotechenv.com](http://www.geotechenv.com)