

Geotech

3.5 Reclaimer

Installation and Operation Manual



Table of Contents

DOCUMENTATION CONVENTIONS.....	2
Section 1: System Description	3
Function and Theory	3
Section 2: System Installation	4
Section 3: System Operation	5
Top Fill	5
Bottom Fill	5
Section 4: System Maintenance	7
Section 5: System Troubleshooting.....	12
Section 6: System Specifications.....	13
Section 7: Replacement Parts List	15
The Warranty	21

DOCUMENTATION CONVENTIONS

This uses the following conventions to present information:



WARNING

An exclamation point icon indicates a **WARNING** of a situation or condition that could lead to personal injury or death. You should not proceed until you read and thoroughly understand the **WARNING** message.



CAUTION

A raised hand icon indicates **CAUTION** information that relates to a situation or condition that could lead to equipment malfunction or damage. You should not proceed until you read and thoroughly understand the **CAUTION** message.



NOTE

A note icon indicates **NOTE** information. Notes provide additional or supplementary information about an activity or concept.

Section 1: System Description

Function and Theory

The 3.5 Reclaimer is a positive air displacement pump designed for hydrocarbon recovery, leachate, condensate and total fluids applications. The pump is designed to withstand aggressive down-well environments, and highly corrosive fluids without material breakdown or failure.

The Geotech 3.5 Reclaimer can be configured as a Top fill, Bottom fill, or Top and Bottom fill fixed intake.

A PFAS-Free 3.5 Reclaimer model is also available. The PFAS-Free 3.5 Reclaimer is made with PFAS-Free materials such as 316 Stainless Steel, high-density polyethylene (HDPE) and Buna-Nitrile.



The Geotech 3.5 Reclaimer will recover fluids from depths up to 500' (152 m). Refer to *Section 3: System Operation*.

Flow rates of up to 4 GPM (15 LPM) are possible. Refer to *Section 6: System Specifications*.

The Geotech 3.5" Reclaimer will operate in wells 4" (10 cm) inside diameter or larger vertical wells.

Section 2: System Installation

Attach product discharge and air supply hoses to the proper barbed fittings on the pump. Refer to Figure 2-1 and 2-2 below for fitting configurations.



If pump configuration was not assembled as a complete system, please use the following steps:

1. Attach air supply hose to Geotech pneumatic controller air supply fitting.
2. Ensure all hoses are installed properly and securely to the fittings.
3. Attach the safety cable to the support loop using proper crimps or cable clamps.

The 3.5 Reclaimer can now be lowered into the recovery well. For optimum efficiency, the 3.5 Reclaimer must be positioned in the well with the intake adequately submerged.



Figure 2-1: 3.5 Reclaimer Bottom Fill

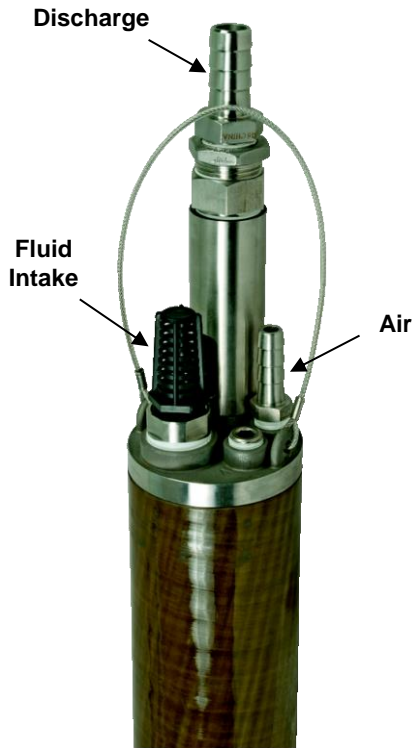

Figure 2-2: 3.5 Reclaimer Top Fill

Section 3: System Operation

Top Fill



Compressed air is utilized in this system. For pressure requirements, use 0.5 PSI per foot (.05 bar per 30.5 cm) of lift plus ten. For example, 30' (9 m) of head would need a minimum of 25 PSI (1.7 bar).



Volume of air consumption at ACFM is 1:1 to volume of discharged fluid. The conversion from GPM to CFM is approximately 7.5 GPM per CFM. For example, a fluid flow rate of 2 GPM would use approximately 2 GPM or 0.26 ACFM of air.

The volume is ACFM and will likely need to be converted to SCFM or other units based on your location and compressor settings.

The Top Fill Reclaimer is placed in a recovery well with the top inlet submerged below static groundwater. Combined with Geotech's BP 300 Controller the Reclaimer Cyclically fills and empties.

Bottom Fill



Well recharge rate and time sequence settings on the Geotech Pneumatic Controller will affect maintainable fluid level.

The Bottom Fill Reclaimer is placed in a recovery well with the bottom intake submerged below static groundwater. Combined with Geotech's BP 300 Controller, the Reclaimer cyclically fills and empties.



Well recharge rate and time sequence settings on the Geotech's BP 300 Controller will affect the maintainable fluid level. See Figure 3-2.

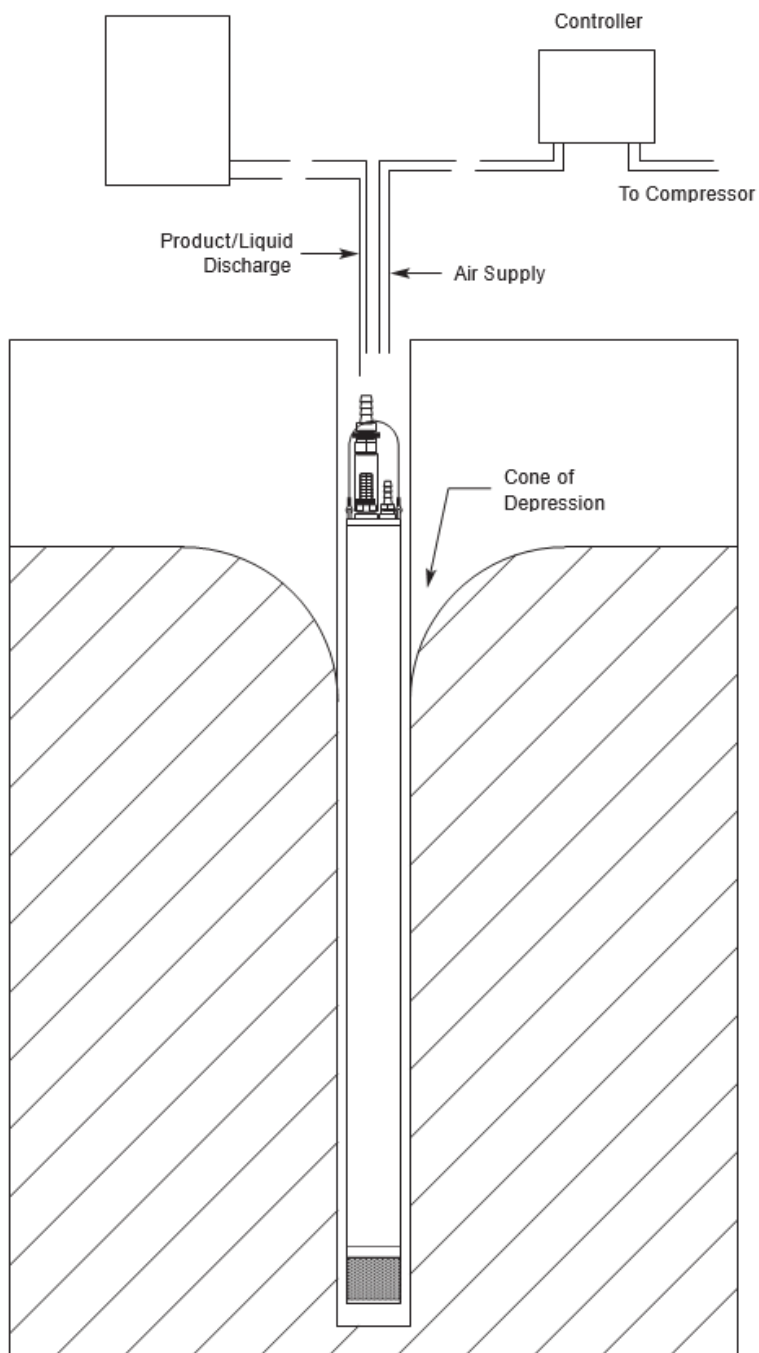

Figure 3-1: 3.5" Reclaimer

Section 4: System Maintenance

The Geotech Reclaimer has been designed to be virtually maintenance free. In the event clogging occurs in the pump or trapped particulate in the check ball seals, disassemble the Reclaimer pump and rinse with soapy or clean water to dislodge any matter. The Reclaimer is constructed of 300 series stainless steel and PTFE * to provide many years of continued service with minimal maintenance. See Figure 4-1.

*Except in the case of the PFAS-Free models.

See below for assemble and disassembly instructions:

- 1) Remove discharge using an adjustable wrench.

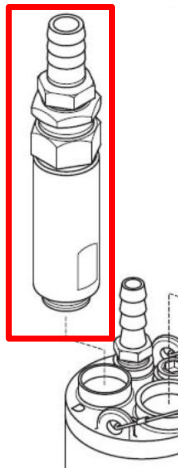

- 2) Remove bushing using an adjustable wrench and check for debris. Clean as necessary.

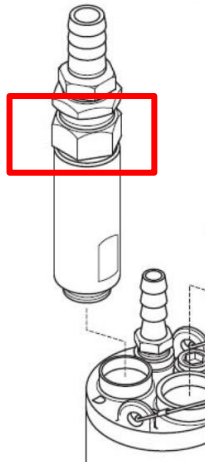

- 3) Check body discharge for debris. Clean as necessary.

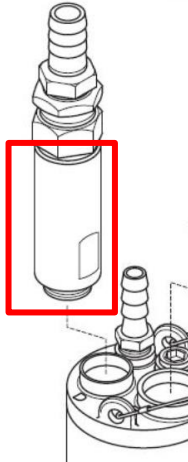

- 4) Check discharge hole for debris. Clean as necessary.
- 5) For the top fill Reclaimer, remove the screen intake assembly using a 1 3/16 wrench. Clean as necessary.

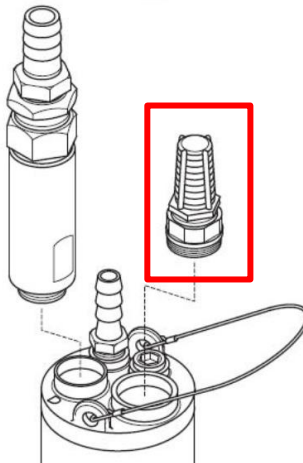

- 6) Remove screen intake from bushing. Clean as necessary.
- 7) Check intake hole and check ball. Clean as necessary.

For Top Fill Reclaimer

- 1) Using a 4" Spanner Wrench, remove the bottom head of the Reclaimer.

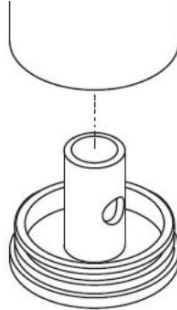

- 2) Check O-rings. Add grease if needed. Clean as necessary.
- 3) Check the check ball. Clean as necessary.

For Bottom Fill Reclaimer

- 1) If the reclaimer has a screen a flat screen or 3" screen, remove the screen using a 3/16 Alan Wrench.

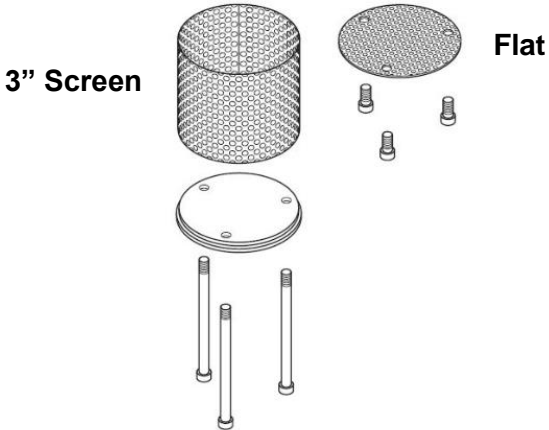

- 2) If the reclaimer has a 12" screen, use a 7/16 wrench to remove the hex nut.

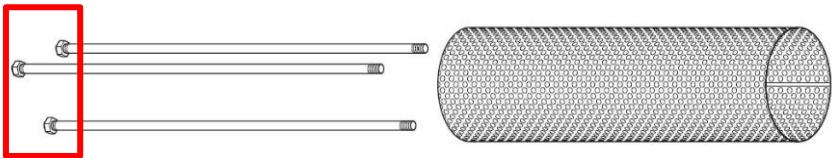

- 3) Using a 4" Spanner Wrench, remove the bottom head of the reclaimer.

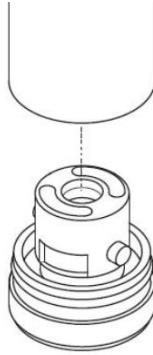

- 4) Remove the slide pin.

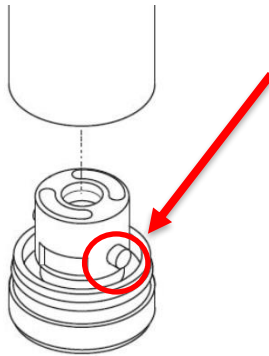

- 5) Check O-rings. Add grease if needed. Clean as necessary.
6) Check the check ball. Clean as necessary.

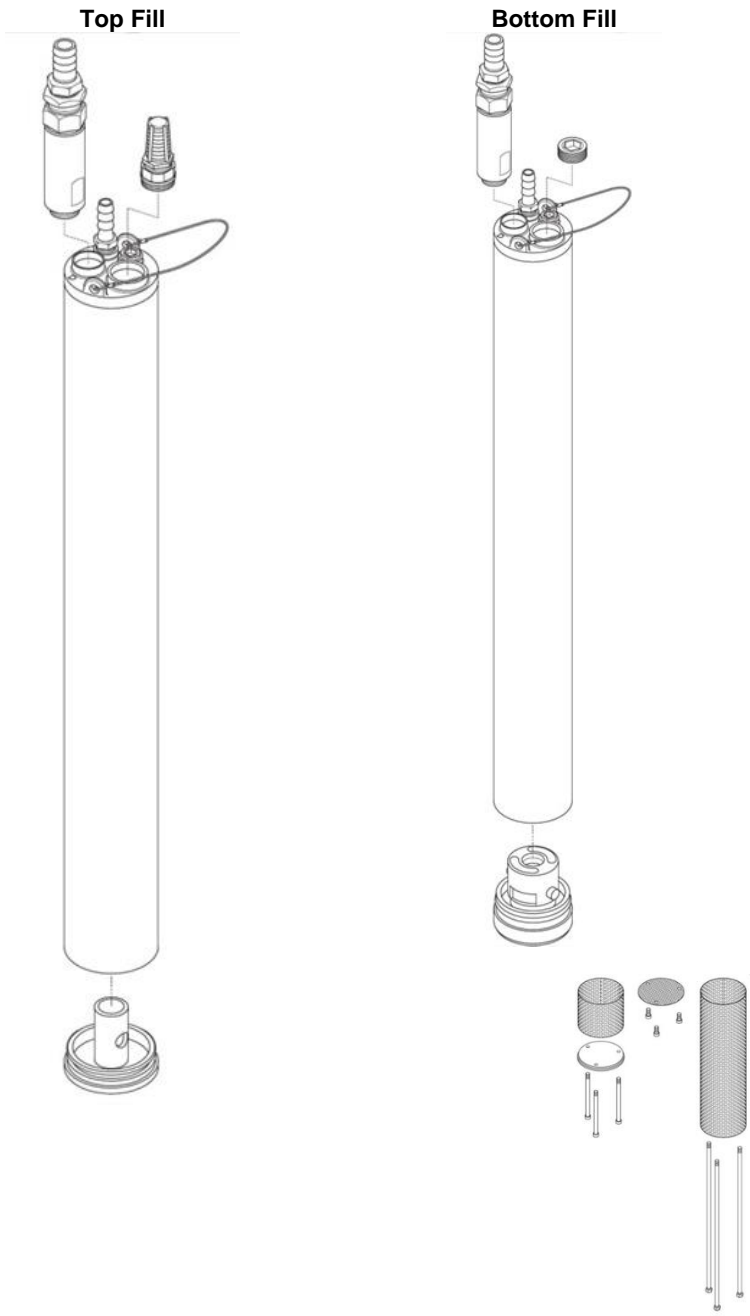

Figure 4-1: Top and Bottom Fill Reclaimer

Section 5: System Troubleshooting

Problem: Pump does not discharge fluid to the surface

Solutions:

1. Check controller to ensure it is functioning. Consult controller manual.
2. Ensure that the air pressure is adequate enough to overcome the total dynamic head pressure the pump is working against.
 - Consult the controller manual for air pressure requirements needed.
3. Inlet screen is clogged
 - Remove pump from well, disassemble, clean screen.
4. Discharge line is clogged
 - Remove pump from well, disassemble, clear, clean discharge line
5. Air line is clogged
 - Remove pump from well, disassemble, clear air line
6. Hoses are kinked or cut – Replace damaged hoses

Section 6: System Specifications

3.5 Reclaimer

Max Temp	212F (100C)
Outside Diameter	3.5" (8.9 cm)
Max Operating Depth	500' (152 m)
Min Well ID	4" (10 cm)
Max Flowrate	4 GPM (15 LPM)
Fittings	Stainless Steel
Fluid Discharge	3/4" NPT X 3/4" Hose barb
Air Supply	3/8" NPT X 1/2" Hose barb

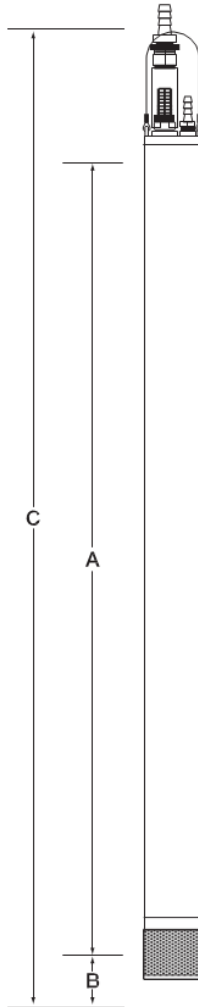

3.5 Reclaimer Configuration	Dimensions - inches (cm)			Weight lbs. (kg)	Volume /Cycle gallons (liters)	Max. Flow Rate GPM (LPM)
	A	B	C			
24" Top Fill	24 (61)	0	32 (81.3)	12.0 (5.4)	0.5 (1.9)	3 (11.4)
24" Bottom Fill (No Screen)	24 (61)	0	32 (81.3)	12.0 (5.4)	0.5 (1.9)	3 (11.4)
24" Bottom Fill (Flat Screen)	24 (61)	0.5 (1.3)	32.5 (82.5)	12.0 (5.4)	0.5 (1.9)	3 (11.4)
24" Bottom Fill (3" Screen)	24 (61)	3 (7.6)	35 (88.9)	12.3 (5.6)	0.5 (1.9)	3 (11.4)
24" Bottom Fill (12" Screen)	24 (61)	12 (30.5)	44 (111.8)	13.8 (6.3)	0.5 (1.9)	3 (11.4)
24" Top & Bottom Fill (No Screen)	24 (61)	0	32 (81.3)	12.0 (5.4)	0.5 (1.9)	3 (11.4)
24" Top & Bottom Fill (Flat Screen)	24 (61)	0.5 (1.3)	32.5 (82.5)	12.0 (5.4)	0.5 (1.9)	3 (11.4)
24" Top & Bottom Fill (3" Screen)	24 (61)	3 (7.6)	35 (88.9)	12.3 (5.6)	0.5 (1.9)	3 (11.4)
24" Top & Bottom Fill (12" Screen)	24 (61)	12 (30.5)	44 (111.8)	13.8 (6.3)	0.5 (1.9)	3 (11.4)
36" Top Fill	36 (91)	0	44 (111.8)	14.8 (6.7)	1 (3.8)	3.6 (13.6)
36" Bottom Fill (No Screen)	36 (91)	0	44 (111.8)	14.8 (6.7)	1 (3.8)	3.6 (13.6)
36" Bottom Fill (Flat Screen)	36 (91)	0.5 (1.3)	44.5 (113)	14.8 (6.7)	1 (3.8)	3.6 (13.6)
36" Bottom Fill (3" Screen)	36 (91)	3 (7.6)	47 (119.4)	15.0 (6.8)	1 (3.8)	3.6 (13.6)
36" Bottom Fill (12" Screen)	36 (91)	12 (30.5)	56 (142.2)	16.5 (7.5)	1 (3.8)	3.6 (13.6)
36" Top & Bottom Fill (No Screen)	36 (91)	0	44 (111.8)	14.8 (6.7)	1 (3.8)	3.6 (13.6)
36" Top & Bottom Fill (Flat Screen)	36 (91)	0.5 (1.3)	44.5 (113)	14.8 (6.7)	1 (3.8)	3.6 (13.6)
36" Top & Bottom Fill (3" Screen)	36 (91)	3 (7.6)	47 (119.4)	15.0 (6.8)	1 (3.8)	3.6 (13.6)
36" Top & Bottom Fill (12" Screen)	36 (91)	12 (30.5)	56 (142.2)	16.5 (7.5)	1 (3.8)	3.6 (13.6)
48" Top Fill	48 (122)	0	56 (142.2)	16.3 (7.4)	1.3 (4.9)	4 (15.1)
48" Bottom Fill (No Screen)	48 (122)	0	56 (142.2)	16.3 (7.4)	1.3 (4.9)	4 (15.1)
48" Bottom Fill (Flat Screen)	48 (122)	0.5 (1.3)	56.5 (143.5)	16.3 (7.4)	1.3 (4.9)	4 (15.1)
48" Bottom Fill (3" Screen)	48 (122)	3 (7.6)	59 (149.9)	16.5 (7.5)	1.3 (4.9)	4 (15.1)
48" Bottom Fill (12" Screen)	48 (122)	12 (30.5)	68 (172.7)	18.0 (8.2)	1.3 (4.9)	4 (15.1)
48" Top & Bottom Fill (No Screen)	48 (122)	0	56 (142.2)	16.3 (7.4)	1.3 (4.9)	4 (15.1)
48" Top & Bottom Fill (Flat Screen)	48 (122)	0.5 (1.3)	56.5 (143.5)	16.3 (7.4)	1.3 (4.9)	4 (15.1)
48" Top & Bottom Fill (3" Screen)	48 (122)	3 (7.6)	59 (149.9)	16.5 (7.5)	1.3 (4.9)	4 (15.1)
48" Top & Bottom Fill (12" Screen)	48 (122)	12 (30.5)	68 (172.7)	18.0 (8.2)	1.3 (4.9)	4 (15.1)

Section 7: Replacement Parts List

Item	Qty	Description	Part No.
1	1	HOSEBARB, SS6, 3/4 x 3/4 MPT	16600218
2	1	BUSHING, SS4, 1" x .75"	PPP012052
3	1	BUSHING, SS4, ORBITAL, DISCH 3.5	26600196
4	1	BALL, SS, 7/8"	17500207
5	1	BODY, SS4, DISCHARGE, 3.5 AUTO	26600169
6	1	HOSEBARB, SS6, 1/2 x 3/8 MPT	16600217
7	1	SCREEN, INTAKE, PVC, 3.5 AUTO	16600211
8	1	BUSHING, SS4, INTAKE, 3.5	26600152
9	1	BALL, PTFE, 7/8"	16600098
	1*	*BALL, HDPE, 7/8"	16600404
10	1	PLUG, SS4, 1" NPT, SCK HEX	16600156
11	1	HEAD, RECLAIMER, 3.5	26600212
12	2	O-RING, VITON, #336	17500516
	2*	*O-RING, #336, BUNA-N	16600403
13	1	PIPE, CENTER, SS4, 3/4 x 24, 3.5 RECLAIMER	26600211
	1	PIPE, CENTER, SS4, 3/4 x 36, 3.5 RECLAIMER	26600218
	1	PIPE, CENTER, SS4, 3/4 x 48, 3.5 RECLAIMER	26600219
14	1	HOUSING, 3.5 RECLAIMER, 24"	56600062
	1	HOUSING, 3.5 AR/RECLAIMER, 36"	56600032
	1	HOUSING, 3.5 AR/RECLAIMER, 48"	56600030
15	1	CAP, BOTTOMINLET, 3.5	26600040
16	1	BOTTOMINLET, SS, 3.5	26600039
17	1	PIN, DOWEL, SS6, 1/2 x 2.80"	16600102
18	1	BALL, TFE, 1.5"	17500315
	1*	*BALL, HDPE, 1.5"	16600405
19	1	CAP, BOTTOMBLANK, SS, 3.5	26600042
20	1	SCREEN, INLET, SS, 3.5, FLAT	26600131
21	3	SCREW, SS8, 1/4-20 x 3/8, SHCS	16600166
22	1	SCREEN, INLET, SS, 3.5 x 3"	26600049
23	1	CAP, BOTTOMINLET SCREEN, 3.5	26600032
24	3	SCREW, SS8, 1/4-20 x 3.5", SHCS	16600091
25	1	SCREEN, INLET, SS, 3.5 x 12"	26600146
26	3	ROD, SS8, THD, 1/4-20 x 12.813	26600147
27	3	NUT, HEX, SST, 1/4-20	PPF011002
		MANUAL, RECLAIMER 3.5	26600223

Accessories	
BP, CONTROLLER, 0-300 PSI 0-690FT, ACCESSORY KIT	81150042
TUBING, 1/4 X 3/8 PE – 3/8 X 1/2 PE SKIP BONDED, FT	87050523
THREAD TAPE,PFAS FREE,.5"x600'	21150153

*Bottom check ball and O-rings for PFAS-Free Reclaimer models. LDPE tape is used on MPT threads on hose barbs so that PTFE tape can be avoided.

Components

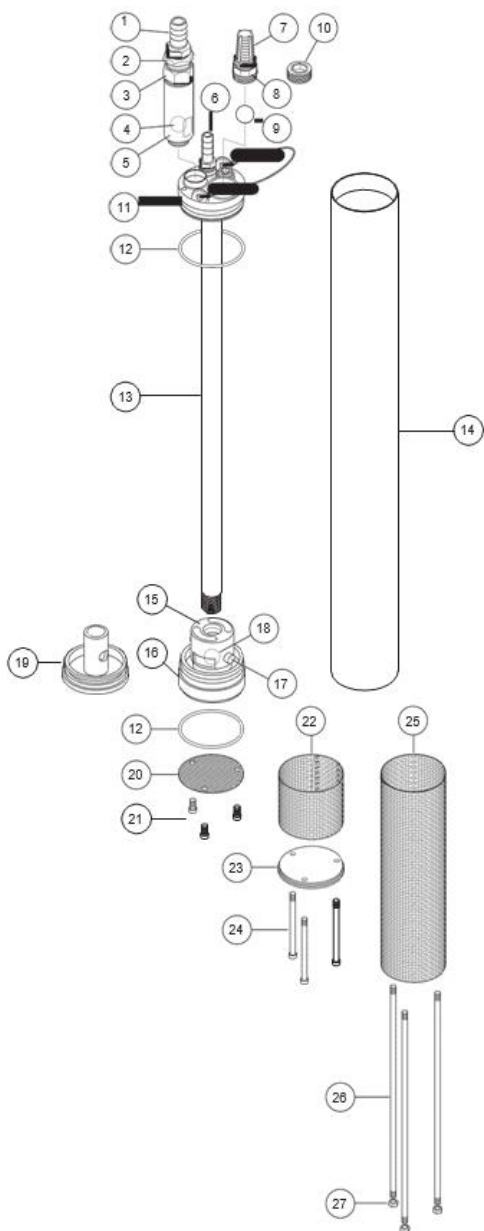

Revision History		
Project #	Description	Date
1675	Changed manual size to 5.5 X 8.5. Added PFAS-Free model – StellaR	7/13/2018
1758	Clarified figures, added air consumption + volume information, clarified fluid discharge, clarified air exhaust in trouble shooting, added accessories to parts list – StellaR	5/13/2019
1854	Added PN 21150153 – StellaR	10/18/2019

NOTES

NOTES

The Warranty

For a period of one (1) year from date of first sale, product is warranted to be free from defects in materials and workmanship. Geotech agrees to repair or replace, at Geotech's option, the portion proving defective, or at our option to refund the purchase price thereof. Geotech will have no warranty obligation if the product is subjected to abnormal operating conditions, accident, abuse, misuse, unauthorized modification, alteration, repair, or replacement of wear parts. User assumes all other risk, if any, including the risk of injury, loss, or damage, direct or consequential, arising out of the use, misuse, or inability to use this product. User agrees to use, maintain and install product in accordance with recommendations and instructions. User is responsible for transportation charges connected to the repair or replacement of product under this warranty.

Equipment Return Policy

A Return Material Authorization number (RMA #) is required prior to return of any equipment to our facilities, please call our 800 number for appropriate location. An RMA # will be issued upon receipt of your request to return equipment, which should include reasons for the return. Your return shipment to us must have this RMA # clearly marked on the outside of the package. Proof of date of purchase is required for processing of all warranty requests.

This policy applies to both equipment sales and repair orders.

FOR A RETURN MATERIAL AUTHORIZATION, PLEASE CALL OUR
SERVICE DEPARTMENT AT 1-800-833-7958.

Model Number: _____

Serial Number: _____

Date of Purchase: _____

Equipment Decontamination

Prior to return, all equipment must be thoroughly cleaned and decontaminated. Please make note on RMA form, the use of equipment, contaminants equipment was exposed to, and decontamination solutions/methods used. Geotech reserves the right to refuse any equipment not properly decontaminated. Geotech may also choose to decontaminate the equipment for a fee, which will be applied to the repair order invoice.

Geotech Environmental Equipment, Inc.
2650 East 40th Avenue Denver, Colorado 80205
(303) 320-4764 • **(800) 833-7958** • FAX (303) 322-7242
email: sales@geotechenv.com website: www.geotechenv.com