



GTRDD SERIES

HEATLESS DRYER INSTALLATION, OPERATION & MAINTENANCE MANUAL



TABLE OF CONTENTS

SECTION 1	General Information: Description of Operation	Pg 2
SECTION 2	Safety Instructions: Installation Safety Operation Safety	Pg 3
SECTION 3	Specifications: Air Flow Capacities Dimensions & Weights	Pg 3
SECTION 4	Installing the Dryer: Location Electrical Connections Piping and Connections Recommended Filters Recommended Dryer Installation Options Installation	Pg 4-7
SECTION 5	Start-Up Procedure	Pg 8
SECTION 6	Maintenance and Repair	Pg 8
SECTION 7	Troubleshooting Guide	Pg 9
SECTION 8	Replacement Parts	Pg 10-11
SECTION 9	Wiring Diagram	Pg 12
SECTION 10	Warranty / Claims	Pg 12

SECTION 1 GENERAL INFORMATION

1.1 DESCRIPTION OF OPERATION

The GTRDD Air Dryers use the pressure swing adsorption method of drying compressed air. This requires two identical towers containing beds of hygroscopic desiccant.

Incoming wet air enters the dryer through a shuttle valve where it is directed to the bottom of the tower containing dry desiccant. The desiccant in this tower removes 99.7+% of the water vapor from the air when operated at catalog conditions. The dried air leaving the top of the tower is directed to the outlet through a second shuttle valve. In this outlet shuttle valve a built-in orifice allows a portion of the dried air to flow into the other tower being regenerated. The orifice reduces the high-pressure air down close to atmospheric pressure which lowers the dew point of the dried air even further.

The tower being regenerated/purged of moisture is connected to an energized solenoid valve for a controlled period of time. The electrical signal to the solenoid is monitored by an LED light on the solid-state timer. After the desiccant is regenerated, the timer de-energizes the solenoid valve. Air continues to flow through the orifice to repressurize the regenerated tower to line pressure. The middle light on the timer indicates the repressurization function.

Next, the timer opens the valve on the tower containing the wet desiccant. This shifts the shuttle valves, and the tower with the wet desiccant is regenerated while the other tower continues to dry the air. Examining the flow schematic to the right demonstrates the dryer process operation.

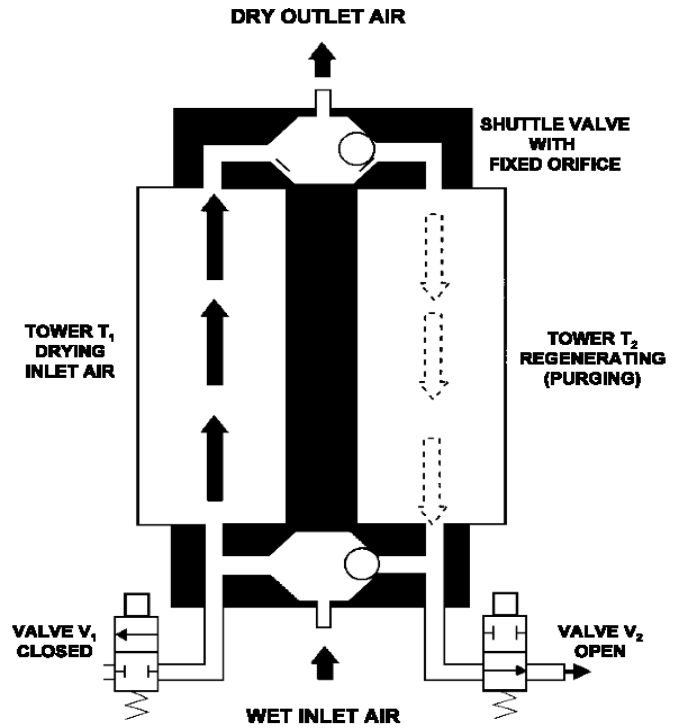

GTRDD 3-12 TIMING CYCLE	
•	V ₂ energized (open) 33 seconds
•	T ₂ repressurizing 12 seconds
•	V ₁ energized (open) 33 seconds
•	T ₁ repressurizing 12 seconds
Total cycle is 90 seconds with 45 seconds drying per tower.	

GTRDD 16-50 TIMING CYCLE	
•	V ₂ energized (open) 66 seconds
•	T ₂ repressurizing 24 seconds
•	V ₁ energized (open) 66 seconds
•	T ₁ repressurizing 24 seconds
Total cycle is 180 seconds with 90 seconds drying per tower.	

SECTION 2 SAFETY INSTRUCTIONS

2.1 INSTALLATION SAFETY

Before starting or installing the dryer, be sure that all power to the unit is off, valves are shut, and the air circuit is at atmospheric pressure. DO NOT remove, repair, or replace any component, control filter, or part, while the air circuit is energized or under pressure. Turn off the main to the dryer and de-pressurize the unit before starting installation or maintenance procedures.

MANUFACTURER WILL NOT BE RESPONSIBLE FOR DAMAGE TO EQUIPMENT AS A RESULT OF IMPROPER WIRING OR ELECTRICAL INSTALLATION. IT IS THE CUSTOMERS RESPONSIBILITY TO ENSURE THAT THE ELECTRICAL INSTALLATION IS CORRECT AND UP TO APPLICABLE CODES.

When installing the dryer, ensure that the NEMA rating of the control box is applicable to the installation.

Dryer is rated NEMA 4.

2.2 OPERATION SAFETY

DO NOT OPERATE THE DRYER ABOVE THE STATED WORKING PRESSURE (SEE SPECIFICATION TABLE). FAILURE, INJURY AND EQUIPMENT DAMAGE COULD RESULT.

CAUTION:

EXCEPT as otherwise specified by the manufacturer, this product is specifically designed for compressed air service and use with any other gas or liquid is a misapplication. Use with or injection of certain hazardous liquids or gases in the system (i.e., alcohol or liquid petroleum gas) could be harmful to the unit and result in a combustible condition or cause hazardous external leakage.

Manufacturer's warranties are void in the event of a misapplication and manufacturer assumes NO RESPONSIBILITY for any resulting loss.

Before using equipment with fluids or gases other than air, or for non-industrial applications, consult Geotech for written approval.

SECTION 3 SPECIFICATIONS

3.1 AIR FLOW CAPACITIES & DIMENSIONS & WEIGHTS

MODEL	3	6	9	12	16	25	35	50
Flows at 100 PSIG:	SCFM (m³/m)	SCFM (m³/m)	SCFM (m³/m)	SCFM (m³/m)	SCFM (m³/m)	SCFM (m³/m)	SCFM (m³/m)	SCFM (m³/m)
Inlet Flow	3.0 (.085)	6.0 (.1699)	9.0 (.2549)	12.0 (.3398)	16.0 (.4531)	25.0 (.708)	35.0 (.9912)	50.0 (1.416)
Purge Flow	0.8 (.0227)	1.6 (.0453)	2.4 (.068)	3.2 (.0906)	3.4 (.0963)	5.4 (.1529)	7.8 (.2209)	10.8 (.3059)
Outlet Flow	2.2 (.0623)	4.4 (.1246)	6.6 (.1869)	8.8 (.2492)	12.6 (.3568)	19.6 (.5551)	27.2 (.7703)	39.2 (1.110)
Connections (NPT):								
Inlet Port	3/8"	3/8"	3/8"	3/8"	1/2"	1/2"	1/2"	1/2"
Outlet Port	3/8"	3/8"	3/8"	3/8"	1/2"	1/2"	1/2"	1/2"
Dimensions:	In. (cm)	In. (cm)	In. (cm)	In. (cm)	In. (cm)	In. (cm)	In. (cm)	In. (cm)
H	13.6 (34.5)	18.2 (46.2)	17.3 (43.9)	20.1 (51)	33 (83.8)	41.9 (106.4)	39.3 (99.8)	46.3 (117.6)
W	7.4 (18.8)	7.4 (18.8)	7.4 (18.8)	7.4 (18.8)	9.5 (24.1)	9.5 (24.1)	10 (25.4)	10 (25.4)
D	5.2 (13.2)	5.2 (13.2)	5.2 (13.2)	5.2 (13.2)	6.5 (16.5)	6.5 (16.5)	7 (17.8)	7 (17.8)
P	9.3 (23.6)	13 (33)	12.1 (30.7)	14.9 (37.8)	20.7 (52.6)	29.5 (74.9)	26.5 (67.3)	33.5 (85.1)
A	5.8 (14.7)	5.8 (14.7)	5.8 (14.7)	5.8 (14.7)	7 (17.8)	7 (17.8)	9 (22.9)	9 (22.9)
B	2.8 (7.1)	2.8 (7.1)	2.8 (7.1)	2.8 (7.1)	23.6 (59.9)	31.3 (79.5)	31.3 (79.5)	37 (94)
Weight: Pounds (Kg)	8 (3.63)	9 (4.08)	10 (4.54)	11 (4.99)	29 (13.15)	34 (15.42)	59 (26.76)	65 (29.48)

Note: GTRDD 16-50 dryers (shown) have brackets top and bottom. GTRDD 3-12 dryers have single 4-hole brackets.

All Models:

Voltages Available	115/1/50/60, 230/1/50/60
Maximum Temperature	120°F (49°C) ambient
Maximum Pressure	150 PSIG (10 bar)
Outlet Dew Point	-40°F (-40°C) pressure dew point with 100°F (38°C) saturated inlet

Recommended Filtration On Inlet: 5.0 micron particulate filter and 0.01 micron coalescing filter w/auto drains

Note: Capacities shown are with standard orifice. Capacity is higher when pressure is higher than 100 PSIG. Capacity is lower when pressure is lower than 100 psig. Consult factory for non-standard pressures and dew points; an orifice change may be required.

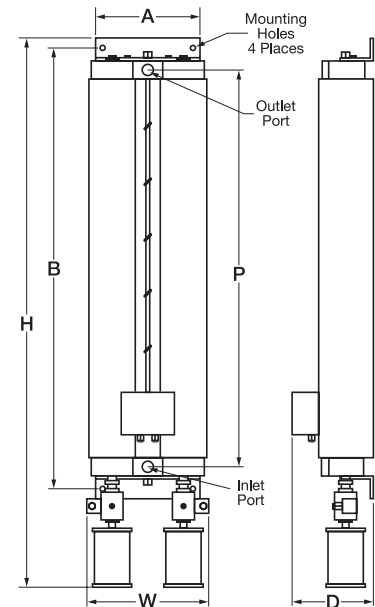

SECTION 4 INSTALLING THE DRYER

4.1 LOCATION

DO NOT INSTALL DRYER IN AN ENVIRONMENT OF CORROSIVE CHEMICALS, EXPLOSIVE GASES, OR AREAS OF HIGH AMBIENT TEMPERATURE CONDITIONS.

Install the dryer indoors. Dryers are not meant to be installed outdoors exposed to the weather. If the dryer must be installed outdoors, it must be in a weatherproof enclosure that provides for proper temperature control. Ambient operating temperatures should be between 33°F (.55°C) and 125°F (51.7°C).

When mounting, allow 2.5 inches above unit for tower removal and replacement.

The dryer may be installed in a vertical or horizontal (laying flat) orientation. Installation on its side may contribute to possible shuttle valve shifting problems.

4.2 ELECTRICAL CONNECTIONS

Before wiring, check the dryer nameplate for electrical characteristics. Standard electrical characteristics are 115 volt, 1 phase, 50/60 Hz. Models operating on 230 volts are available.

IMPORTANT! No overload protection is provided in the dryer and unit should be wired into a protected circuit.

IMPORTANT! When installing electrical service to this machine, comply with the National Electrical Code as well as state and local building codes.

NOTE: Dryer cycle timer has infinite memory capacity. Dryer may be wired to compressor pressure switch or auxiliary contacts to allow dryer to start and stop with compressor or machine tool. Contacts must supply same voltage and phase as dryer requires.

A six foot power cord is installed as standard on the dryer. The control box and bulkhead fittings are NEMA 4 rated.

- *If maintaining the NEMA 4 rating of the installation is desired, option A or B below may be used:*

A. Cut off the plug and use a NEMA 4 gasketed bulkhead fitting suitable for .180" diameter power cord to enter a NEMA 4 rated junction box.

- or -

B. To use flexible liquid-tight conduit and stranded 18 gauge wire:

1. Remove clear cover from control box.
2. Loosen nuts on (3) bulkhead connectors and push an inch or two of each of the electrical cords back into the control box to allow slack to pull out solid state timer board. Remove four screws holding solid state timer board and pull back gently to expose the "power in" terminal block. With small screwdriver, loosen wire clamps on terminal block and disconnect power cord wires.
3. Remove (1) backing nut from inlet power cord bulkhead fitting and remove power cord and bulkhead fitting.
4. Enlarge existing hole to proper size to install your own liquid-tight conduit fitting. Use only flexible liquid-tight conduit as installing rigid conduit may damage polycarbonate control box.
5. Connect to "power in" terminal block with 18 gauge stranded wire only.

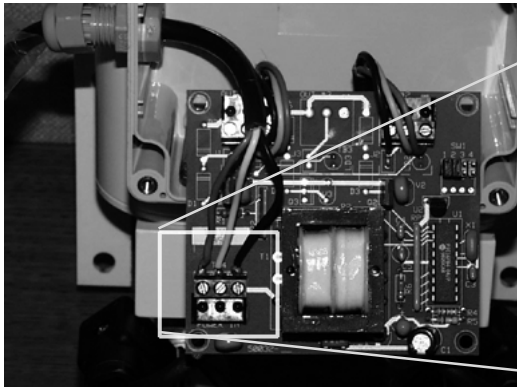

BACK SIDE OF
TIMER BOARD

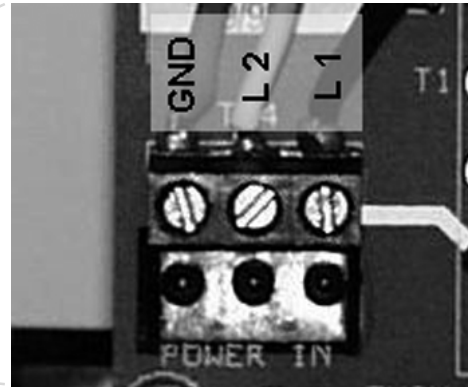

POWER IN
TERMINAL BLOCK

- *If a NEMA 1 installation is desired:*

A. You may simply plug the power cord into a standard outlet.

- or -

B. Use standard flexible conduit, and follow the instructions for installing liquid-tight conduit above. Use only flexible conduit as installing rigid conduit may damage polycarbonate control box. Connect to inlet power terminal strip with 18 gauge stranded wire only.

4.3 PIPING AND CONNECTIONS

Inlet and outlet piping should be schedule 40 pipe or equivalent I.D. tubing. See specification chart for inlet/outlet NPT thread size. All piping should be deburred and threaded to a proper depth and length before installation. Threads should be inspected for cleanliness and depth of cut. Good quality pipe compound or PTFE tape should be used in the makeup of joints to ensure a good, airtight fit of piping components.

NOTE ON INLET PIPING AND PIPE JOINTS: Make sure piping is clean inside. Apply pipe thread sealant sparingly to the male threads of fittings, keeping the sealant back from the first two threads. Contamination getting into inlet shuttle valve could cause dryer to malfunction.

Install a pipe union at the inlet and outlet ports for easy disconnection prior to tower replacement.

NOTE: If purge air is required to be piped to a remote location, it is necessary to use oversized tubing or piping to prevent back-pressure. Restricting the purge flow can cause the dryer to malfunction.

It is recommended that a bypass line with shut-off valves be installed to provide constant air flow to the system should the dryer require servicing.

4.4 REQUIRED FILTERS

Always install a 5 micron particulate prefilter with automatic drain and a 0.01 micron coalescing filter with automatic drain before dryer to remove entrained particulates, liquid moisture and oil which can cause damage to the desiccant beds. A particulate afterfilter should be installed after the dryer to remove any desiccant dust that may migrate from the desiccant beds. If a filter kit ("F"-Option) was ordered with dryer, the following filters were supplied:

4.5 RECOMMENDED DRYER INSTALLATION

TYPICAL POINT-OF-USE INSTALLATION

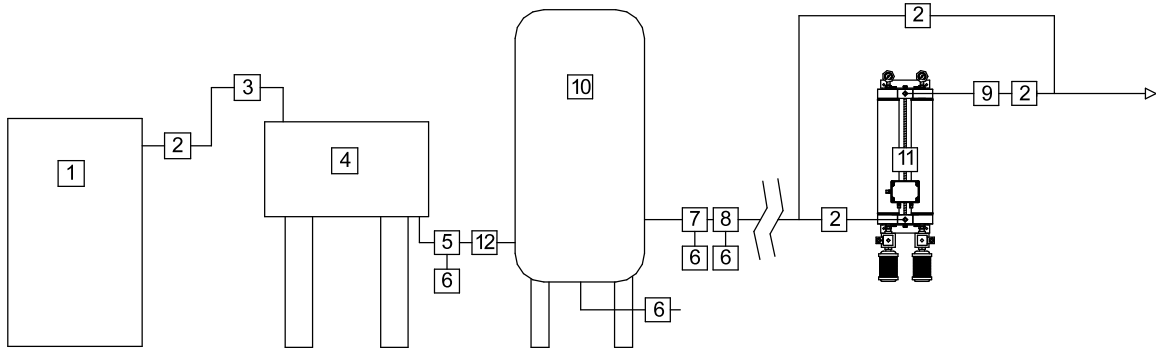

TYPICAL SYSTEM DRYER INSTALLATION

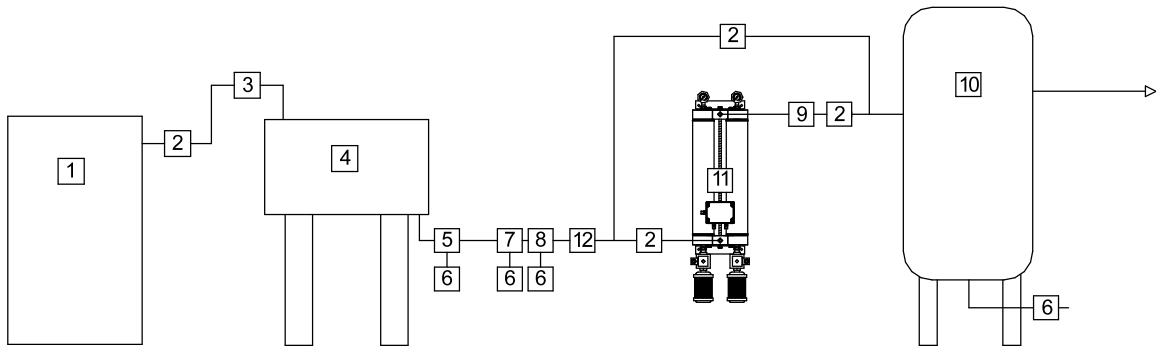

Ref. #	Description	Ref. #	Description
1	Compressor	7	Pre-Filter, 5 Micron Particulate, with Automatic Drain
2	Shut-off Valve	8	Pre-Filter, 0.01 Micron Coalescing, with Automatic Drain
3	Flex Connector	9	After-Filter, 0.5 Micron Particulate
4	Aftercooler	10	Storage Tank
5	Liquid Separator	11	GTRDD Series Desiccant Dryer
6	Drain Valve	12	Check Valve

4.6 OPTIONS INSTALLATION

The diagram below shows the installation positions for the "F" option filter kit, the "P" option tower pressure gauges kit, and the standard supplied purge mufflers. Other options come with separate instructions.

"F" OPTION FILTER KIT INSTALLATION:

Install prefilters on inlet air line as close to the dryer inlet port as possible. Pay close attention to the direction of flow arrow on the filter label.

NOTE ON INLET PIPING AND PIPE JOINTS: Make sure piping is clean inside. Apply pipe thread sealant sparingly to the male threads of fittings, keeping the sealant back from the first two threads. Contamination getting into inlet shuttle valve could cause dryer to malfunction. Use good quality pipe compound or PTFE tape in the makeup of joints to ensure a good, leak tight fit.

Prefilter #1 (5 micron) should be installed before prefilter #2 (0.01 micron coalescer) then followed by the dryer inlet. All filters must be installed in a vertical orientation (horizontal piping run) for proper operation and draining. Provisions must be made for handling of liquid condensates (water and compressor lubricant) emitted by the prefilters' automatic float drains.

Install afterfilter (0.5 micron) on outlet air line near dryer outlet port.

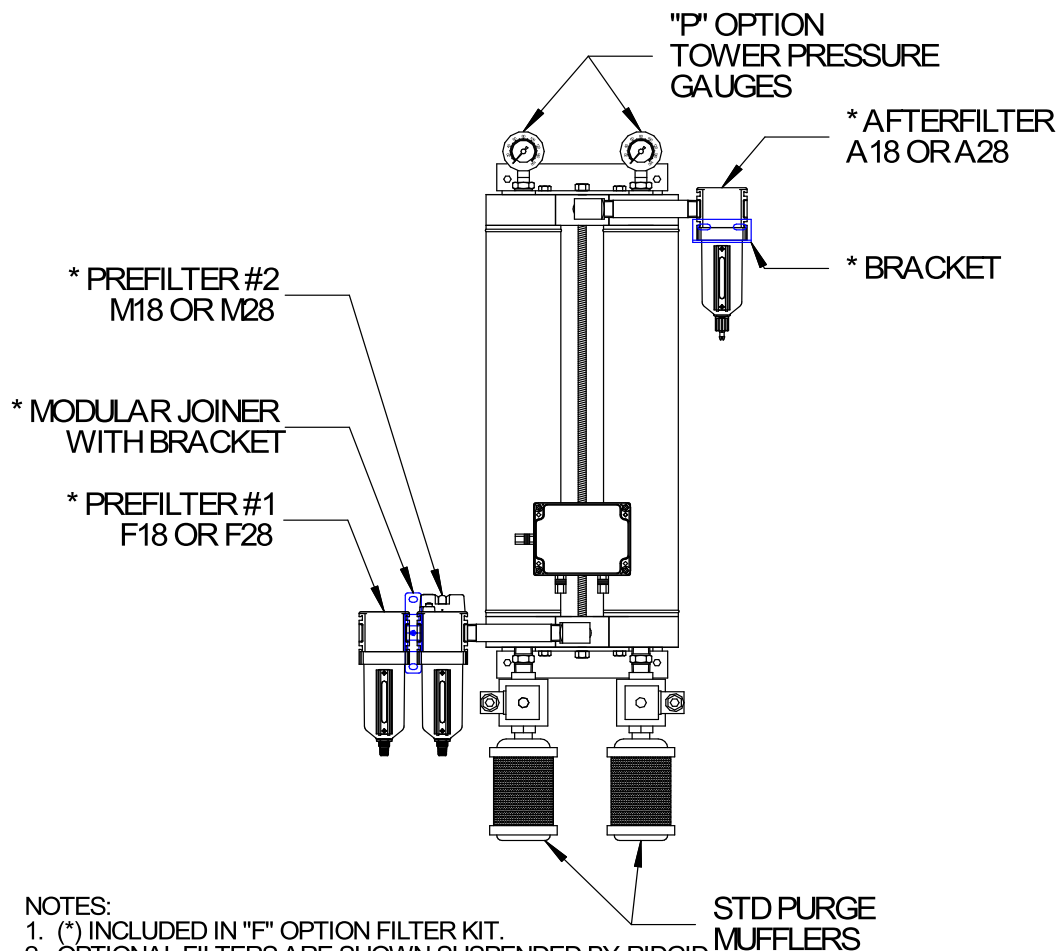

NOTES:

1. (*) INCLUDED IN "F" OPTION FILTER KIT.
2. OPTIONAL FILTERS ARE SHOWN SUSPENDED BY RIGID PIPING (NOT SUPPLIED).
3. OPTIONAL PREFILTERS AND AFTERFILTER MAY BE WALL MOUNTED USING BRACKETS SUPPLIED IN OPTIONAL FILTER KIT.
4. REMOVE GAUGE PORT PLUGS BEFORE INSTALLING "P" OPTION TOWER PRESSURE GAUGE KIT.

SECTION 5 START UP PROCEDURE

BEFORE STARTING THIS DRYER, FOLLOW THE INSTALLATION INSTRUCTIONS AND PROCEDURES COMPLETELY.

DO NOT REMOVE, REPAIR OR REPLACE ANY ITEM ON THE DRYER WHILE THE DRYER IS UNDER PRESSURE.

INITIAL START UPS

1. Confirm that all piping and electrical connections are proper.
2. Shut off electrical power.
3. If a bypass is installed around the dryer, open the inlet and outlet isolation valves. Close the bypass valve.
WARNING - When operating this dryer without the mufflers, use hearing protection.
4. Wait approx. 20 seconds to equalize pressure in the desiccant chambers.
5. Turn on the electrical power. Dryer should start cycling.
6. Verify purge cycle timing as described in Dryer Operation section.

SECTION 6 MAINTENANCE AND REPAIR

WARNING - DO NOT REMOVE, REPAIR, OR REPLACE ANY ITEM ON THE DRYER WHILE THE DRYER IS UNDER PRESSURE.

BEFORE BEGINNING ANY REPAIRS, MAINTENANCE, OR INSTALLATION WORK, VERIFY THAT THE POWER IS OFF AND THE DRYER IS DEPRESSURIZED.

BEFORE WORKING ON THE DRYER OR RELATED EQUIPMENT, ENSURE THAT ALL PERSONNEL HAVE READ AND UNDERSTAND THE SAFETY AND OPERATION INSTRUCTIONS IN THIS MANUAL.

PREVENTIVE MAINTENANCE SCHEDULE

This is a suggested schedule based on average dryer conditions. As conditions such as dirty environment, humidity conditions, ambient temperature, etc. change, the frequency of the inspections may change.

Daily

1. Inspect the dryer for proper operation.
2. Inspect inlet filters and drains for proper operation. It is time to change the inlet coalescing filter element if, during operation, the differential pressure indicator on top shows a red color instead of a green color.
3. Verify proper inlet and ambient air conditions.

Semi-Annually

1. Inspect entire assembly for loose connections, screws, etc.
2. Perform audible inspection of purge cycling and purge flow.
3. Visual inspection of exhaust area for signs of oil or desiccant attrition.

Annually

1. Replace prefilter and afterfilter elements. Refer to individual instructions supplied with the filter kit.

Every 2 to 5 Years

1. Replace desiccant chambers, if necessary.

SECTION 7 TROUBLESHOOTING GUIDE

A PROBLEM: AIR DRYER DELIVERS WET AIR			
	POSSIBLE CAUSE	CHECK	CORRECTIVE ACTION
A1	No power to unit.	Power supply.	Correct power problem.
A2	High inlet air temperature.	For standard units, inlet air temperature should not exceed 100°F. For specially sized units, inlet air temperature should not exceed sizing criteria stated at purchase.	Reduce inlet air temperature to proper level. An aftercooler may need to be installed after compressor.
A3	Air flow through dryer in excess of rated capacity.	Make sure inlet flow to dryer (compressor output, or if installed at point-of-use, total of air usage downstream of dryer plus purge flow) does not exceed inlet flow rating of dryer.	Reduce air usage downstream.
A4	Low inlet pressure.	For standard units, inlet air pressure should be 100 psig. For specially sized units, inlet air pressure should be same as sizing criteria stated at purchase.	Increase inlet pressure or call factory to resize dryer for actual inlet conditions.
A5	Dirty or obstructed inlet air filter.	Check inlet airline filter elements.	Replace.
A6	Purge orifice plugged.	Remove and inspect purge orifice.	Clean orifice hole of debris. Use air gun to clean.
A7	Solenoid coil burned out.	Check magnetic field from coil operation. Place iron or steel material (a screwdriver works well) at top of coil to feel the magnetic effect when coil should be energized. (Note: see Section 1, for timing cycle for your unit.)	Replace.
A8	Oil contamination of desiccant beds.	Verify particle/coalescing inlet filtration is adequate and functioning properly.	Towers must be replaced if contamination is suspected.
A9	Timer not operating properly.	Verify correct timing cycle by observing tower indicator lights on front panel. (Note: see Section 1, for timing cycle for your unit.)	Replace timer if defective.
A10	Purge flow restricted.	Check mufflers (or purge piping if installed) for excessive back-pressure. Note: unit is originally supplied with "no-clog" mufflers.	If purge air is piped away from unit, oversized piping should be used and length of run should be as short as possible.
B PROBLEM: RESTRICTED FLOW THROUGH UNIT			
	POSSIBLE CAUSE	CHECK	CORRECTIVE ACTION
B1	Improper operating conditions.	See A2, A3, A4 above.	
B2	Dirty or obstructed inlet air filter.	See A5 above.	
B3	Plugged air passages.	Check inlet and outlet air passages and piping for blockages.	Clear restrictions.
C PROBLEM: EXCESSIVE PURGE / BLOWDOWN			
	POSSIBLE CAUSE	CHECK	CORRECTIVE ACTION
C1	Inlet or outlet shuttle not shifting.	See A3, A4, A5, A6 above.	
C2	Inlet or outlet shuttle not shifting.	Check for damage or contamination of inlet and outlet shuttles.	Clean or replace as necessary.
C3	Purge orifice plugged.	See A6 above.	
C4	Timer not operating properly.	See A9 above.	
C5	Timer not operating properly.	Incoming power may not be "clean". Fluctuations in voltage can occur in power circuits shared by devices such as electric motors and welding equipment.	Supply line voltage from another source.
C6	Dirty or obstructed inlet air filter.	See A5 above.	
C7	Leakage.	With dryer pressurized, remove power from dryer. Check purge ports on dryer and air system connections for large leaks.	Repair as necessary.
C8	Purge flow restricted.	See A10 above.	

SECTION 8 REPLACEMENT PARTS

GTRDD Dryer Exploded View

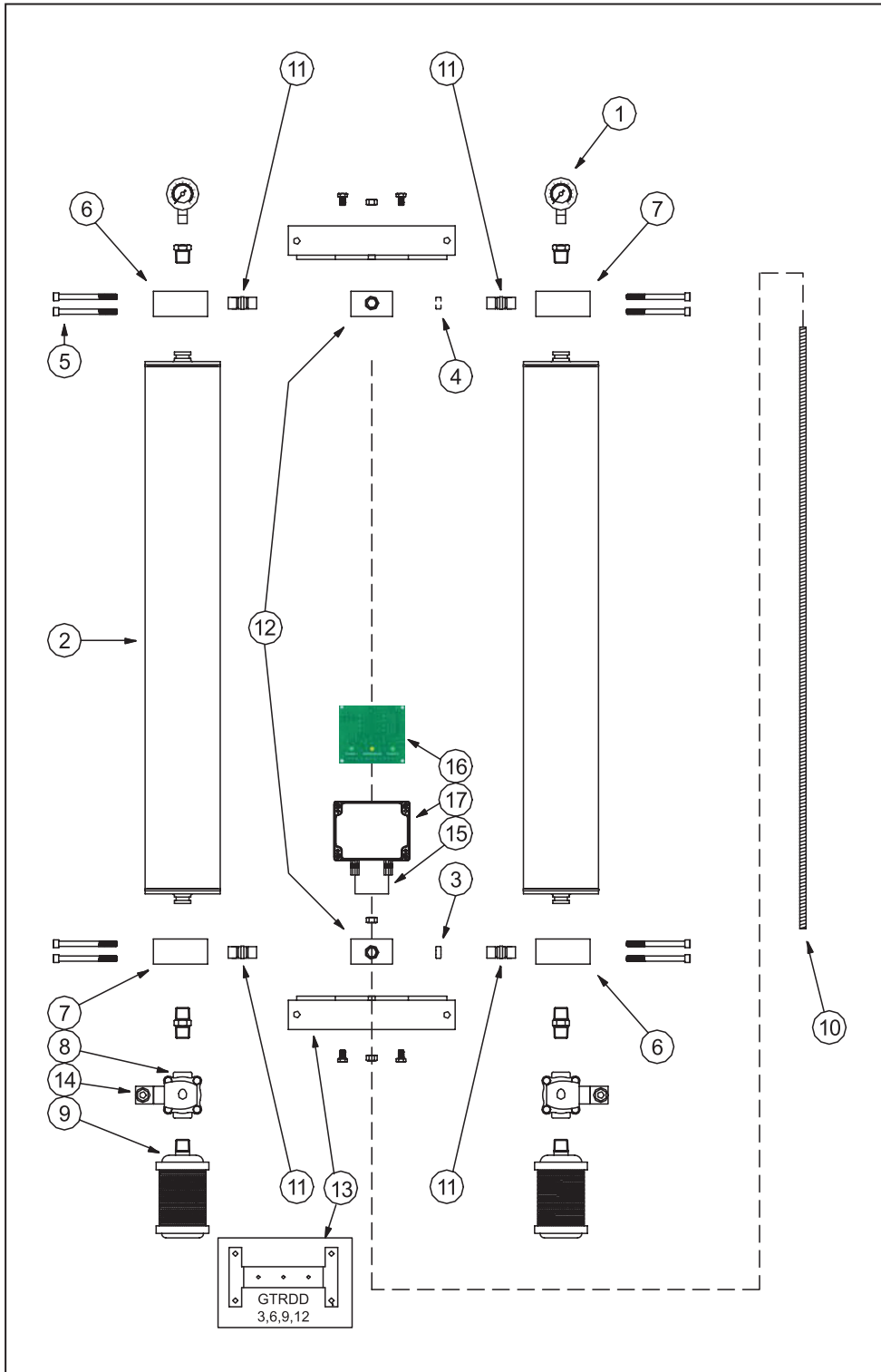

See chart on next page for part information.

See Exploded View on previous page for reference numbers.

REPLACEMENT PARTS		KIT CONTAINS QTY	FOR GTRDD MODEL							
REF #	DESCRIPTION		3	6	9	12	16	25	35	50
1	Tower Gauges (Optional)	2	20500	20500	20500	20500	30800	30800	30800	30800
2	Desiccant Tower	1	20100	20200	20300	20400	30500	30600	30650	30700
3	Shuttle Disc, Inlet	1	50080	50080	50080	50080	51014	51014	51014	51014
4	Shuttle Disc, Out w/Orifice, Standard	1	50085-30	50085-46	50085-57	50085-62	3064	3076	3090	3104
4a	Shuttle Disc, Out w/Orifice, Special	1	*50085-XX	*50085-XX	*50085-XX	*50085-XX	*3XXX	*3XXX	*3XXX	*3XXX
5	Screw	1	20006	20006	20006	20006	30006	30006	30006	30006
6	End Block, Top-L or Bottom-RT	1	20004	20004	20004	20004	30004	30004	30004	30004
7	End Block, Top-RT or Bottom-L	1	20005	20005	20005	20005	30005	30005	30005	30005
8	Solenoid Valve Assy 115 Volt	1	20009	20009	20009	20009	30009	30009	30009	30009
8a	Solenoid Valve Assy 230 Volt	1	20010	20010	20010	20010	30010	30010	30010	30010
9	Purge Muffler Kit	2	20502	20502	20502	20502	30802	30802	30802	30802
10	Tie Rod	1	CF	CF	CF	CF	CF	CF	CF	CF
11	Inlet/Outlet Shuttle Valve Seat	1	20002	20002	20002	20002	30002	30002	30002	30002
12	Shuttle Valve Body	1	20000	20000	20000	20000	30000	30000	30000	30000
13	Dryer Mounting Bracket	1	20015	20015	20015	20015	30015	30015	30015	50049
14	Solenoid DIN Connector	1	20011	20011	20011	20011	30011	30011	30011	30011
15	Control Box Bracket	1	20505	20505	20505	20505	30508	30508	30508	30508
16	Timer, SS, 115 VAC	1	20507-115V	20507-115V	20507-115V	20507-115V	50090-115V	50090-115V	50090-115V	50090-115V
16a	Timer, SS, 230 VAC	1	20507-230V	20507-230V	20507-230V	20507-230V	50090-230V	50090-230V	50090-230V	50090-230V
17	Control Box Enclosure	1	50075	50075	50075	50075	50075	50075	50075	50075
not shown	Viton O-ring Kit	**	50051	50051	50051	50051	30804	30804	30804	30804
not shown	Gauge Port Plug	1	20024	20024	20024	20024	30024	30024	30024	30024
Note: *Must specify orifice number from sticker on dryer control box or call factory with complete model number. Note: **Viton O-ring Kit includes all o-ring seals. Note: CF – Call Factory										

SECTION 9 WIRING DIAGRAM

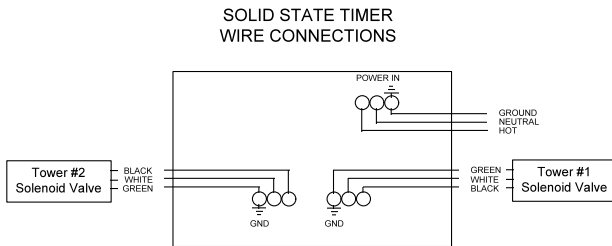

SECTION 10 WARRANTY AND WARRANTY CLAIM INFORMATION

Geotech GTRDD Series air dryers are warranted to be free of defects in materials and workmanship under proper use, installation and application. This limited warranty shall cover parts only, not including contaminated desiccant chambers and solenoid wearing parts for a period of 18 months from date of shipment or 12 months from date of installation, whichever comes first.

ALL FREIGHT DAMAGE CLAIMS ARE NOT THE RESPONSIBILITY OF THE MANUFACTURER AND ARE NOT COVERED UNDER WARRANTY AS ALL PRODUCTS ARE

SHIPPED F.O.B. SHIPPER. PLEASE DIRECT ALL FREIGHT CLAIMS TO THE FREIGHT CARRIER IN QUESTION.

This warranty does not apply to any unit damaged by accident, modification, misuse, negligence, or misapplication.

Any covered GTRDD air dryer part or material found defective will be repaired, replaced or refunded, at Geotech's option, free of charge, provided that Geotech is notified within the above stated warranty period. All returns of defective parts/equipment must have prior written Returned Material Authorization (RMA). RMA may be obtained from our dryer service department. All defective parts/equipment must be returned freight prepaid to the Geotech factory within 30 days of RMA issue date. Any shipment returned to the factory collect will be refused.

If an item is found to be warrantable, the repaired item or replacement will be shipped via standard ground freight prepaid within the continental US and Canada.

Any replacement part or material is warranted only to the extent of the remaining warranty period of the dryer or to the extent as provided by the supplier, whichever is longer.

ALL FREIGHT DAMAGE CLAIMS SHOULD BE FILED WITHIN 15 WORKING DAYS AND SHOULD BE DIRECTED TO THE FREIGHT CARRIER.