

PRELIMINARY
SUBJECT TO CHANGE

RAD8

Radon + Thoron Monitor

USER MANUAL

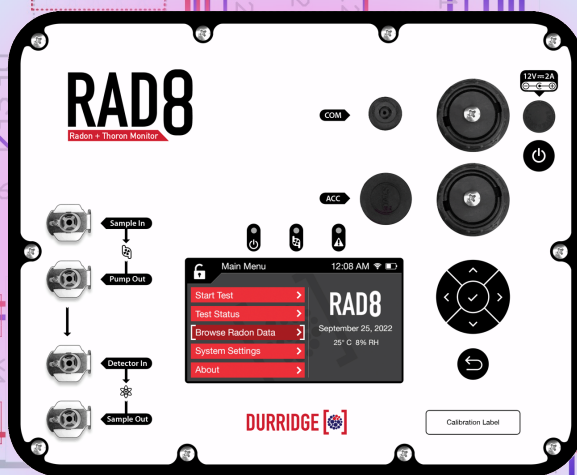

CALL GEOTECH TODAY
(800) 833-7958

Geotech Environmental Equipment, Inc.
2650 East 40th Avenue • Denver, Colorado 80205
(303) 320-4764 • FAX (303) 322-7242
email: sales@geotechenv.com • website: www.geotechenv.com

DURRIDGE 
Radon Capture & Analytics

Safety Warning



Opening the cover of this instrument is likely to expose dangerous voltages. Disconnect the instrument from all voltage sources while it is being opened. Due to battery power, the instrument may still be dangerous.

Using this instrument in a manner not specified by the manufacturer may impair the protection provided by the instrument.

Service Records

It is recommended that the RAD8 be returned to Durrige Company annually for recalibration.

Date: Service:

Owner: _____ Serial #: _____

Shipping and Contact Information

Durrige U.S. Office

900 Technology Park Drive
Billerica, MA 01821 USA
Phone: (978)-667-9556
Fax: (978)-667-9557

Durrige UK Office

Sheffield Technology Park
Cooper Buildings, Arundel Street
Sheffield S1 2NS, UK
Phone: +44 (0)114 221 2003

Email

service@durrige.com

Web

<http://durrige.com>

TABLE OF CONTENTS

Safety Warning	2
Service Records	2
Shipping and Contact Information	2
INTRODUCTION	8
1 GETTING STARTED: YOUR FIRST DAY WITH THE RAD8	9
1.1 Unpacking	9
1.2 General Safety Instructions	10
1.2.1 Air Travel	11
1.3 Taking a Look	11
1.4 Starting a Two-Day Test	12
1.4.1 Connecting the RAD8 Hardware	12
1.4.2 Setting Up the RAD8	13
1.4.3 Purging the RAD8	14
1.4.4 Starting the 2-Day Test	14
1.4.5 Completing the Test	15
1.5 Starting a Sniff Test	16
2 BASICS OF RAD8 OPERATION	18
2.1 Input Controls	18
2.2 Main Menu Organization	19
2.3 Starting a Radon Test	20
2.3.1 Overview	20
2.3.2 Setting the testing protocol	20
2.3.3 Configuring individual test parameters	20
2.3.4 Test Parameters	22
2.3.5 Analysis Modes	22
2.3.6 Pump Modes	23
2.3.7 Stopping a test	23
2.3.8 Purging the RAD8	24
2.4 Monitoring the Test Status	25
2.5 Browsing Stored Radon Data	27
2.5.1 Viewing Stored Data	27
2.6 Configuring System Settings	28
2.6.1 Measurement Unit Settings	28
2.6.2 Clock Settings	29
2.6.3 Audio Settings	30
2.6.4 Printing Settings	30
2.6.5 Display Settings	33
2.6.6 Locking and unlocking the RAD8	33
2.6.7 Graph View Settings	34

2.6.8 Spectrum View Settings	34
2.6.9 Managing Custom Test Protocols	34
2.6.10 Managing Storage Space	34
2.6.11 Wi-Fi Settings	34
2.6.12 Capture Cloud Settings	34
2.6.13 Firmware Update Settings	35
2.7 Viewing RAD8 Device Information	35
3 COMPUTER CONNECTIVITY	36
3.1 Computer Connection Basics	36
3.1.1 Connecting the RAD8 to a Computer via USB	36
3.2 Capture Software	37
3.2.1 Introduction to Capture	37
3.2.2 Capture Installation	37
3.2.3 Feature Summary	38
3.2.4 Downloading RAD8 Data	38
3.2.5 Graphing and Analysis	38
3.2.6 Real-Time RAD8 Monitoring	38
3.2.7 Capture Cloud	39
4 BASICS OF RAD8 TECHNOLOGY: HOW IT WORKS	40
4.1 Radon and Thoron Decay Chains	40
4.1.1 Radon-222 (Radon)	42
4.1.2 Radon-220 (Thoron)	42
4.2 Continuous Monitors	43
4.3 Radon Sniffers	44
4.4 Working Level	44
4.5 RAD8 Solid-State Detector	45
4.5.1 RAD8 Calibration and Data Correction	45
4.6 RAD8 Spectrum	46
4.7 Windows	47
4.8 Isotope Equilibrium	47
4.9 Analysis Modes: Rapid, Precise, and Automatic	49
4.10 Background	50
4.10.1 Short-lived Radon and Thoron Progeny	50
4.10.2 Adsorbed Radon Gas	50
4.10.3 Intrinsic Background	51
4.10.4 Long-lived Radon Daughters	51
4.10.5 Contamination by Radon, or Thoron, Producing Solids	51
4.10.6 Other Alpha Emitters	51
4.10.7 Beta and Gamma Emitters	51
4.11 Precision and Accuracy	52
4.11.1 Dry operation	52
4.11.2 Humidity Correction	53

4.11.3 Concentration Uncertainties	53
4.12 Spectrum Examples	54
4.12.1 Operational Radon Spectra	54
4.12.2 Thoron Spectra	55
4.12.3 Combination Spectra	56
4.12.4 Pathological Spectra	58
5 USING THE RAD8: MEASURING RADON AND THORON IN AIR	60
5.1 Introduction	60
5.2 Continuous Monitoring	60
5.2.1 Preparation	60
5.2.2 Purging	61
5.2.3 Test Location	61
5.2.4 Test Protocol	61
5.2.5 To Print Or Not To Print	63
5.2.6 Running the Test	63
5.2.8 Finishing the Test	63
5.2.9 Examining the Data	64
5.3 Sniffing	64
5.3.1 Why Sniff?	64
5.3.2 Locating Radon Entry Points	64
5.3.3 Preparation	64
5.3.4 Purging	64
5.3.5 Running the Test	65
5.3.6 Drilled Sampling Points	66
5.3.7 Spot Readings	66
5.4 Grab Sampling	67
5.4.1 Applicability	67
5.4.2 Preparation and Protocol	67
5.4.3 Taking the Sample	67
5.4.4 Analysis	67
5.5 Thoron Measurement	68
5.5.1 Thoron and Radon	68
5.5.2 Thoron Measurement Issues	68
5.5.3 Calculation and Interference Correction	69
5.5.4 Avoiding Longer-Lived Decay Products	69
5.5.5 Standard Thoron Setup, Thoron Calibration and Flow Rate	70
5.5.6 Calculating Sample Decay	70
5.5.7 Calculating Internal Measurement Chamber Concentration	70
5.5.8 Measurement Chamber Thoron Sensitivity Calibration	71
5.5.9 Setting up a Thoron Measurement	71
5.5.10 Sniff Protocol for Thoron Measurement	72
5.5.11 Thoron Measurements in Standard Pump Mode	73
5.6 Managing Background	73
5.7 Airflow Rate Limits	74

5.7.1 Maximum Airflow Rate	74
5.7.2 Minimum Airflow Rate	74
5.8 Harsh and Hazardous Environments	75
5.8.1 Dusty Environment	75
5.8.2 Radiation Hazard	75
6 USING RAD8 ACCESSORIES: TESTING SOIL AND WATER	76
6.1 Introduction	76
6.2 Radon in Water	76
6.2.1 The RAD H2O and Big Bottle Systems	76
6.2.2 The RAD AQUA Accessory	77
6.2.3 The Water Probe Accessory	77
6.3 Soil Gas Sampling	78
6.3.1 Application	78
6.3.2 The Soil Gas Probe Accessory	78
6.3.3 Soil Gas Probe Preparation	78
6.3.4 Running the Test	79
6.3.5 Interpreting the Data	79
6.4 Emission Measurements	79
6.4.1 Application	79
6.4.2 Open-Loop Configuration	79
6.4.3 Closed-Loop Configuration	80
6.4.4 Very Low Emission Rates	80
6.4.5 Bulk Emissions	80
6.4.6 Surface Emission	81
6.5 The DRYSTIK	82
7 MAINTENANCE	83
7.1 Accessories - Usage and Care	83
7.1.1 Desiccant	83
7.1.2 Laboratory Drying Unit	83
7.1.3 Small Drying Tube	84
7.1.4 Cascading Drying Tubes	84
7.1.5 Filters	85
7.1.6 Batteries	86
7.2 RAD8 Operating Ranges	86
7.3 Service and Repair	87
7.3.1 Calibration	87
7.3.2 Repair	87
7.3.3 Shipping	87
7.4 RAD8 Quality Assurance	90
7.4.1 Spectrum	90
7.4.2 Spill Factor (C Window to B Window)	90
8 TROUBLESHOOTING	91

8.1 Readings	91
8.1.1 No Counts	91
8.1.2 Excessive Uncertainty In Reading	91
8.2 Relative Humidity High	91
8.3 Water Ingress	92
8.4 Capture RAD8 Detection Failure	93
Appendix 1: THERMAL PRINTER	94
A1.1 Thermal Printer Description	94
A1.1.1 General Printer Information	94
A1.1.2 Printer Features	94
A1.1.3 Power Switch	94
A1.1.4 Indicator LEDs	94
A1.1.5 Push Buttons	95
A1.1.6 Sensors	95
A1.2 Thermal Printer Operation	97
A1.2.1 Precautions	97
A1.2.2 Self-Test	97
A1.2.3 Setup Mode	97
A1.2.4 Using the Printer	99
A1.3 Thermal Printer Maintenance	99
A1.3.1 Battery Installation	99
A1.3.2 Paper Installation	99
A1.3.3 Cleaning the Printer	100
A1.3.4 Cleaning the Print Head	100
A1.4 Thermal Printer Specifications	101
Appendix 2: RAD8 Specifications	102
Appendix 3: Glossary of Terms	104

INTRODUCTION

The RAD8 is a highly versatile instrument that can form the basis of a comprehensive radon measurement system. It may be used in many different modes for different purposes. This manual adopts a progressive approach, starting with a step-by-step description of how to get readings for a) real-time monitoring, and b) sniffing. Next comes a more detailed description of the many features of the instrument and how to access them. The rest of the manual covers a whole range of topics, in somewhat arbitrary order. We recommend that, as soon as possible, you read the entire text, just so that you will have an idea of what there is. While you can start to make good measurements on the first day of ownership of the RAD8, it can take months to master the subtleties of radon and thoron behavior, and to appreciate the full capabilities of the instrument.

We have tried to make the RAD8 manual easy to use, with a useful table of contents. Please let us know how well we have succeeded. If there are some topics inadequately covered, please tell us. We will issue updates from time to time.

1 GETTING STARTED: YOUR FIRST DAY WITH THE RAD8

This section will cover unpacking the RAD8, reviewing the package contents, safety fundamentals, examining the controls and ports on the RAD8 front panel, and setting up the instrument to perform basic radon tests.



1.1 Unpacking

First make sure you have everything. Take the materials out of the packing boxes and check that you have all the items shown in the illustrations below, or on the packing list enclosed with the shipment. If anything is missing, please email DurrIDGE immediately at service@durrIDGE.com, or call us at (+1) 978-667-9556.

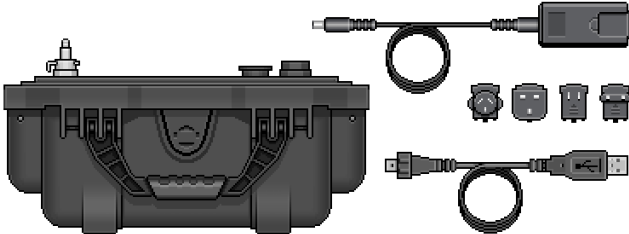
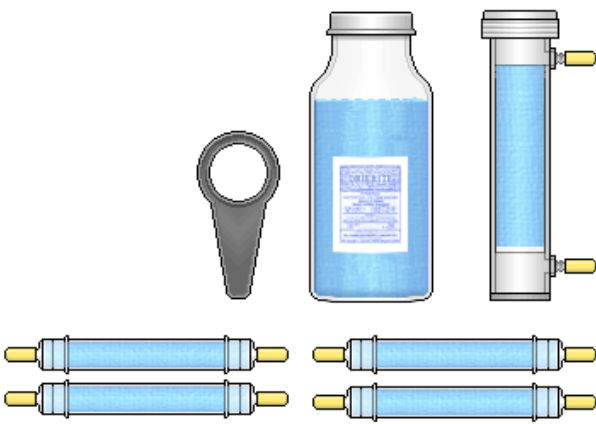
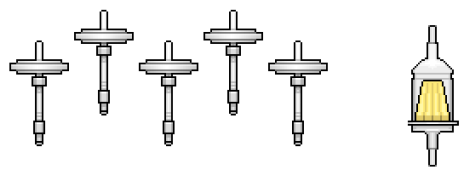
RAD8 Packing List

	<p>RAD8 and Case Accessories</p> <ul style="list-style-type: none">• RAD8 electronic radon detector• 12V adaptor with 4 plugs• USB-A to Mini-B cable
	<p>Drying Tubes and Desiccant</p> <ul style="list-style-type: none">• Laboratory Drying Unit• Opener tool for drying unit• 5 lbs desiccant• 4 Small Drying Tubes
	<p>RAD8 Filters</p> <ul style="list-style-type: none">• 5 RAD8 air sample filter assemblies• 1 Dust filter

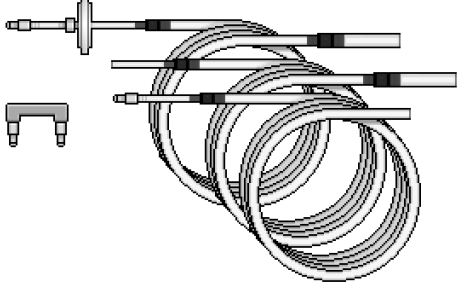
Packing List continued on next page.

	<p>Vinyl Tubing Set (3ft x 3)</p> <ul style="list-style-type: none"> • From Drying Unit to Sample In port • From air sample to Lab Drying Unit • From Sample Out port to exhaust <p>Removable Tubing Bridge</p> <ul style="list-style-type: none"> • From Pump Out port to Detector In port (Comes pre-inserted in correct position)
	<p>RAD8 Documentation Bundle</p> <ul style="list-style-type: none"> • RAD8 User's Manual • Additional documentation • DurrIDGE Product Information

1.2 General Safety Instructions

The RAD8 measures radon and thoron activity concentration in air. For your own safety and the proper operation of the RAD8, do not allow liquid to be pulled into the inlet. If you intend to measure radon in water using one of DurrIDGE's water-air exchange accessories, please consider also using the DurrIDGE Water Switch accessory to prevent water ingress. Although the entire RAD8 enclosure is sealed for water resistance, it is important to prevent liquids from entering any of the ports on the front panel, because once inside the RAD8, liquids may damage the RAD8's detector. The front panel's electrical connectors are water resistant, but are best protected when they have their rubber caps inserted or their mating cables installed. Always replace caps when the connectors are not in use.

If liquid does get into the air sample path, please disconnect the power cord, turn off the RAD8, and follow the instructions in Section 8.4, Water Ingress. It will be necessary to return the RAD8 to DurrIDGE for repair.

Do not use your RAD8 if the instrument is damaged or malfunctioning. Please call or email the DurrIDGE service department to receive instructions on what to do about the problem.

Replace a frayed or damaged power cord immediately. Electrical equipment may be hazardous if misused. Do not open or attempt to repair the RAD8. The detector has an internal high voltage supply that can generate more than 2,500V. The battery module in the RAD8 contains lithium ion cells. This battery module is not user replaceable. Keep the RAD8 away from children.

1.2.1 Air Travel

The U.S. Federal Aviation Administration advises that devices containing lithium ion batteries should be kept in carry-on baggage. If such devices are packed in checked baggage, they must be turned completely off, protected from accidental activation, and packed so they are protected from damage. Since the RAD8 contains lithium ion batteries, it should be in carry-on baggage whenever possible. DURRIDGE IS NOT LIABLE FOR ANY DAMAGES RESULTING FROM IMPROPER PROCEDURES RELATING TO AIR TRAVEL. THIS IS ENTIRELY THE RESPONSIBILITY OF THE USER.

An MSDS sheet, issued by the battery manufacturer, is enclosed with this manual. A copy of this sheet should be carried and presented to airport security as necessary when traveling by air with a RAD8.

1.3 Taking a Look



The RAD8 Professional Electronic Radon Detector

1.4 Starting a Two-Day Test

The radon testing guidelines published by the U.S. Environmental Protection Agency stipulate that home radon tests should be taken for a minimum of 48 hours. The RAD8 can provide dependable results more rapidly, but for the purpose of learning to use the instrument, we will initiate a standard 48-hour test.

1.4.1 Connecting the RAD8 Hardware

You will need the RAD8 and power cord, the Laboratory Drying Unit (the large tube of desiccant, with a screw cap at the top), one of the six included air inlet filter assemblies, and the piece of tubing with a 5/16" ID segment at one end and a 1/8" ID segment at the other end. A thermal printer may be connected to one of the RAD8's two USB-A ports using the included printer cable as described on the next page, but it is optional.

Carefully remove both plastic caps from the Laboratory Drying Unit (you will need them later, to reseal the unit). Next connect the tubing containing the inlet filter assembly. The sleeved end of the tubing should be connected to the end of the Laboratory Drying Unit farthest from the screw cap, and the end with the inlet filter assembly should click in to the Sample In port on the RAD8. Finally, click the Tubing Bridge into place between the Pump Out and Detector In ports. The air sampling system is now set up for the measurement.

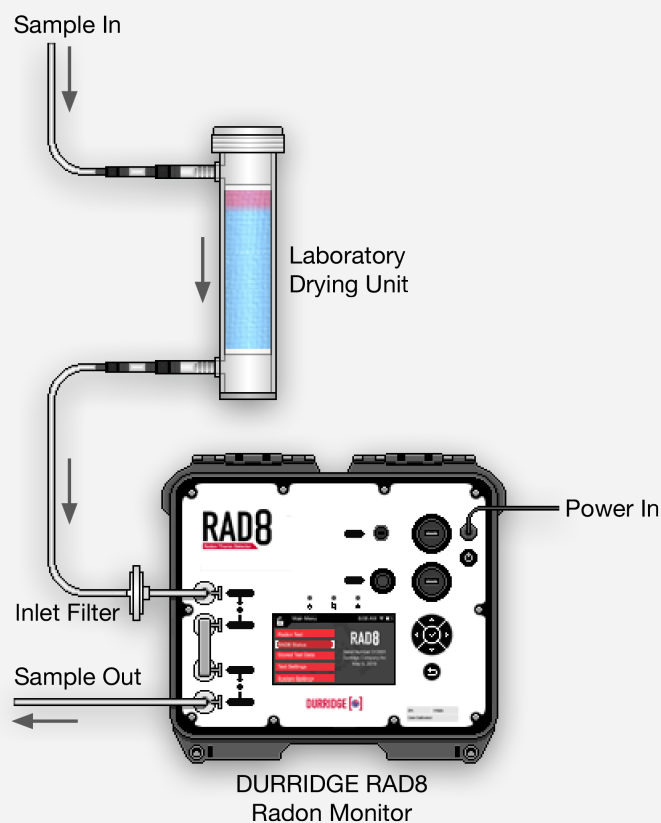

RAD8 Standard Configuration



Tubing Port Connections Required

The RAD8's Sample In, Pump Out, Detector In, and Sample Out ports are sealed off except when tubes are connected to them. It is important to insert a tube into each connector whenever the RAD8 pump is providing airflow, or else too much pressure will build up inside the instrument. The end of each tube contains a connector that clicks into the port.

The Sample In and Sample Out ports can be opened by clicking standard tubing connectors into each of them. To open the Pump Out and Detector In ports, snap the Tubing Bridge accessory into place. It should span the gap between the two ports. The Tubing Bridge accessory comes pre-installed in the correct position by default.

In the illustration at left, tubes are properly connected to all four tubing ports, and the RAD8 is ready for use. ***Under normal operating conditions, the RAD8 must be operated with all four ports populated to avoid damaging the instrument.***

1.4.2 Setting Up the RAD8

Connect the RAD8 power supply to the DC Power In Port at the top right corner of the RAD8 front panel, and turn on the RAD8 using the nearby power button. As the instrument starts up, the touchscreen will display the Main Menu as shown below.

On first starting up, the RAD8's clock should be set. The RAD8 can be configured to set the date and time automatically when a Wi-Fi connection is available. Using either the touchscreen controls or the front panel buttons to the right of the display, enter the **System Settings** menu and select the **Wi-Fi** option. Next select the desired wireless network and enter the Wi-Fi password as necessary. Use the back arrow button ↶ at the top left corner of the screen or the corresponding physical back arrow button to return to the **System Settings** menu.

Next choose **Date/Time**, and specify the Date, Time, and Time Zone, using the ^ and v arrows to increment values as needed. Use the Auto menu to set the clock to the correct time by default whenever the Wi-Fi connection is available. Note however that the time zone and daylight savings time must be set manually, even when a Wi-Fi connection is available. The time zone is set to Coordinated Universal Time (UTC) by default. When finished, use the back arrow ↶ to return to the Main Menu.

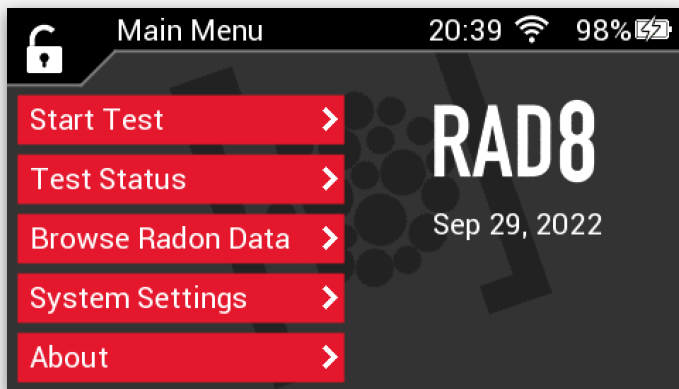

Main Menu Screen

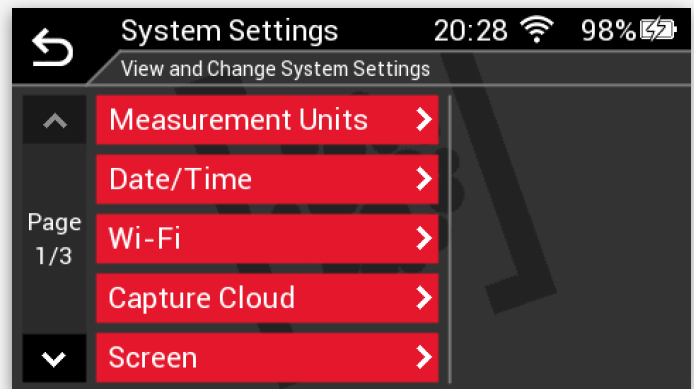

System Settings Screen

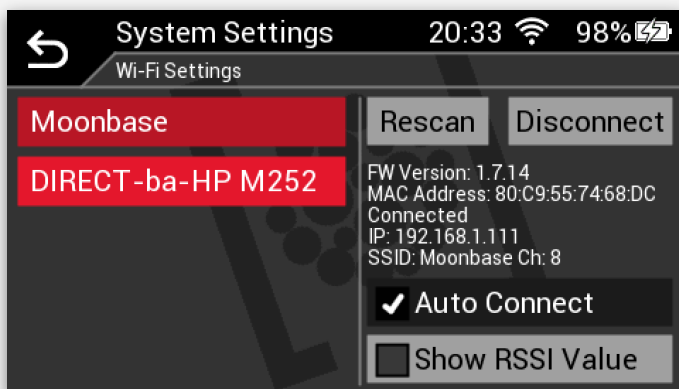

Wi-Fi Settings Screen

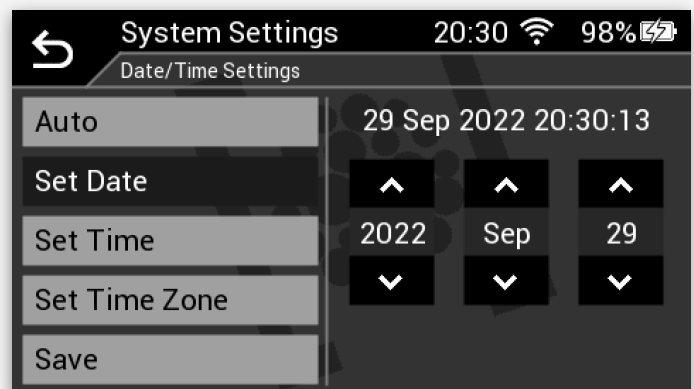

Date/Time Settings Screen



The RAD8's waterproof **front panel buttons** include a four-way directional pad for selecting menu items, a checkmark button ✓ for confirming the selection, and a back button ↶ for returning to the previous menu. Any function that can be performed using the controls on the RAD8's interactive touchscreen can also be performed using the front panel buttons. The resistive touchscreen can be operated with a stylus or gloved fingers, but the front panel buttons may be easier to use with bulky gloves or by feel.

1.4.3 Purging the RAD8

Next the air inside the RAD8 should be purged. This practice removes any radon that may be left over from an earlier test, to prevent it from influencing the measurement. Using the touchscreen controls or the front panel buttons, choose **Start Test**. The Select Protocol screen will appear. Choose **Purge**. Finally, press the **Start Purge** button. The RAD8 pump will start. Let the purging operation continue for five minutes, then press the **Stop Purging** button on the touchscreen, or press the ✓ button at the center of the directional pad.

1.4.4 Starting the 2-Day Test

After five minutes have passed, use the RAD8 touchscreen or front panel buttons to return to the first page of the **Start Test** menu. Then choose **Preset Protocols** and select the **2-Day Test** protocol. Next press the **Run** button. The RAD8 will begin

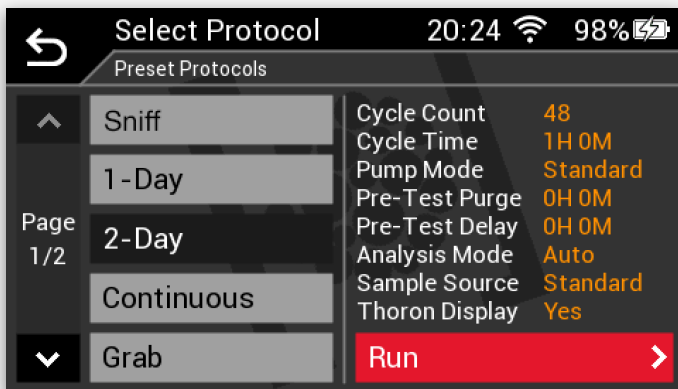

Select Protocol Screen

The Select Protocol screen contains numerous preset protocols, in addition to a Manual Config option at the top of the list, plus a Purge RAD8 command on the third page. The scroll bar is used to move between pages.

When a protocol is selected its details appear on the right side of the screen. Use the red button at the bottom right to confirm the selection.

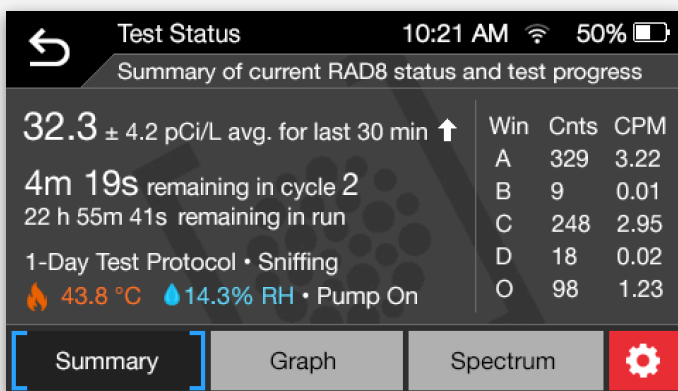

Test Status Screen showing the Summary Panel

The Test Status screen contains three panels: Summary, Graph and Spectrum. Use the buttons at the bottom of the screen to toggle between the panels.

The Gear button at the bottom right connects to the Live Test Options screen, which is used to change test parameters in real time, as explained in Section 2.4.

measuring radon, and the Test Status Screen will display the progress of the measurement, as shown below.

You are now monitoring the radon level right where you are. Use the buttons at the bottom of the Test Status Screen to switch between the real-time Summary, Graph, and Spectrum panels. Every hour, the Graph Panel will be updated, with a new data point appearing on the graph.

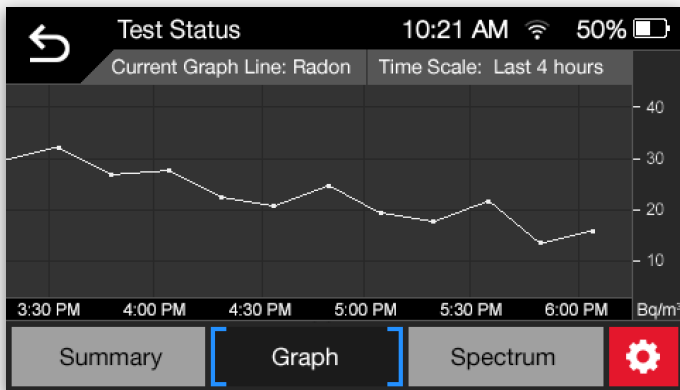

Test Status Screen showing the Graph Panel

The Test Status Graph panel displays a real-time graph of the RAD8 data that has been recorded during the current test. For more information, see Section 2.4, *Monitoring the Test Status*.

1.4.5 Completing the Test

If you allow the RAD8 to complete the entire 2-Day test, the graph will expand to a total of 48 data points. (The stored test data will be saved for later viewing, as described in Section 2.5.) Additionally, if the RAD8 printer is connected and enabled a test summary will be printed, containing the average radon concentration for the test, a bar chart of the individual readings, and a cumulative alpha energy spectrum.

To end the radon test before the 48-hour test is completed, return to the main menu using the ↶ button, and choose **Stop Test**. The data that has been collected will be stored in the RAD8 memory, and it will remain available for viewing, printing, or saving to a computer or to Capture Cloud. These operations will be covered later in this manual.

You may turn off the RAD8 by pressing the power button on the front panel. A Shut Down Confirmation screen will appear. Use the touchscreen or front panel buttons to confirm. Pressing the power button a second time will also shut down the RAD8. If you shut down the RAD8 while it is still actively measuring radon, the radon test will stop and the data will be saved to the RAD8's memory before the instrument turns off.



The terms **Test** and **Cycle** appear often in this manual. A RAD8 **Test** contains all the radon and thoron data that is recorded between the time the RAD8 starts and when it stops. A Test consists of multiple **Cycles**, which are typically between 5 minutes and 2 hours in duration. Each Cycle produces an individual radon reading which appears as a data point on a graph. The 2-Day Test described in this section involves recording 48 1-hour Cycles. The Sniff Test described in the next section has no predetermined length, so it consists of an ongoing sequence of 5-minute Cycles, ending only when the Test is manually stopped.

1.5 Starting a Sniff Test

Sniffing lets you make quick, qualitative surveys of radon and thoron levels. It may be used to search for radon entry points. There are some advantages in sniffing for both thoron and radon at the same time, (see Section 4.13.3), so that is the procedure described here.

You will need the same equipment as for the 2-day test, above, except that a Small Drying Tube should be used, instead of the Laboratory Drying Unit. Also, for portability, you may remove the external power from the RAD8, and run the RAD8 on battery power. If you have not already done so, set the RAD8 clock, as described above.

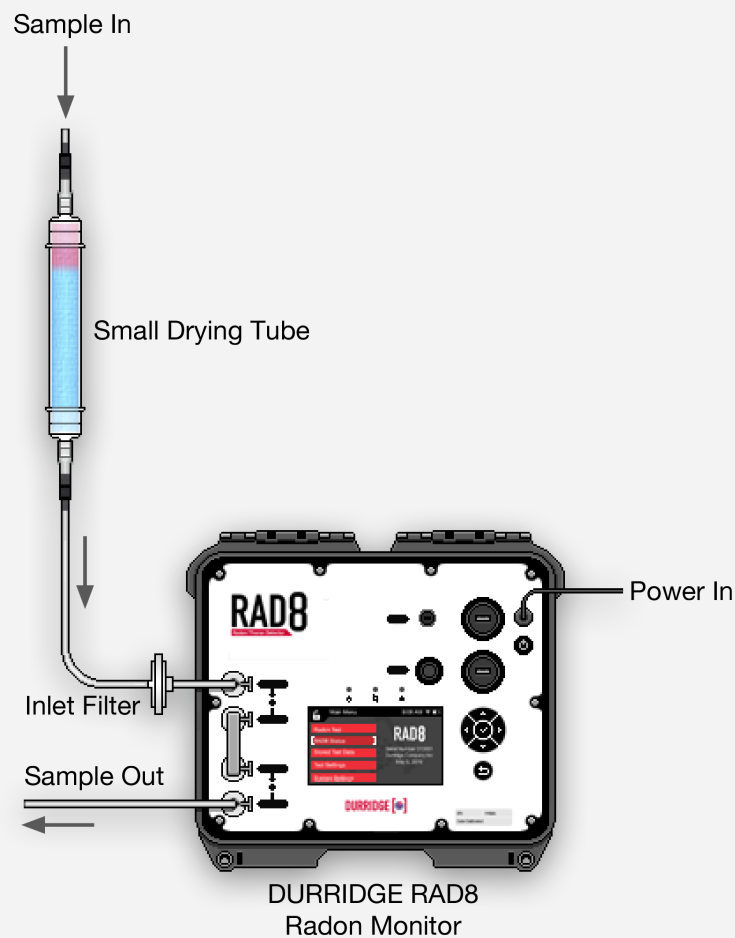

RAD8 Sniff Configuration



Warning: **Tubing Port Connections Required:** As with the Normal Configuration described in Section 1.4.1, the RAD8 Sniff Configuration shown above requires tubing connections in each of the RAD8's four air ports. The Tubing Bridge accessory should snap into place, spanning the gap between the Pump Out and Detector In ports.

Next perform the following series of steps:

1. Make sure the inlet filter assembly is connected to the tubing. The end of the filter should be pushed into the the $\frac{1}{8}$ " inner diameter (ID) segment of tubing.
2. Carefully remove both plastic caps from the Small Drying Tube (you will need them later, to reseal the Small Drying Tube). Attach the wider 5/16" ID end of the tubing to one end of the Small Drying Tube.
3. Click the inlet filter assembly into the Sample In port of the RAD8, and click an exhaust tube into the Sample Out port. The air sampling system is now set up for the measurement. While testing, you can use the Small Drying Tube as a wand, to collect your air sample from the location of interest.
4. Plug in the RAD8 and power it on.
5. If the thermal printer accessory is used, set up the printer as described earlier in Section 1.4.3.
6. Purge the RAD8 for approximately five minutes, as explained in Section 1.4.4.
7. From the Main Menu, choose **Start Test** and select the **Sniff Test Protocol**, which is found on the third page of the list of Protocols. The RAD8 will begin operating, sniffing for both radon and thoron.

As the test proceeds, the RAD8 will display thoron readings in addition to radon readings. Instrument and environmental parameters are shown on the Test Status Summary screen. If the optional thermal printer is connected, it will print out a reading every five minutes,

Note that the radon daughter, polonium-218, has a 3-minute half-life. After moving the RAD8 to a new location, it will take about 12 minutes for the count rate in Window A to reach equilibrium with the new radon concentration. So not until after the third 5-minute Cycle will the reading indicate the new level. However, the thoron daughter, polonium-216, has a very short half-life (150 ms), so the response of the RAD8 to thoron is virtually instantaneous. For thoron, the first 5-minute Cycle is as good as any other.

Thoron will only be found very close to radon entry points. That, together with its fast response, makes thoron sniffing an excellent sleuth for radon entry points. For more information, see the Sniffing For Thoron article at <https://durrige.com/support/technical-resources/application-notes/>.

As with the two-day test described earlier, the Sniff test can be terminated by choosing **Stop Test** from the Main Menu.



Unless otherwise stated, all uncertainties in this manual are 2-sigma ($k=2$) **statistical uncertainties** (as distinguished from *systematic uncertainties*). This is based on a 95% confidence interval, meaning the true concentration value will fall within the specified uncertainty range 95% of the time. Large uncertainty values may be reported when attempting to measure low radon concentrations quickly. Sometimes the uncertainty figure may approach or even exceed the base concentration value, for example "1.6 \pm 2.3 pCi/L") This can be avoided by increasing the Cycle Time to extend the test duration.

2 BASICS OF RAD8 OPERATION

This section will explain how to navigate the RAD8's user interface to perform operations including starting a radon test, viewing the test status, modifying test settings, configuring custom test protocols, and changing system settings. For instructions on choosing the appropriate test protocols and techniques based on particular goals and conditions, please see Section 5.

2.1 Input Controls

The RAD8 user interface consists of the touchscreen and the accompanying physical front panel buttons, which may be used interchangeably with the touchscreen controls. The front panel buttons include a directional pad with four arrows $\wedge \vee \langle \rangle$ plus a central checkmark button \checkmark and a back button \curvearrowright .

When navigating menus, the \checkmark button is used to choose the selected menu item. To return to the previous menu, press the \curvearrowright button at the top left corner of the touchscreen, or press the corresponding physical \curvearrowright button. When you return all the way to the top level Main Menu, the \curvearrowright button is replaced with a lock icon \mathfrak{L} , which leads to the Lock Screen, securing the RAD8 with an optional passcode.

Back Button

Used to navigate to previous menu
Normally appears as Back icon \curvearrowright
Uses Lock Icon \mathfrak{L} on Main Menu

Directional Pad

Contains four Arrow buttons $\wedge \vee \langle \rangle$
for selecting menu options and adjusting
editable values
Checkmark button \checkmark is used to choose
the selected menu option

Selected menu option
Item is bracketed when
selected using Arrow
Buttons on Directional Pad

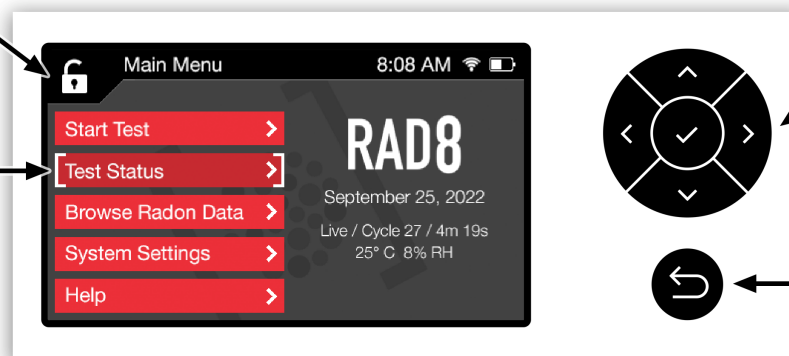

Back Button

Physical Back Button performs
same function as Back Button at
top left corner of touchscreen

RAD8 Input Control Functionality

2.2 Main Menu Organization

The five buttons on the Main Menu screen lead to submenus used for starting a test, monitoring the current test status, browsing stored radon data, configuring system settings, and viewing information about the RAD8. These options will be explored in this section.

RAD8 Main Menu Options

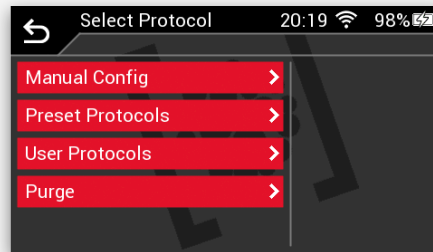
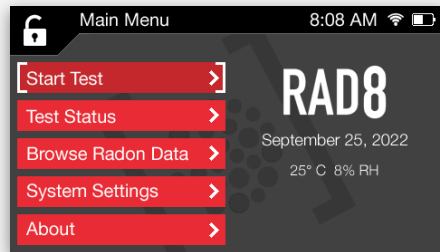

Start Test

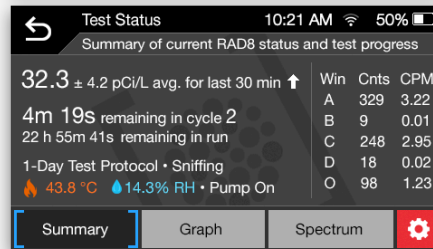

Test Status

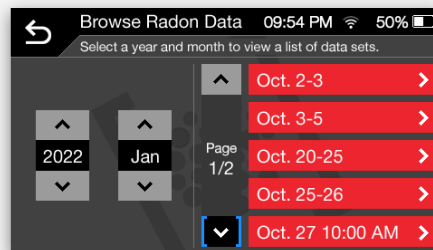

Browse Radon Data

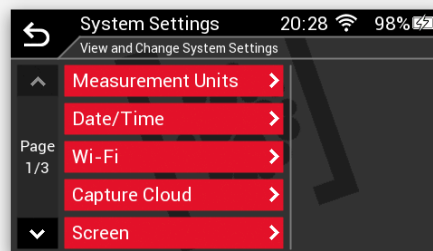

System Settings

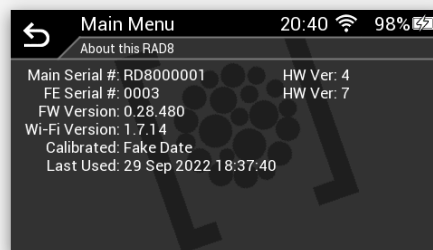

About This RAD8



The colors of the buttons on the RAD8 touchscreen indicate their function.

Red buttons always connect to another screen. For example the red Start Test button advances to the Select Test Protocol Screen. A red button can be triggered simply by touching it, or by selecting it with the Directional Pad and pressing the \checkmark button on the front panel.

Gray buttons do not connect to another screen. They are used to increment or decrement adjustable values, such as a time duration or a cycle count. They are also used for scroll bar arrows that let you browse through lists, and to toggle between panels within a screen, as seen on the Test Status screen, which consists of three selectable panels.

2.3 Starting a Radon Test

2.3.1 Overview

A RAD8 Test includes a particular number of Cycles, each of a specific duration, plus a specified air pumping behavior, as well as several other testing parameters. The test may use a preset collection of these parameters, called a Protocol, or it may use a series of manually specified parameters. A collection of commonly used testing Protocols is built into the RAD8, and it is also possible to add custom User Protocols. This section will explain how to start a Test by choosing an existing Protocol, and by specifying a series of individual parameters.

To begin, go to the Main Menu and choose **Start Test**. The Select Test Protocol screen will appear.

2.3.2 Setting the testing protocol

The Select Test Protocol screen offers several options, including a list of Preset Protocols as shown on the rolling page. Select Preset Protocols, and use the scroll bar to navigate up and down through the pages, and choose the desired Protocol. The table below shows the parameters of each built-in Protocol. The meaning of each parameter is explained in Section 2.3.4, Test Parameters.

Table 2.3.2 Built-In RAD8 Testing Protocols

Protocol Name	Cycle Count	Cycle Time	Total Test Duration	Pump Mode	Pre-Test Purge	Pre-Test Delay	Analysis Mode	Sample Source	Thoron Display
Sniff	—	5 min.	Indefinite	On	—	—	Rapid	Standard	Visible
1-Day	48	30 min.	24 hrs.	Standard	—	—	Auto ²	Standard	Visible
2-Day	48	1 hr.	48 hrs.	Standard	—	—	Auto ²	Standard	Visible
Continuous	—	2 hrs.	Indefinite	Standard	—	—	Auto ²	Standard	Visible
Grab	4	5 min.	20 min.	Off ¹	5 min.	5 min.	Rapid	Standard	Hidden
H ₂ O 40 ml	4	5 min.	20 min.	Off ¹	5 min.	5 min.	Rapid ³	H ₂ O 40 ml	Hidden
H ₂ O 250 ml	4	5 min.	20 min.	Off ¹	10 min.	5 min.	Rapid ³	H ₂ O 250 ml	Hidden

¹ The pump switches from On to Off after the pre-test purge is complete.

² The Analysis Mode switches from Rapid to Precise after 3 hours.

³ The sensitivity is scaled with respect to the water volume and the air-water partition coefficient.

Once a protocol has been selected, the RAD8 will begin the radon test, and the Test Status Screen will appear. This screen consists of multiple status panels, and it will be explained in detail in Section 2.4, Monitoring the Test Status.

2.3.3 Configuring individual test parameters

If none of the RAD8's built-in testing protocols are suitable for a particular radon test, choose the Manual Config option in the Select Protocol menu. This will allow you to set each test parameter, including the Cycle Count, Cycle Time, Pump Mode, Pre-Test Purge

duration, and more. Note that the list of parameters extends onto a second menu page. Each of these parameters is explained below.

To save a custom protocol consisting of a particular combination of test parameters, choose the User Protocols option from the Select Protocol menu.

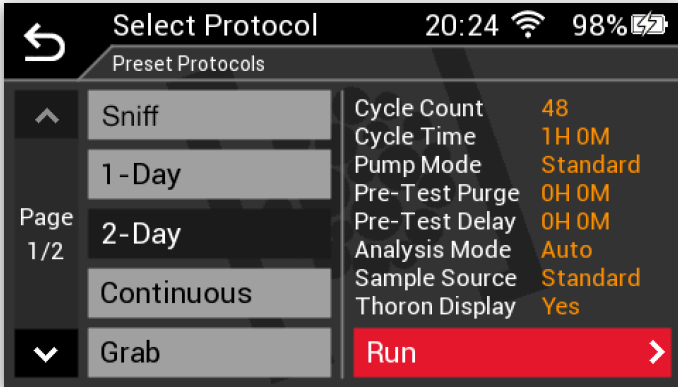

Preset Protocols Screen

To run a built-in Protocol, choose the Preset Protocols option from the Test Protocol menu. The available choices will appear in a multi-page list. Use the Run button to begin a test with the selected Protocol.

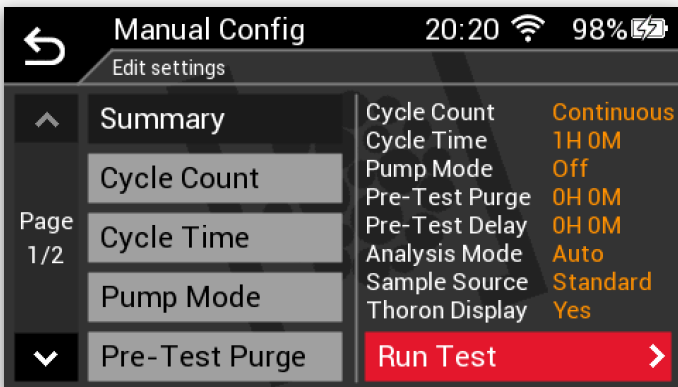

Manual Config Screen

If none of the built-in Protocols contain the desired combination of test parameters, choose Manual Config from the Test Protocol menu. This makes it possible to individually specify each test parameter.

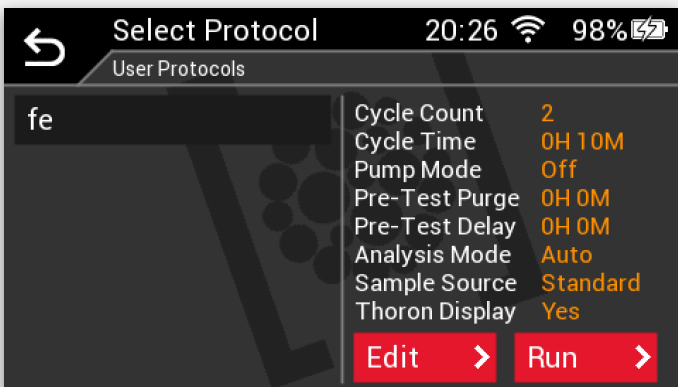

User Protocols Screen

Custom Protocols consisting of user-specified parameters may be edited and run using the User Protocols menu.

2.3.4 Test Parameters

Pre-Test Purge Duration: The duration of pump activity before the RAD8 begins recording the first Cycle in the test. The pre-test purge clears the RAD8 of any residual radon and airborne daughter particles that may be left over from an earlier test.

Cycle Time: The duration of each Cycle in the test. A Cycle is represented by one data point on a graph. Longer Cycle Times yield lower statistical uncertainty for each data point, but causes the data points to be spaced out further on the graph, which is not suitable when the radon concentration fluctuates rapidly.

Cycle Count: The number of Cycles in the test. This can be set to a finite number, or the Test may be allowed to continue indefinitely until it is manually concluded. The duration of the test is equal to the Cycle Time multiplied by the Cycle Count.

Analysis Mode: The RAD8 operates in one of several Analysis Modes, including Rapid, Precise, and Automatic, plus additional modes facilitating the measurement of radon in water. These modes are explained further in Section 2.3.5.

Pump Mode: The RAD8 pump can be set to either On, Off, or Standard. The pump modes are explained below, in Section 2.3.6.

Thoron Reporting: The RAD8 measures thoron as well as radon. Note that this typically requires the Standard Thoron Setup, as described in Section 5.5.9.

2.3.5 Analysis Modes

The RAD8 Analysis Mode is a key attribute of the testing protocol, determining which of the RAD8's alpha energy spectrum channels inform the calculation of the reported radon activity concentration. When measuring radon in water, the Analysis Mode additionally determines which sensitivity factor is applied with respect to the known water sample volume and air-water partition coefficient. The available Analysis Modes include Rapid, Precise, and Auto, plus radon-in-water modes for use with particular water sample sizes.

Rapid Analysis Mode: This mode is used when you want to follow rapid changes of radon concentration. In Rapid Analysis Mode, the RAD8 achieves rapid response to changing radon levels by focusing on the 3-minute polonium-218 alpha peak in the A Window, calculating the radon concentration on the basis of this peak alone.

Precise Analysis Mode: This mode is used to achieve higher statistical precision by summing counts in both the A and C Window alpha peaks. These peaks are generated by the alpha decays of the short-lived radon progeny polonium-218 and polonium-214, respectively.

Automatic Analysis Mode: This mode automatically switches from Rapid Analysis Mode to Precise Analysis mode after three hours of continuous measurement. The earliest part of the test will have the benefit of the Rapid Analysis Mode's quick response, while the latter parts of the test will benefit from the Precise Analysis Mode's superior statistical precision.

RAD H₂O modes: There are two RAD H₂O modes, which are used for measuring the radon concentrations in specific water sample sizes of 40 mL and 250 mL. These modes require the Durrige RAD H₂O water accessory kit, which aerates the water sample, bringing its radon into equilibrium with a closed air loop, which the RAD8 samples. Since the amount of radon that can enter the air loop depends on the water-to-air volume ratio, each sample size calls for a particular sensitivity scale factor when calculating radon-in-water concentrations.

It is recommended that Automatic Analysis Mode be used for all screening tests and any tests to measure the average radon concentration over a period of time. With Automatic Analysis Mode there is no need to throw away the first three hours of data, or to calculate adjustments to correct for disequilibrium. The mean concentration reported in the test summary should accurately reflect the actual mean. Rapid Analysis Mode should be used where the goal is to follow, and measure, rapid changes in the radon concentration. The radon-in-water modes should only be used when measuring bottled water samples with the aid of the RAD H₂O.

2.3.6 Pump Modes

The RAD8's air pump can operate in three different modes: On, Off, and Standard.

On Mode: When the RAD8 pump mode is set to On, the pump runs continuously whenever the RAD8 is actively conducting a radon test. (When a test is not being conducted the pump will remain off unless the RAD8 has been set to purge.) The preset Protocols dictate that the pump remain On while sniffing for radon, and while measuring thoron, due to its short half-life.

Off Mode: When the RAD8 pump is set to Off, the instrument will not actively draw air into the measurement chamber. The pump may be Off if an external pump is being used, or if the RAD8 is known to already contain an air sample that was pumped in previously. The latter scenario applies when using Grab protocol or the radon-in-water protocols.

Standard Mode: When the RAD8 pump is set to Standard, it will switch on and off according to a predetermined pattern that allows for sufficient sampling of air while conserving the battery charge and reducing pump wear (two minutes on, three minutes off).

Several of the RAD8's built-in testing protocols use the Standard pump mode, which is recommended for routine radon testing. The On mode is used for Rapid Protocol.

2.3.7 Stopping a test

To stop a RAD8 test, go to the Main Menu and choose the **Stop Test** button. The RAD8 will prompt you to confirm that you want to stop the test. Note that when an in-progress test is stopped, the current incomplete Cycle will not be preserved, but all of the preceding completed Cycles will be saved.

2.3.8 Purging the RAD8

Purging the RAD8 involves running the device's pump to clear the sample chamber of radon gas and airborne short-lived radon progeny as quickly as possible. Outdoor air is usually adequate for this purpose. Purging should be conducted before recording a test, and optionally after a test is complete.

The inlet filter assembly and Laboratory Drying Unit should be connected to the RAD8. Ten minutes of purging activity is usually sufficient for bringing the background down after exposure to moderate amounts of radon.

In order to dry out the RAD8 without using up much desiccant, connect the hoses from the RAD8 to the Laboratory Drying Unit in a closed loop. When the pump runs, the same air will circulate repeatedly through the desiccant. This procedure will efficiently remove residual moisture from the RAD8. However this does not introduce any fresh air, and so it does not significantly change the radon level in the instrument.

To begin a purge, go to the Main Menu and choose Start Test, then choose the Purge RAD8 command. You will be prompted to start the purge, upon which the RAD8 pump will start, and the touchscreen will display the humidity level. To stop the purge, use the Stop Purging button.

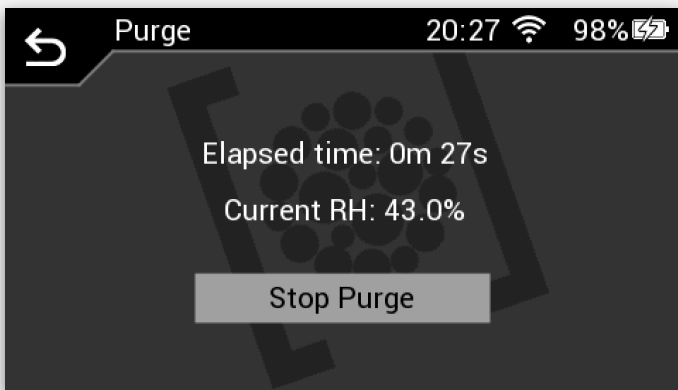

Purging the RAD8

Purging the RAD8 flushes out and refreshes the air sample in the measurement chamber. While purging is underway, the elapsed time and humidity level can be monitored in real time.

2.4 Monitoring the Test Status

To monitor the status of a test that is already in progress, go to the Main Menu and choose the **Test Status** button. This brings up the Test Status screen, which consists of three main panels: the Summary Panel, Graph Panel, and Spectrum Panel. The selection buttons at the bottom the screen are used to switch between these panels. Use either the on-screen buttons or the < and > arrows on the Directional Pad to move between these panels. These panels are described on the next page.

The Gear Menu at the bottom right corner of the display connects to the Live Test Options screen, which is used to change the Cycle Count, Analysis Mode, Pump Mode, and Thoron Reporting while the RAD8 test is proceeding. Note that not every RAD8 operating parameter can be changed in the middle of a test.

The Live Test Options screen is also used to adjust the visual parameters of the real-time graph on the Test Status screen. The graph line visibility options are used to choose whether the graph displays lines for radon, thoron, temperature, barometric pressure, and/or relative humidity. It is also possible to specify whether the labels on the graph's vertical axis automatically cycle between the scales for each of the visible elements. If automatic cycling is disabled it is still possible to switch from one scale to the next simply by tapping the graph image on the touch screen.

Finally, the Live Test Options screen can be used to save the test data to Capture Cloud on demand. Note that it is also possible to configure the RAD8 to automatically log data to Capture Cloud as it is being recorded, as described in Section 2.6.10.

Capture Cloud requires a Wi-Fi internet connection. The Wi-Fi settings can be specified using the **System Settings** button on the Main Menu. If a connection is not available during the test, the data can be uploaded to Capture Cloud at a later time.

Although any RAD8 can save data to the cloud, browsing the cloud data requires a computer with Durridge's Capture software and a Capture Cloud account. For more details see <https://durridge.com/software/capture-cloud/>.

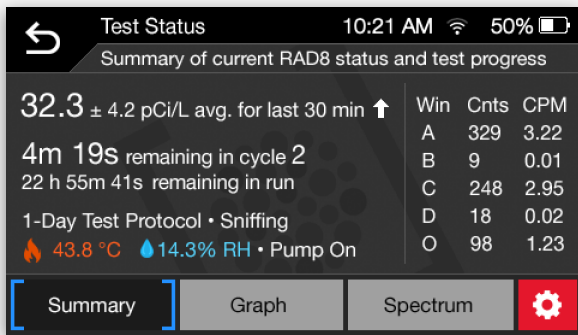

Test Status Summary Panel

The Test Status Summary panel displays real-time information about the Test in progress, including the current radon concentration, the time remaining in the current Cycle and Test, the current RAD8 Protocol, and the current temperature, humidity, and pump activity. The right side of the screen summarizes the number of counts and the counts per minute in each of the spectrum windows for the current Cycle.

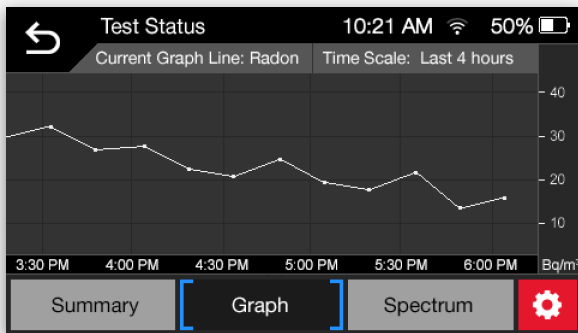

Test Status Graph Panel

The Test Status Graph panel displays a real-time graph of the RAD8 data that has been recorded during the current Test. Radon, thoron, temperature, and humidity each appear as a separate graph line. The labels on the vertical axis can be set to automatically change at regular intervals, revealing the scale used for each graph line. These parameters, along with the graph time scale, can be set using the Gear menu.

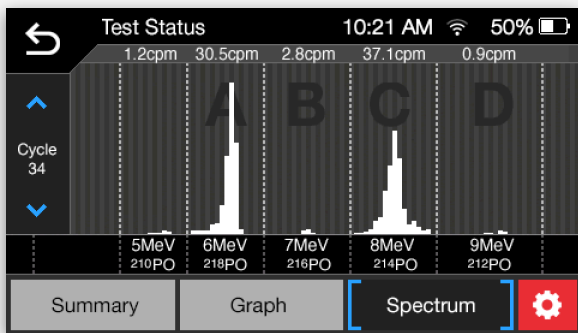

Test Status Spectrum Panel

The Test Status Spectrum panel displays a histogram revealing the distribution of alpha decay events across the RAD8's energy windows. The peak in Window A represents new radon, B represents new thoron, C represents old radon, and D represents old thoron. The RAD8's Analysis Mode determines which peak(s) inform the calculation of radon concentrations. A histogram representing the entire test is displayed by default. Press the ∇ and \blacktriangle front panel buttons to view through histograms representing each individual cycle within the Test.

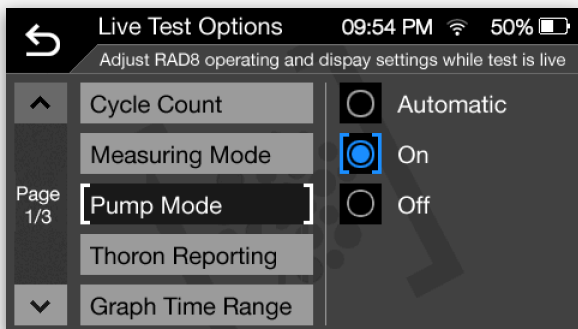

Live Test Options Screen

The Gear menu activates the Live Test Options screen, which is used to change the RAD8's operating parameters while a test is active. It is also used to adjust the appearance and time range of the real-time Graph, to print Test and Cycle summaries on demand, and to save the test data to Capture Cloud.

When finished configuring the settings, press the \hookrightarrow button to return to the Test Status screen.

2.5 Browsing Stored Radon Data

When the RAD8 conducts a radon test, the test data is automatically saved to the instrument's local storage, allowing it to be viewed, printed, or exported at any time. These operations are covered in this section.

2.5.1 Viewing Stored Data

To view stored data, first go to the Main Menu and choose **Browse Radon Data**. The Browse Radon Data screen will appear, allowing you to view a list of data files from a specified time period. The left side of the screen contains date selector controls for choosing the desired year and month, and the right side of the screen contains a list of radon data files from the selected month. If the list contains more than five items a scroll bar can be used to move up and down between multiple pages of results.

After choosing a result from the scrollable list, the Test Details screen will appear. This screen contains Summary, Graph, and Spectrum panels, which are similar to the panels seen when monitoring the status of a live test. See Section 2.4 for details on live test monitoring.

Use the **<** and **>** front panel buttons or use the controls at the bottom of the touchscreen to move between the panels. When the Spectrum panel is visible, it will show a histogram of alpha particle energy, representing the entire test content by default. Histograms for specific Cycles may also be displayed. Press the **∨** front panel button to view the first cycle's histogram. Press it again to view the second cycle's histogram, and so on. Press the **∧** button to move in the opposite direction through the list of cycles.

To access another data set, press the **↶** button to return to the Browse Radon Data screen.

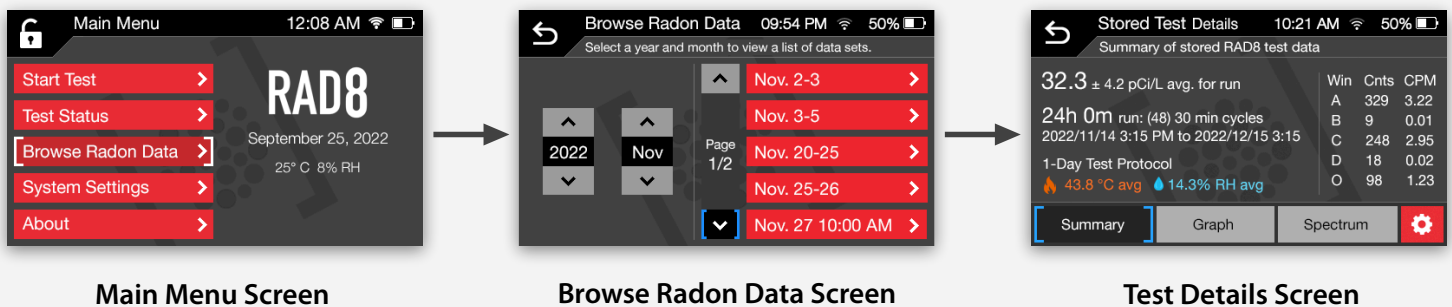

The Gear Menu at the bottom right corner of the screen connects to the Stored Test Options screen, which is used to adjust the graph and spectrum parameters, print test and cycle summaries, and save the data to Capture Cloud. (The RAD8 can also be configured to save data to Capture Cloud automatically, using the System Settings menu.)

Graph line visibility options are provided for choosing whether the graph displays lines for radon, thoron, temperature, and/or humidity. It is also configured to set the automatic cycling of the labels on the graph's vertical axis, so that the axis displays the scales for each of the visible elements, one at a time.

The Gear Menu also makes it possible to upload the data file to Capture Cloud, if it was not automatically uploaded while the RAD8 was performing the test. This option requires a Wi-Fi internet connection.

2.6 Configuring System Settings

The System Settings button in the Main Menu provides access to numerous settings affecting the RAD8's functionality and visual output. These are explained below.

2.6.1 Measurement Unit Settings

The RAD8 can report radon and thoron concentrations using either Picocuries per liter (pCi/L) or Becquerels per cubic meter (Bq/m³). Picocurie is the favored unit of radon activity in the U.S., while Becquerel is the favored unit in the rest of the world. 1 pCi/L equals 37 Bq/m³.

Temperatures may be reported using either the Celsius (°C) or Fahrenheit (°F) scale.

Barometric pressure readings may be reported using either millibars (mbar) or inches of mercury (inHg).

To choose which units are used to display concentrations, temperatures and barometric pressures, go to the System Settings screen and choose **Measurement Units**.

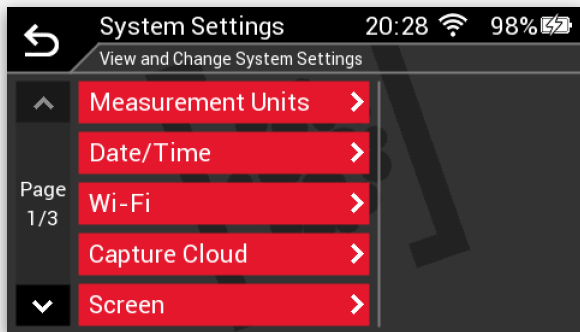

System Settings Screen

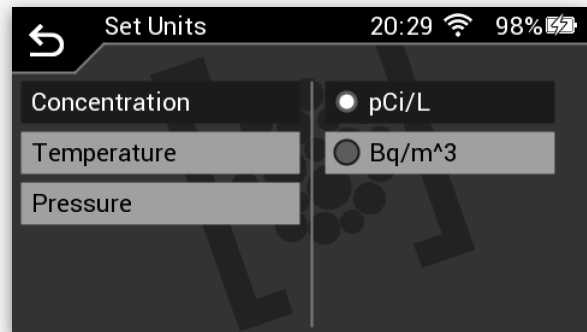

Set Units Screen

2.6.2 Clock Settings

An accurate clock setting ensures that each RAD8 data point contains the correct timestamp. To set the clock, go to the System Settings screen and use the **Set Date**, **Set Time**, and **Set Time Zone** panels. The RAD8 will remember the specified clock settings when it is powered off, even if the main battery is depleted. Therefore it will typically be necessary to adjust these settings only when daylight savings time starts or ends, or when the RAD8 is transported to a different time zone.

When a Wi-Fi connection is available, the clock may be set automatically using a time server. However the time zone and daylight savings time options must be set manually.

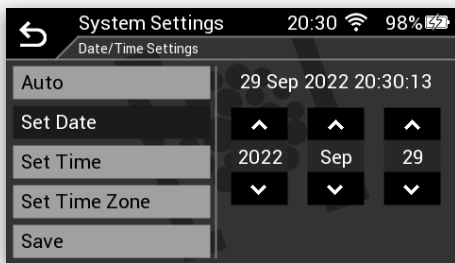

Set Date Screen

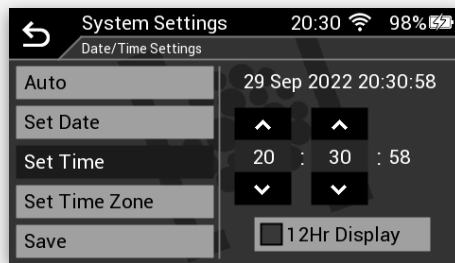

Set Time Screen



Set Time Zone Screen

2.6.3 Audio Settings

The RAD8 can produce audible feedback when an alpha particle is detected, when buttons are pressed, and/or when each test cycle is completed. To configure these options go to the System Settings Screen and choose **Audio Settings**.

If the Detection Sound is turned On, the RAD8 will emit a chirp when a particle is detected, much like the familiar Geiger counter. But unlike a Geiger counter, the pitch of the chirp depends on the energy of the alpha particle. A trained ear can distinguish "old" radon from "new" radon by the sound of the chirps. Thoron detection events produce the highest pitch. When sniffing for radon it will be possible to recognize an entry point by the rapid-fire chirping produced by the RAD8.

If the Button Press Sound is On, the RAD8 will play a clicking sound each time a button press is registered on the touchscreen.

If the End of Cycle Sound is turned On, the RAD8 will play a chime sound each time it reaches the end of a Cycle.

The Volume control is used to adjust the audio output level. It can be set to any value between 1 (nearly silent) and 11 (maximum volume).

2.6.4 Printing Settings

When the optional thermal printer is connected to the RAD8, the instrument can print measurement summaries upon the completion of each Cycle and/or Test. Additionally, RAD8 device information can be printed when the unit is powered on. To configure these options go to the RAD8's System Settings Screen and choose **Printing Settings**.

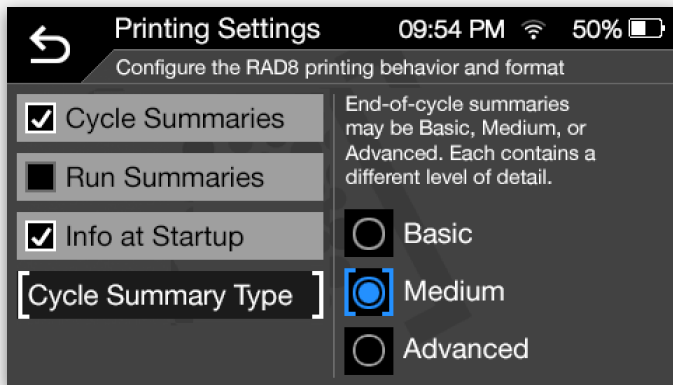

Printing Settings Screen

The Printing Settings Screen contains two pages of options. It is used to specify whether summaries are printed upon the completion of each cycle and/or test, and to set the formatting of cycle summaries. This screen also includes a button for aborting an in-progress print operation, and for specifying whether information about the RAD8 is automatically printed each time the instrument is powered on. This information can also be printed on-demand.

The Printing Settings Screen contains a set of buttons and checkboxes. If the Cycle Summaries box is checked, the RAD8 will print measurement information upon the completion of each Cycle, formatted in accordance with the specified Cycle Summary Type. There are three Cycle Summary Type options: Basic, Medium, and Advanced. If the Basic option is selected, Cycle Summaries will be concise. The Medium Summary option adds information on the distribution of particle detections between the four main windows, A, B, C, D, and all the rest, O (for "other"). Each window corresponds to a particular range of alpha particle energies within the spectrum.

The Advanced Summary option includes this additional information as well as a histogram illustrating the aforementioned distribution, aka the Spectrum. Examples of each Cycle Summary Type are shown below.

Cycle Summary Types

```
RAD8 Cycle 1 Rapid
Radon 2.69 ± 0.73 pCiL
FRI MAY 17 2022 19:41
26.8°C RH:7% Batt:100%
```

Basic Cycle Summary

```
RAD8 Cycle 1 Rapid
Radon 2.69 ± 0.73 pCiL
FRI MAY 17 2022 19:41
26.8°C RH:7% Batt:100%
Total Counts: 42
A: 0.53±0.08 cpm 47.3%
B: 0.02±0.02 cpm 1.7%
C: 0.52±0.08 cpm 46.4%
D: 0.01±0.02 cpm 0.9%
0: 0.04±0.03 cpm 3.6%
```

Medium Cycle Summary

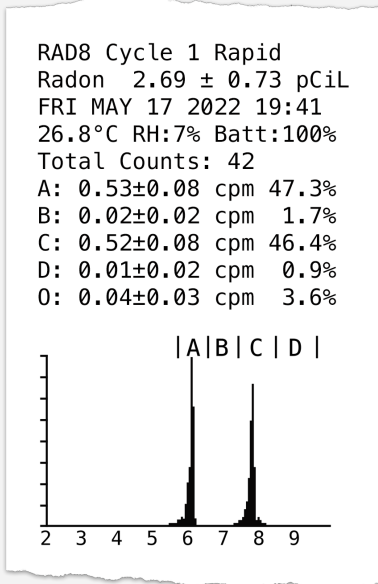

Advanced Cycle Summary

In the above sample printout the measured radon concentration is 2.69, and 0.73 is the two-sigma statistical uncertainty. PCiL indicates that the measurement unit is picocuries per liter. “Rapid” shows that, for this reading, only the Po-218 decays are being counted. (After three hours, the Analysis Mode automatically changes from Rapid to Precise if using the 1-Day or 2-Day Test Protocol.) The third line of the printout contains the date and time, while the fourth shows the temperature and humidity inside the RAD8 measurement chamber, and the battery’s state of charge.

If the Test Summaries box is checked, then when a test concludes the RAD8 will print relevant details pertaining to the entire test. This summary includes an average of the radon concentrations, the highest value, lowest value, and standard deviation. These are followed by a bar chart, showing the variation of radon concentration from cycle to cycle throughout the test. Finally, it prints a cumulative spectrum, showing the distribution of energy of all the alpha decays counted during the test. This spectrum is very informative; it gives a good indication of the condition of the instrument and the quality of the measurement. It is a useful habit to look at the cumulative spectrum from time to time. Section 3.12.4 gives some examples of pathological spectra to look out for.

Note that even if the RAD8 is not configured to print cycle and test summaries as tests are being conducted, these summaries can still be printed at a later time, when browsing data from within the Stored Test Details Screen.

The Printing Settings Screen includes a Print RAD8 Info at Startup button, which causes the printer to output basic information about the RAD8 each time the instrument is powered on. This information includes the instrument's serial number, firmware version, hardware revision number, and calibration date. This information can also be printed on demand by pressing the accompanying Print RAD8 Info Now button.

It is good practice to allow the RAD8 to print this information when it starts up, because it provides a header listing the instrument identity and setup as follows:

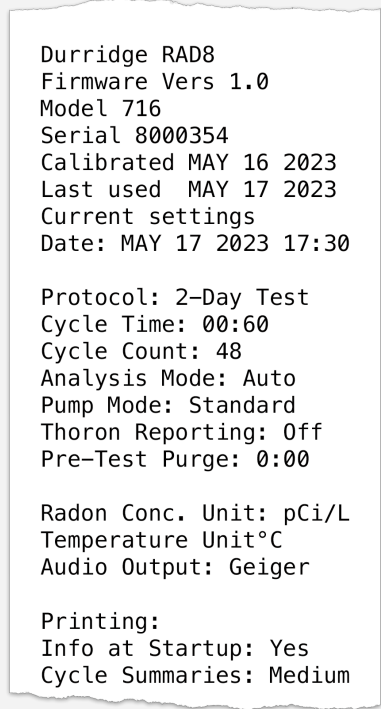

```
Durridge RAD8
Firmware Vers 1.0
Model 716
Serial 8000354
Calibrated MAY 16 2023
Last used MAY 17 2023
Current settings
Date: MAY 17 2023 17:30

Protocol: 2-Day Test
Cycle Time: 00:60
Cycle Count: 48
Analysis Mode: Auto
Pump Mode: Standard
Thoron Reporting: Off
Pre-Test Purge: 0:00

Radon Conc. Unit: pCi/L
Temperature Unit°C
Audio Output: Geiger



Printing:
Info at Startup: Yes
Cycle Summaries: Medium
```

RAD8 Info Printout

2.6.5 Display Settings

The RAD8 touchscreen can be configured with a specified brightness, and a specified delay before the screen turns off to save power. To set these preferences, go to the System Settings screen and choose Display Settings.

2.6.6 Locking and unlocking the RAD8

To lock the RAD8, go to the Main Menu and press the lock icon , at the top left corner of the touchscreen. Alternatively press the physical  button. The lock screen displays the date and time, but it does not reveal the current radon concentration or other potentially sensitive information. If the RAD8 is locked while performing a radon test, the test will continue in the background, but it will not be possible to monitor the test from the Lock Screen.

If a passcode has been assigned in the System Settings, it will be necessary to enter the code to return to the Main Menu and regain access to RAD8 functionality. The passcode is a multi-digit number that you must remember to avoid losing access to the RAD8. If you forget the passcode, it will be necessary to contact Durridge. We will provide instructions to help you regain access to your RAD8.

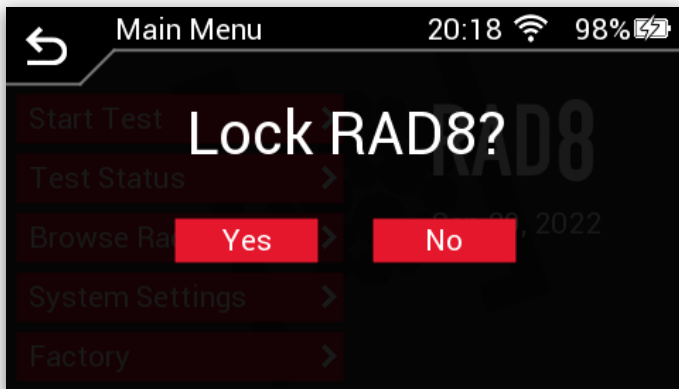

Lock RAD8 Prompt



RAD8 Locked Screen

2.6.7 Graph View Settings

The RAD8 Graph View can be configured to display radon and/or thoron, the air sample temperature, the air sample relative humidity, and the barometric pressure. It is also possible to set whether the graph's Y scale labels automatically or manually cycle between the specified elements, and the rate at which the labels cycle. This can occur every 5 seconds, every 10 seconds, or manually. To set these preferences, go to the System Settings screen and choose `Graph View Settings`.

2.6.8 Spectrum View Settings

The RAD8 Spectrum View can be configured to display a histogram for either a single cycle, or the cumulative data from an entire test. To do this, go to the System Settings screen and choose `Spectrum View Settings`.

2.6.9 Managing Custom Test Protocols

To create, delete, rename, or modify a custom test protocol, go to the System Settings screen and choose `Manage Custom Protocols`. Each custom protocol contains the following user-configurable parameters: Analysis Mode, Cycle Duration, Cycle Count, Radon Source, Pump Mode, and Pre-Test Purge Duration. When starting a radon test, the option to run a Custom Protocol is offered along with the option to run a Preset Protocol and a Manual Configuration.

2.6.10 Managing Storage Space

If the RAD8's ample internal storage space ever fills up, it can be restored by deleting data. Make sure the data has been copied to a computer or to Capture Cloud, then use the System Settings menu to erase the data stored in the RAD8.

2.6.11 Wi-Fi Settings

The System Settings menu can be used to choose a Wi-Fi network. When the RAD8 is connected to Wi-Fi, data can be copied to a computer running Capture, and uploaded to Capture Cloud. The Wi-Fi Settings screen is shown in Section 1.4.2. This screen contains options for selecting a network, rescanning for available networks, auto-connecting at startup, and disconnecting.

2.6.12 Capture Cloud Settings

The System Settings menu is also used to enable or disable the automatic saving of RAD8 data to Capture Cloud. When a RAD8 test finishes, the data can be automatically uploaded to the cloud, and Capture Cloud subscribers who have access to the instrument's data will be able to browse the data using the Capture application on Windows and macOS computers.

2.6.13 Firmware Update Settings

The System Settings menu is also used to check for any available firmware updates, whenever a Wi-Fi connection is active. The RAD8's operating firmware is being continuously improved with new features for added power and convenience, and DurrIDGE recommends always installing the latest available updates. The instrument can be configured to check for updates automatically at regular intervals.

2.7 Viewing RAD8 Device Information

To view information about the RAD8, go to the Main Menu and choose the About button. The screen will display the following information:

RAD8 Serial Number: The unique identification number for this RAD8.

Model Number: The RAD8 hardware model number.

Firmware version: The version of the firmware on the RAD8. The firmware may be updated when new versions become available. Update notifications may appear automatically, depending on the System Settings.

Date of manufacture: The date on which the RAD8 was first assembled.

Date last calibrated: The date when the RAD8 was last calibrated by DurrIDGE. It is recommended that the instrument be recalibrated annually.

Total running time: The total amount of time the RAD8 has spent conducting radon tests, including time spent with the pump both on and off.

Total pump time: The total amount of time the RAD8 has spent with the pump active, including pump activity during radon tests and purging.

Most recent test: The date of the most recently recorded radon test that has been saved in the RAD8's memory.

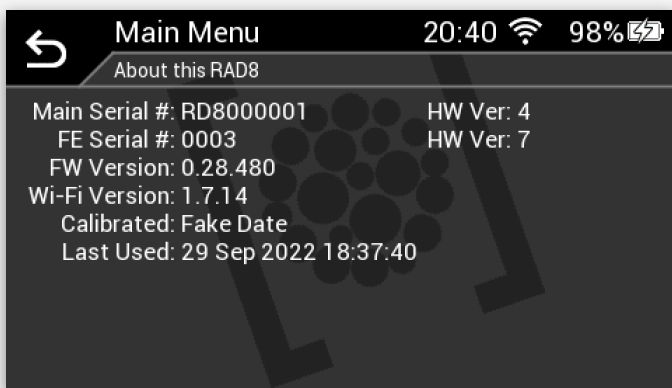

About This RAD8 Screen

The About This RAD8 Screen lists important RAD8 information including the serial number, which should be reported to DurrIDGE when arranging for the the instrument to be calibrated or repaired.

3 COMPUTER CONNECTIVITY

3.1 Computer Connection Basics

The RAD8's Wi-Fi and USB connectivity allow you to transfer radon data to your computer and to Capture Cloud, which is DurrIDGE's cloud-based service for storing, organizing, sharing, and analyzing radon data. DurrIDGE provides a free software application for Windows and macOS called Capture, which makes it easy to download radon data from the RAD8, monitor the instrument's status in real time, browse radon data sets stored on your computer and on the cloud, graph the data, apply corrections to account for environmental factors, and export data for analysis in other software.

An overview of the Capture software is provided in Section 6.2, and the full program documentation is available at https://durrIDGE.com/documentation/capture_help/. This information is also accessible from within the Capture, using the Help menu. For troubleshooting RAD8 detection problems in Capture, please refer to the program documentation or to Section 8.7, Capture RAD8 Detection Failure, in this manual.

3.1.1 Connecting the RAD8 to a Computer via USB

The RAD8 can be connected to a computer using the included USB-A to USB Mini-B cable, with the USB-A end of the cable connected to the computer, and the USB-B end connected to the RAD8's COM port. It may be necessary to install FTDI driver software on your computer. The driver software is widely available online, including at the DurrIDGE website: <https://durrIDGE.com/software/software-drivers/>.

It is recommended that the RAD8 remain plugged into an external power source to prevent its battery from draining while it is connected to the computer, particularly if the computer will be used to monitor the RAD8 status for an extended period of time.

Multiple RAD8s can be connected to a computer simultaneously, with each plugged into a separate USB port. A USB hub can be used to increase the number of available ports.

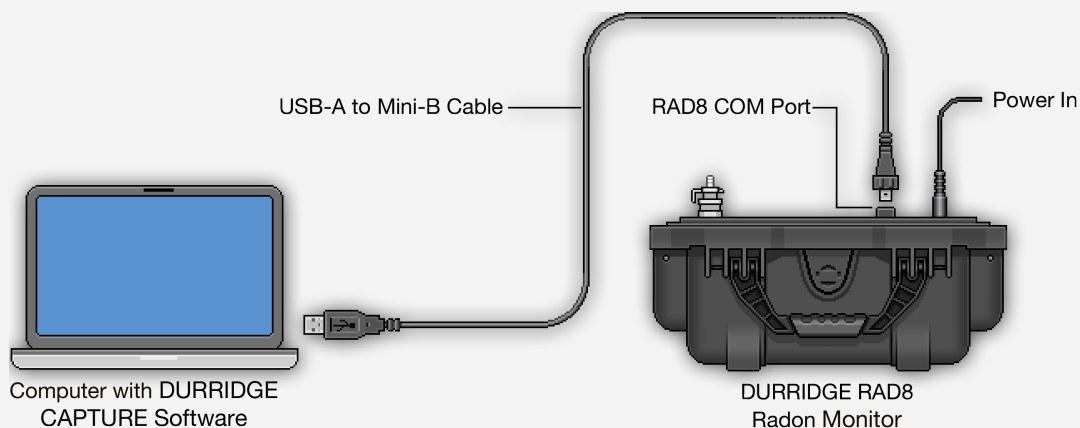

Connecting the RAD8 to a computer via USB

3.2 Capture Software

3.2.1 Introduction to Capture

Capture simplifies the transfer of data from the RAD8 to a computer. It also provides a wealth of graphing and data analysis options, plus the ability to export data to other programs for further review. Additionally, Capture can be used to browse RAD8 data that has been saved to Capture Cloud, which is a subscription-based service for securely storing, organizing, and sharing RAD8 data. Capture software can be downloaded for Windows or macOS from <https://durridge.com/software/capture/>.

3.2.2 Capture Installation

Durridge's Capture software can be downloaded for Windows or macOS from <https://durridge.com/software/capture/>. To install Capture on Microsoft Windows, launch the installer program and follow the prompts to install the necessary components on your computer. Once installed, a Capture shortcut will typically appear in the Start Menu and on the Windows desktop. To install Capture on a macOS computer, open the downloaded .dmg disk image file and drag the Capture application into the Applications folder on the hard drive. Capture will provide notifications when updates are available, and the software will facilitate the downloading of new versions as needed.

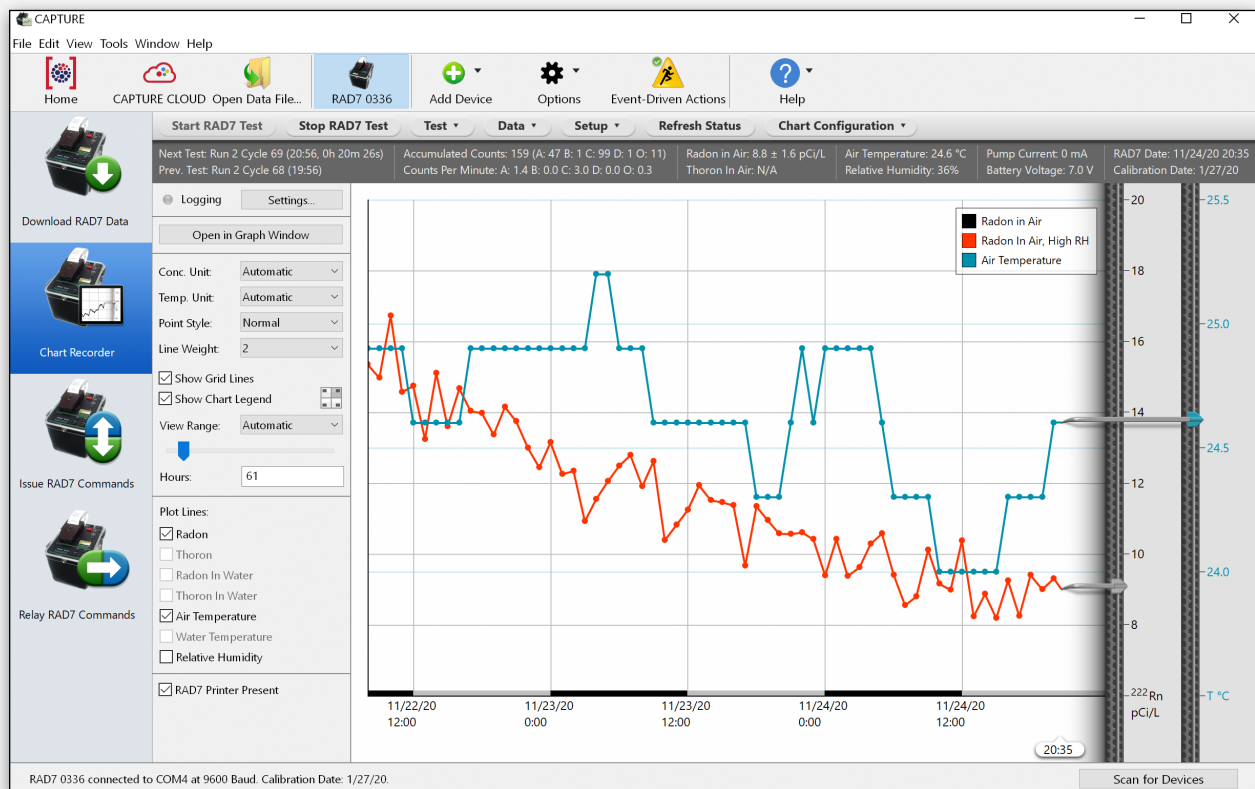

Capture Software running on Microsoft Windows

3.2.3 Feature Summary

Capture's capabilities fall into four main categories: downloading RAD8 data, graphing and analysis, real-time RAD8 monitoring, and Capture Cloud. An overview of each is described below.

3.2.4 Downloading RAD8 Data

Capture's primary function is to download radon data. Once connected to a RAD8, the program can be instructed to download a particular Test or range of Tests. When a download operation is complete, the data is saved to a file on the computer using the .rd8 file name extension. The data may also be displayed in a Graph Window.

In addition to being able to download data from RAD8s connected directly to the computer, Capture can obtain data from RAD8s connected via a local network or the internet.

3.2.5 Graphing and Analysis

Capture's Graph Window displays radon, thoron, temperature, and humidity data. Navigation controls make it possible to select the data points within a specific date range and zoom in to the selected region for a closer look.

Accompanying the graph display is a statistics panel showing information about the point nearest to the cursor and the points within the selected region, as well as the points comprising the entire data set.

A spectrum display appears in another panel, providing an indication of the changes that occur within the RAD8 as a Test progresses.

RAD8 Profiles based on device calibration data may be applied to graphs to improve the accuracy of the data shown. Additionally, calculated radon concentration values may be corrected with respect to temperature, humidity, and other variables. Any problematic data records will be examined by Capture's comprehensive error catching system, and the error details will be reported to the user.

Capture supports the exporting of both raw RAD8 data and corrected RAD8 data in a number of formats, for use in spreadsheets and other analysis tools. Summary reports may also be generated, providing general overviews of the collected data.

3.2.6 Real-Time RAD8 Monitoring

Capture is capable of monitoring multiple local and remote RAD8s simultaneously in a Chart Recorder, displaying status details and plotting radon concentrations in real time as they are recorded. A statistics panel is automatically refreshed as new data arrives at regular intervals.

In addition to being able to track the state of each connected RAD8, it is also possible to issue menu commands, performing such tasks as starting and stopping tests and setting the device protocol. Nearly all of the functionality available via the RAD8's physical controls is also accessible from within Capture's graphical user interface, eliminating the need to physically access the instrument when monitoring it from a remote location.

As stated above, it is suggested that users examine the complete Capture documentation, which is available from within the program's Help menu. If Capture fails to detect a connected RAD8, troubleshooting solutions can be found in Section 8.7 in this manual.

3.2.7 Capture Cloud

Capture Cloud is a subscription-based service that offers secure storage for RAD8 data files and makes it easy to organize, analyze, and share data with your colleagues. The RAD8 is capable of automatically uploading its data to Capture Cloud as it is being recorded, or later at a time specified by the user. Data may also be uploaded to Capture Cloud from within the Capture software for Windows and macOS.

When using the Capture desktop software, users can browse radon data files generated by any RAD8s that are owned by the organization(s) to which the user belongs. Search queries may be issued to locate specific RAD8 record sets based on criteria such as date range, organization, device serial number, and custom data tags. Users can be easily added or deleted by an organization administrator upon request. Additionally, shared data can be made accessible to authorized Capture Cloud users.

When a RAD8 data file is selected from a list of search results, a preview appears immediately. The data can then be analyzed and edited using Capture. Any modifications made to the data file, such as changes to the device profile or the specified radon measurement method, can be saved to disk or back to the Capture Cloud server, so that the data is presented correctly when viewed by any user.

Subscribing to Capture Cloud unlocks premium Capture software features including Event-Driven Actions, which make it possible to configure Capture to perform specified sequences of actions when particular events occur. For example, send an email notification when the radon concentration gets too high. Or, change a DRYSTIK's pumping behavior when the humidity level exceeds a specified threshold. For more information on Capture Cloud, including subscription details, instructional videos, and written documentation, see <https://durridge.com/software/capture-cloud/>.

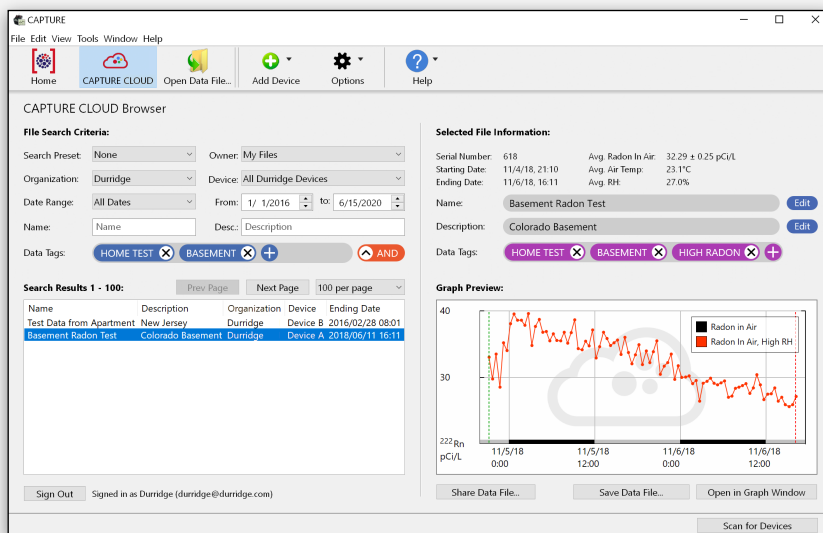

The Capture Cloud Browser

Durridge's Capture software for Windows and macOS offers the Capture Cloud Browser, which provides access to all of the RAD7 data files that you and the other members of your organization have saved to your Capture Cloud account. It also provides access to any data files that have been specifically shared with you.

The browser consists of controls for specifying search parameters, a list containing search results, and a graph previewing the selected result.

4 BASICS OF RAD8 TECHNOLOGY: HOW IT WORKS

This section deals with a number of fundamental facts concerning radon and thoron, their measurement in general and their measurement, specifically, with the RAD8. It is not necessary to master the underlying physics to become proficient in the use of the instrument, but some understanding of what is happening is helpful.

4.1 Radon and Thoron Decay Chains

When the earth was formed, billions of years ago, there were likely many radioactive elements included in the mix of material that became the earth. Three, of interest, have survived to this day, namely uranium-235, uranium-238, and thorium-232. Each has a half-life measured in billions of years, and each stands at the top of a natural radioactive decay chain.

A radioactive element is unstable. At some indeterminate moment, it will change to another element, emitting some form of radiation in the process. While it is impossible to predict exactly when the transformation of an individual atom will take place, we have a very good measure of the probability of decay, within a given time slot. If we started with a very large number of atoms of a radioactive element, we know quite precisely how long it would take before half those atoms had decayed (though we could not identify the decaying atoms individually, beforehand). This time interval is called the half-life of that particular element.

A natural radioactive transformation is accompanied by the emission of one or more of alpha, beta or gamma radiation. An alpha particle is the nucleus of a helium atom. It has two protons and two neutrons. Thus an 'alpha decay' will reduce the atomic number by two and reduce the atomic weight by four. A beta particle is an electron, with its negative charge. Thus a beta decay will increase the atomic number by one and leave the atomic weight unchanged. A gamma ray is just a packet of energy, so a gamma decay by itself would leave both the atomic number and atomic weight unchanged.

A decay chain is a series of distinct transformations. A uranium-235 nucleus goes through a series of 11 transformations to become stable lead-207. A thorium-232 nucleus goes through 10 transformations to become stable lead-208. And a uranium-238 nucleus goes through 14 transformations to become stable lead-206.

All three of these natural decay chains include isotopes of radon. Radon-219, or "actinon", is a link in the uranium-235 chain. You will probably never encounter actinon in indoor air, due to its scarcity and short half-life. Radon-220, or "thoron", is part of the thorium-232 decay chain. You will sometimes encounter thoron in indoor air, particularly near radon entry points, and, more often, in soil gas. Radon-222, is the familiar "radon", and it is part of the uranium-238 decay chain. You will almost always be able to detect radon-222 in indoor air, outdoor air, and soil gas.

The radon isotope is the first element, in each of the decay chains, that is not a metal. It is in fact an inert "noble" gas, so it can escape any chemical compound that its parent (radium) may have been in, and diffuse into the air.

The thoron and radon decay chains below reveal the parts of the thorium-232 and uranium-238 decay chains that include inert radioactive gasses and their short-lived progeny.

It may be noted that only alpha decays change the atomic weight, and then only in steps of four. Therefore the atomic weights of all the members of the radon-220, thoron, decay chain are divisible by four, while none of the radon-222 are.

Radon Decay Chain

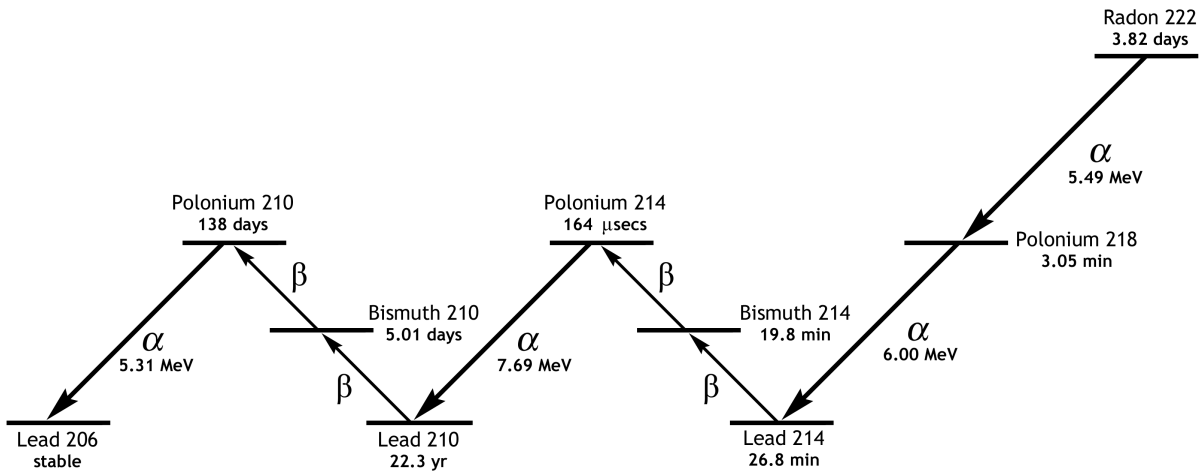

Thoron Decay Chain

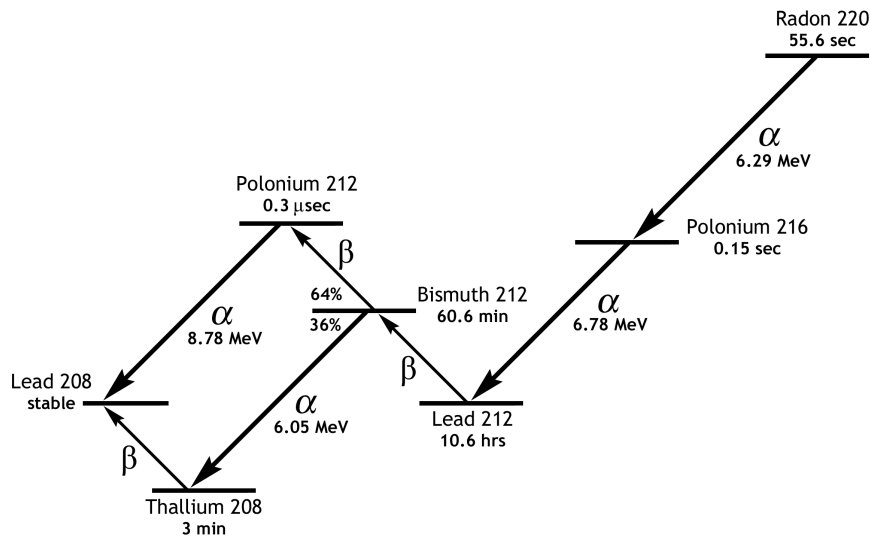

4.1.1 Radon-222 (Radon)

Every nucleus of radon-222 eventually decays through the sequence polonium-218, lead-214, bismuth-214, polonium-214, and lead-210. With each transformation along this path the nucleus emits characteristic radiations: alpha particles, beta particles, or gamma rays, or combinations of these. The RAD8 was designed to detect alpha particles only, so we will emphasize alpha radiation.

Radon-222 is an inert gaseous alpha-emitter that does not stick to or react with any materials. It has a half-life of 3.82 days. A particular radon nucleus may decay at any time, but it is most likely to decay between now and 8 days (two half-lives) from now. When the radon nucleus decays, it releases an alpha particle with 5.49 MeV of energy, and the nucleus transforms to polonium-218. The polonium nucleus can never go back to radon again. Polonium atoms are metals and tend to stick to surfaces they come in contact with, e.g., a dust particle in the air, or a wall, or the inside of your lung!

Polonium-218 nuclei have a short half-life, only 3.05 minutes, which means that most of them will decay within 6 minutes of their formation. The average polonium-218 nucleus lives for only 4.40 minutes before it decays (1.443 times the half-life gives the mean life). Like radon, polonium-218 emits an alpha particle when it decays, but with an energy of 6.00 MeV rather than radon's 5.49 MeV.

When polonium-218 decays, it transforms to lead-214, also a radioactive solid. But lead-214 has a half-life of 26.8 minutes, and it emits beta radiation rather than alpha radiation. When lead-214 decays, it becomes bismuth-214, also a radioactive solid and a beta emitter. Bismuth-214 has a half-life of 19.8 minutes, and transforms to polonium-214 when it decays.

Polonium-214 is a bit different. It has a half-life of only 164 microseconds (0.000164 seconds) and it emits a 7.69 MeV alpha particle when it decays. When polonium-214 decays, it becomes lead-210, which has a half-life of 22.3 years. This means that an average lead-210 nucleus takes 1.443 times 22.3 years, or 32.2 years, to decay. Because of its long half-life, we usually ignore lead-210 as a factor in radon measurement, though it adversely affects the background of some instruments (not the RAD8).

Lead-210 eventually undergoes beta decay to Bismuth-210 which quickly (5 days half-life) undergoes a further beta decay to polonium-210. Polonium-210 has a half-life of 138 days and decays with a 5.30 MeV alpha particle to Lead-206, which is effectively stable. The 5.30 MeV alpha particle from polonium-210 creates unwanted background in most radon monitors, but not in the RAD8.

4.1.2 Radon-220 (Thoron)

Similarly to radon-222, every radon-220 (thoron) nucleus eventually decays through a sequence of 5 transformations to Lead-208. The main distinction is the very different half lives involved.

Thoron has a half-life of only 55.6 seconds. It emits a 6.29 MeV alpha particle and transforms to polonium-216, which in turn has only a 0.15 second half-life before emitting a 6.78 MeV alpha particle and transforming to lead-212.

Lead-212 hangs around for a long time, with a half-life of 10.6 hours. It transforms by beta decay to bismuth-212, which, in turn, has a half-life of 60.6 min.

Bismuth-212 has a 2:1 split, with two thirds transforming by beta decay to polonium-212 and one third transforming by 6.05 MeV alpha decay to thallium-208. The polonium-212 decays immediately to lead-208, emitting an 8.78 MeV alpha particle in the process, while the thallium-208, with a half-life of 3 min, undergoes a beta decay to the same destination, lead-208.

4.2 Continuous Monitors

There are several types of continuous radon monitors on the market. Nearly all of these are designed to detect alpha radiation, but not beta or gamma radiation. Why? Because it is very difficult to build a portable detector of beta or gamma radiation that has both low background and high sensitivity.

Three types of alpha particle detectors are presently used in electronic radon monitors:

1. Solid state alpha detectors
2. Scintillation cells or "Lucas cells"
3. Ion chambers

Each of these types has advantages and disadvantages relative to the others.

The DurrIDGE RAD8 uses a solid state alpha detector. One important advantage of this detector is its ruggedness. Another advantage is the ability to electronically determine the energy of each alpha particle. This makes it possible to tell exactly which isotope (polonium-218, polonium-214, etc.) produced the radiation, so that you can immediately distinguish old radon from new radon, radon from thoron, and signal from noise. This technique, known as alpha spectrometry, is a tremendous advantage in many applications, including sniffing and grab-sampling. Very few instruments other than the RAD8 are able to do this.

A distinction should be made between true, real-time continuous monitors, and other instruments and devices. With a continuous monitor, you are able to observe the variation of radon level during the period of the measurement. This can sometimes show big swings in radon concentration and may allow you to infer the presence of processes influencing the level. For good data, it is important that there be sufficient counts to provide statistically precise readings. Devices which give just a single, average reading, or whose precision is inadequate except after a long measurement time, are not, in this sense, continuous monitors.

Another important parameter is background. This is the reading given by the instrument when there is no radon in the air sample. For low level continuous monitoring, it is necessary that the background be extremely low and stable. Because of the high quality alpha detector, and unique, real-time spectral analysis, the RAD8 background is vanishingly small, and is immune to the buildup of lead-210, which plagues other instruments.

4.3 Radon Sniffers

Sniffing means taking quick, spot readings. Thus you can get a rough idea of the radon level, without waiting for a full, 48-hour, EPA protocol test. The technique is often used to locate radon entry points in a building.

Any fast-response, continuous radon monitor, with a pump, can be used for sniffing. However, there are some factors to consider, one of which is the rate of recovery after exposure to high radon levels. When the sniffer finds a radon entry point, the whole radon decay chain builds up inside the instrument, and the various daughters become well populated. If the sniffer now moves to a low level region, it will take many hours for the lead/bismuth/polonium-214 daughters to decay away. In the RAD8 this doesn't matter, because in Rapid analysis mode it looks only at the polonium-218 decays, and ignores the polonium-214 decays left over from previous sniffs. The polonium-218 has a three-minute half-life, so the RAD8, sniffing for radon, has a 15-minute response time to both sudden increases and sudden decreases in level.

Unique to the RAD8 is the ability to simultaneously sniff for thoron. The thoron daughter, polonium-216, has a 150 ms half-life, so the instrument response is virtually instantaneous. The only delay is the time required to pump the air sample into the measurement chamber, which is about 45 seconds.

Another factor when sniffing with other instruments is the vulnerability to lead-210 buildup. Only with the RAD8 can you continue to sample high levels, without having to worry about increasing the background.

4.4 Working Level

Radon concentrations are determined by measuring the radioactivity of the radon or by measuring the radioactivity of radon decay products in equilibrium with the parent radon. Instruments that measure pre-existing airborne radon decay products are called "working level" monitors. Working level monitors sample air through a fine filter and then analyze the filter for radioactivity. The radon progeny are metals and they stick to the filter, where their subsequent decays are counted by a detector. Radon-222, an inert gas, passes through the filter, so it is not counted in such an instrument. Therefore, a working level instrument measures the radon progeny concentration (polonium-218, etc.), in the air, but not the radon gas concentration.

The RAD8, on the other hand, measures radon (and thoron) gas concentration. Pre-existing airborne radon progeny do not have any effect on the measurement. In short, the RAD8 does not measure radon daughter concentrations (working levels), only radon (and thoron) gas concentrations.



Do not confuse the RAD8's spectrum with that of a working level instrument. The alpha peaks may appear the same, but the RAD8 is really measuring radon gas, not the working level.

4.5 RAD8 Solid-State Detector

The RAD8's internal measurement chamber contains a solid-state alpha detector, which detects the energy of alpha particles from the decay of radon and thoron progeny produced inside the measurement chamber. In Rapid Analysis Mode, the RAD8 uses only the polonium-218 signal to determine radon concentration, and the polonium-216 signal to determine thoron concentration, ignoring the subsequent and longer-lived radon daughters. In this way, the RAD8 achieves fast response to changes in radon concentration, and fast recovery from high concentrations. In Precise Analysis mode, the polonium-214 counts are also included, increasing the sensitivity at the expense of response time, which is increased from 15 minutes to 2.5 hours.

4.5.1 RAD8 Calibration and Data Correction

The RAD8 depends on calibration to determine the radon and thoron concentrations it measures. Built into the RAD8 firmware are four sensitivities:

1. Rapid analysis mode radon sensitivity, counting only polonium-218 for the fastest response.
2. Precise analysis mode radon sensitivity, counting both polonium-218 and polonium-214 decays for the highest precision.
3. Thoron sensitivity for Standard pump mode, counting polonium-216 decays for thoron.
4. Thoron sensitivity for ON pump mode, counting polonium-216 decays for thoron with increased sensitivity to thoron.

In calibration, the RAD8 is exposed to a known concentration of radon (or thoron) and the count rates are measured. Your radon calibration certificate gives the two radon sensitivities.

For thoron calibration (optional), a separate calibration memo gives the calibrated thoron sensitivities for Standard and ON pump modes. The RAD8 automatically applies the appropriate sensitivity when calculating the reported thoron activity concentration.

In addition to the bare count rates in the three windows, there are various corrections and calculations that may be applied to calculate more precise radon and thoron concentrations. Some of these corrections are made automatically by the RAD8 itself. Others are optionally applied using DurrIDGE's Capture software, after the data has been downloaded onto your computer.

4.6 RAD8 Spectrum

The RAD8 spectrum is a scale of alpha energies from 0 to 10 MeV. Of particular interest are the radon and thoron daughters that produce alpha particles in the range of 6 to 9 MeV.

When the radon and thoron daughters inside the RAD8 decay, they emit alpha particles of characteristic energy.

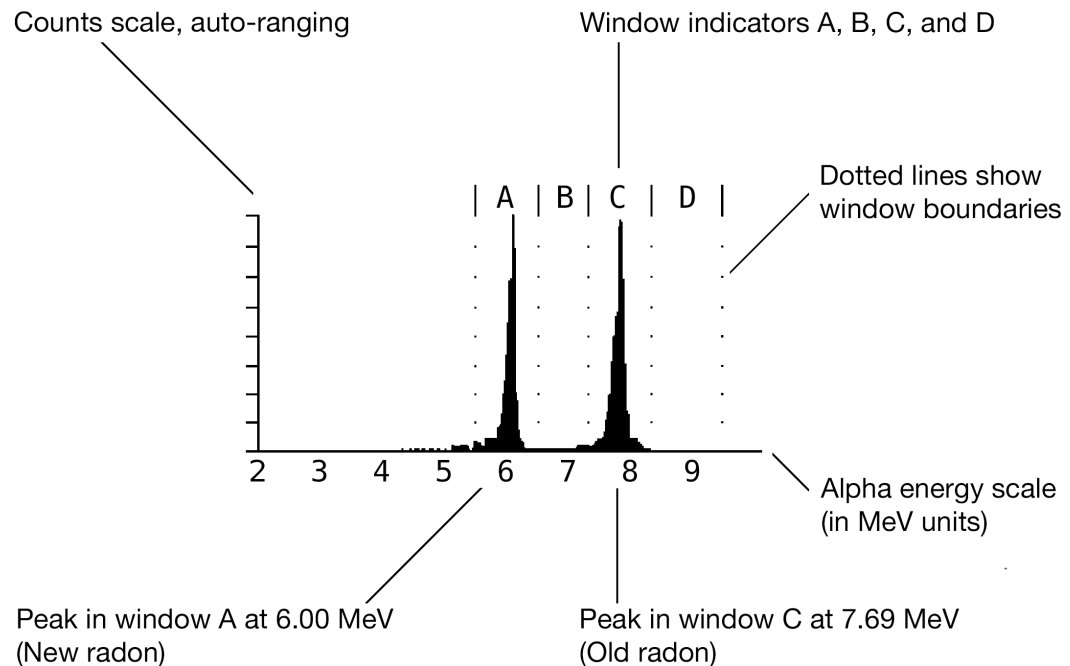

RAD8 Alpha Energy Spectrum

A combination of different alpha emitters appears on the spectrum as a series of different peaks. For example, a combination of equal amounts of polonium-218 and polonium-214 (as would occur in the case of secular equilibrium between radon and its short-lived progeny) appears as twin alpha peaks. One peak (polonium-218) is centered at 6.00 MeV, while the other (polonium-214) is centered at 7.69 MeV.

The first example spectrum, shown in Section 4.12.1, is the characteristic signature of radon at equilibrium with its alpha emitting progeny. We would expect to see a spectrum like this after several hours at a constant radon level.

4.7 Windows

The RAD8 groups the spectrum's numerous channels into several "windows" or energy ranges. In summary, Window A covers the energy range of 5.40 to 6.40 MeV, and this includes the 6.00 MeV alpha particle from polonium-218, representing newly decayed radon. Likewise, Window B represents new Thoron. Window C represents "old radon" which decayed less recently. Similarly, Window D represents old thoron. The Spectrum view clearly marks Window A, B, C, and D with dotted lines, as shown in the figure in Section 4.6. The RAD8 also includes Windows E, F, G, and H, which may be collectively referred to as Window O (for "other").

Here is a more detailed explanation of each window's function:

- A. Radon Rapid Analysis Mode counts. The total counts of alpha particles from the 3-minute, 6.00 MeV, polonium-218 decay.
- B. Thoron 1 Window. The total counts in the region of the 0.15 second, 6.78 MeV decay of polonium-216. This window lies between Window A and C of the radon groups and may have some counts from spill-over from the C window (see Section 4.5.1).
- C. Radon Precise Analysis Mode (polonium-214) counts. The total counts of the 7.69 MeV alpha particles from the decay of the great-great granddaughter of radon, which has an effective half-life of nearly an hour.
- D. Thoron 2 Window. The total counts in the region of the 8.78 MeV decay of polonium-212, which has a half-life of about 10 hours. Used only in the onboard correction of the Window A counts for bismuth-212, as shown in Section 4.5.1 c).
- O. Composite window for "Others". The RAD8 groups Windows E, F, G, and H together to form the composite Window O. This window catches all the counts that did not go into the major Windows A, B, C, and D. If Window O consistently receives more than 30% of the total counts, you should inspect the spectrum for signs of trouble.

4.8 Isotope Equilibrium

Take a RAD8 that is completely clean, with no radon or radon progeny inside. What does the detector see? Close to nothing. Less than one alpha count per hour, due to trace amounts of radium in the materials of the instrument's construction. That is the instrument's intrinsic background. It is ignored by most people as of no consequence. Intrinsic background adds approximately 0.004 pCi/L to a typical measurement, far below the (low) radon concentration of outdoor air, which is usually 0.10 to 1.00 pCi/L.

Now introduce some radon into the RAD8. What do you see? At first, nothing. But within a few minutes, you begin to get counts in Window A. The RAD8 may produce an audible chirp with each count. This is polonium-218, a result of the decay of radon-222 within the RAD8 sample chamber.

For the first 5 minutes or so, the count rate increases, then begins to approach a steady level. After about 10 minutes, the polonium-218 daughter has reached close to equilibrium with the radon-222 parent. Equilibrium is when the activity of the daughter

stabilizes, neither increasing or decreasing. At this point, nearly all of the counts land in Window A, and you see a single peak in the spectrum printout.

But the total count rate is still increasing, albeit more slowly. You begin to see counts appear in Window C. Just a few, but more and more of them over the course of the next hour or two. After 3 hours or so, we achieve full equilibrium, in which the activities of all the progeny stabilize. Now the spectrum shows the characteristic twin peaks: polonium-218 in Window A and polonium-214 in Window C. The peaks are of almost identical size.

Now flush the RAD8 with fresh, radon-free air. The count rate in Window A immediately begins to drop, just as fast as it rose when you first put the radon in. Without radon inside the RAD8, there is no source to replace the polonium-218 that decays. So the polonium-218 disappears with its characteristic half-life of 3.05 minutes.

After 3.05 minutes, the count rate in Window A is half of what it was before. After 6.10 minutes, the count rate is half of that, or one-quarter of what it was before. After 10 minutes, there are hardly any counts at all in Window A. However this is not the case for Window C. The spectrum still shows a single strong peak in Window C.

The peak in Window C takes hours to disappear. After half an hour, the count rate in Window C has not even halved. Polonium-214 may have a very short half-life, but its grandparent and parent, lead-214 and bismuth-214, respectively, take longer to decay: one has a half-life of 26.8 minutes, and the other has a half-life of 19.8 minutes. These decays are sequential, prolonging the process.

After you completely remove the radon, it may be 3 or more hours before the counts really die down in Window C. We call Window C the "old radon" window, since it represents counts from radon that was present in the RAD8 an hour or more before.

The effect of time in Windows B and D is comparable, but much more pronounced. There is no delay in the RAD8 to polonium-216, so the count rate in Window B is always in equilibrium with the thoron gas in the measurement chamber. In contrast, there is a 10-hour half-life in the decay chain down to polonium-212, so it takes days for Window D to reach equilibrium. Window D is therefore not used by the RAD8 in the calculation of its reported thoron activity concentration.

4.9 Analysis Modes: Rapid, Precise, and Automatic

Rapid Analysis Mode means that the RAD8 calculates the radon concentration from the data in Window A only. It ignores Window C. Now the instrument responds to changes almost instantaneously. Hit a "hot spot?" No problem. In Rapid Analysis Mode, you can purge the sample chamber and, in 10 minutes, you're ready to measure low levels again. You can move from point to point in minutes, looking for radon entry points in foundation cracks or test holes.

For continuous monitoring in one location over many hours, Precise Analysis Mode is the way to go. Precise Analysis Mode means that the RAD8 uses both radon peaks, A and C, to calculate concentration. With double the count rate, you increase the precision of the measurement. In indoor environments, the radon concentrations rarely fluctuate quickly enough to justify using Rapid Analysis Mode for continuous monitoring.

The best of both worlds is provided by the default Auto mode. Here, the RAD8 starts a test in Rapid Analysis Mode, and then, after three hours, switches automatically to Precise Analysis Mode. In this way, the first few cycles give readings without any bias from either "old" radon progeny left on the detector, or the slow build-up to reach equilibrium in Window C, while the rest of the readings benefit from the higher precision given by twice the number of counts in each cycle.

For real-time monitoring, you are always better off to leave the mode in Auto. The RAD8 gets up to speed quickly, and is not influenced by old measurements. The final average of the test is therefore more accurate and more reliable.

Durridge's Capture software can read a RAD8 data file and switch between Rapid and Precise analysis modes at the click of a button.

Therefore, if after looking at data taken in Precise Analysis Mode, there is what appears to be a rapid change in radon concentration, changing to Rapid Analysis Mode presentation in Capture will permit another look at the changes with better time resolution.

4.10 Background

"Background" in a radon detector refers to spurious counts that occur even in the absence of radon in the sample volume. Background can arise from the properties of the instrument or its components, other forms of radiation in the instrument's environment, or contamination of the instrument.

The RAD8's design makes it much less susceptible to background counts than other radon monitors, but one should still be aware of background in the RAD8 to avoid mistakes. The following list gives possible sources of background in the RAD8:

4.10.1 Short-lived Radon and Thoron Progeny

These are by far the most important components to background in the RAD8. Radon and thoron progeny that normally build up on the RAD8's detector continue to produce alpha counts for some time after the radon and thoron gasses have been removed from the instrument. These lingering progeny can greatly confuse the result when you try to measure a low radon sample immediately after a high radon sample.

Many radon detectors require that you wait for the short-lived progeny to decay away (about three hours) before counting another sample. With the RAD8 however you can go from high to low concentrations in a matter of minutes by switching to Rapid Analysis Mode, since the instrument distinguishes the different alpha-emitting progeny by their alpha energy. The resulting reported radon concentration responds with a 3.05-minute half-life. Thus, 10 minutes after the radon has been removed from the instrument, the background will have been reduced by more than 90%, and you can count a new sample.

Thoron progeny are worse behaved than radon progeny. One thoron progeny species, lead-212, has a half-life of 10.6 hours, which means if you sample large concentrations of thoron you may have to wait one to two days before using your radon instrument again to get accurate radon measurements. The RAD8's ability to distinguish daughters by their alpha energy almost always makes it possible to continue working, unlike other detectors that lack the RAD8's sophisticated species discrimination.

4.10.2 Adsorbed Radon Gas

Radon atoms can adsorb on or absorb into internal surfaces of the RAD8, on the inside of tubing or on desiccant granules. This radon can stay behind after you purge the instrument, then desorb (or out-gas) from these surfaces and enter the measurement chamber volume. This effect is ordinarily negligible since only a small fraction of the radon ever becomes adsorbed. But at very high radon concentrations (over 1000 pCi/L), even a small fraction can be significant, and you can expect to see some lingering radon after purging the instrument.

The best solution is to purge for 10 minutes every few hours until the count rate goes down. Even in the worst possible case, the radon must decay with a 3.82 day half-life, so the background will return to its original (very low) level within, at most, a few weeks.

4.10.3 Intrinsic Background

Due to very low concentrations of alpha emitting contaminants in the materials of the RAD8's construction, you can expect to get approximately one count every five hours (0.003 cpm) without any radon present. This count rate, corresponding to about 0.004 pCi/L, is low enough to neglect when doing routine indoor radon work. But for very low-leveled outdoor radon levels, or special clean room applications, this background may be significant. With painstaking technique, and long-term monitoring, it can be measured. Very low level readings can then be corrected for background, bringing the detection threshold of the instrument down below 0.004 pCi/L.

4.10.4 Long-lived Radon Daughters

After many years of use at elevated radon levels, your RAD8's detector will accumulate lead-210, a radionuclide with a 22-year half-life. Though lead-210 is itself a beta emitter, one of its daughters is polonium-210, which produces a 5.3 MeV alpha particle. The RAD8 is able to distinguish this isotope by its energy, and exclude it from all calculations. Lead-210 buildup does not contribute to background in the RAD8, even after years of use.

4.10.5 Contamination by Radon, or Thoron, Producing Solids

If radon- or thoron-producing solids, such as radium-226 or thorium-228, become trapped in inlet hoses or filters, they may emanate radon or thoron gas that will be carried through the filters and into the instrument. Certain dusty soils may contain enough of these isotopes to make this scenario possible. Usually, replacing the inlet filter is enough to remove the contamination. However, if you suspect that a source of radon or thoron has made its way past the filter and into the RAD8, please call DurrIDGE. We would like to discuss your experience with you and help you solve your problem.

4.10.6 Other Alpha Emitters

As long as you filter the incoming air stream, there is little or no possibility for contamination of the instrument with other alpha emitters. Virtually all solids will be stopped by the inlet filter. The only naturally-occurring alpha-emitting gas other than radon and thoron is radon-219, or "actinon." Actinon, which has a very short half-life (less than four seconds), results from the decay of naturally-occurring uranium-235. But since uranium-235 is so much less abundant than uranium-238 (the ancestor of radon-222), we do not expect to ever see actinon in significant quantities apart from alongside much larger quantities of radon.

4.10.7 Beta and Gamma Emitters

The RAD8's detector is almost completely insensitive to beta or gamma radiation, so there will be no interference from beta-emitting gasses or from ambient gamma radiation. Typical environmental levels of beta and gamma emitters have absolutely no effect on the RAD8.

4.11 Precision and Accuracy

4.11.1 Dry operation

"Precision" means exactness of measurement with regard to reliability, consistency and repeatability. "Accuracy" means exactness of measurement with regard to conformity to a measurement standard.

As long as the operator follows consistent procedures, counting statistics will dominate the RAD8's precision. The most important factor in RAD8 accuracy is calibration.

DurrIDGE calibrates all instruments to a set of four "master" instruments with a calibration precision of 1% or better. The master instruments have been calibrated by way of inter-comparison with secondary standard radon chambers designed by the U.S. EPA. We estimate the accuracy of the master instrument to be within 4%, based on inter-comparison results. We estimate the overall calibration accuracy of your RAD8 to be better than 5%.

The table on the following page summarizes the precision of the RAD8 according to the contribution of counting statistics. Counting statistics depend on sensitivity (calibration factor) and background count rate. The RAD8's intrinsic, or "fixed," background count rate is so low as to be a negligible contributor to precision, for the range of radon concentrations covered by the table. The uncertainty values reported by the RAD8 are estimates of precision based on counting statistics alone, and are two-sigma values, as are the values in the table below.

	1 pCi/L	4 pCi/L	20 pCi/L	100 pCi/L
1 hour	0.29 (29%)	0.14 (14%)	0.06 (6.4%)	0.03 (2.8%)
2 hours	0.20 (20%)	0.10 (10%)	0.05 (4.5%)	0.02 (2.0%)
6 hours	0.12 (12%)	0.06 (5.8%)	0.03 (2.6%)	0.01 (1.2%)
24 hours	0.06 (5.8%)	0.03 (2.9%)	0.01 (1.3%)	0.01 (0.6%)
48 hours	0.04 (4.1%)	0.02 (2.1%)	0.01 (0.9%)	0.004 (0.41%)
72 hours	0.03 (3.4%)	0.02 (1.7%)	0.01 (0.8%)	0.003 (0.034%)

Table: 3.11 Typical RAD8 precision based on counting statistics only.

Precise Analysis Mode with sensitivity 0.820 cpm/(pCi/L). Table values are two-sigma (or 95% confidence interval) relative uncertainties.

4.11.2 Humidity Correction

Much of the superior functionality of the RAD8 is a result of the high-precision real-time spectral analysis that it performs. The high resolution of the energy spectrum is obtained by precipitating the radon daughters, formed by the decay of radon, right onto the active surface of the alpha detector. The combination of a precipitation process and the physical attributes of the RAD8 measurement chamber means that humidity inside the measurement chamber will affect the sensitivity of the instrument. The effect is a function of the absolute humidity.

At normal room temperature and with good desiccant in the air sample path, the humidity in the measurement chamber at the start of a measurement will quickly be brought down below 10% RH and will eventually settle below 6%. Should the desiccant expire and/or should the operating temperature rise well above normal room temperature, the absolute humidity may become significant and a humidity correction may be required to compensate for the drop in sensitivity.

4.11.3 Concentration Uncertainties

Obtaining accurate readings of low radon concentrations requires long Cycle Times, because when there are zero or very few counts within a given timeframe, the statistical uncertainty is proportionately high. Radioactive decays obey Poisson statistics, in which the standard deviation (one-sigma) is the square root of the count. However, at very low counts Poisson statistics underestimates the uncertainty. To compensate, the RAD8 defines sigma as $1 + \text{SQR}(N+1)$, where N is the number of counts. Thus when there are no counts, instead of reporting a nonsensical zero uncertainty, the RAD8 reports an uncertainty value based on a two-sigma, 95% confidence interval, equivalent to ± 4 counts for a cycle in which zero counts were recorded.

In Precise Analysis Mode, an average count rate of 0.2 cpm (i.e. one count in five minutes) would indicate a radon concentration of about 9 Bq/m³. In a five-minute run, sigma would be $1 + \text{SQR}(N + 1)$ or 2.4 counts, and the reported two-sigma value would be 4.8 counts. Thus after 5 minutes, the uncertainty would be reported as 1 cpm, or ± 45 Bq/m³.

Large uncertainty values are often the product of the fact that it is impossible to measure low radon concentrations quickly. Greater certainty can be achieved by increasing the Cycle Time and/or by averaging multiple Cycles. In Rapid Analysis Mode, polonium-218 (which has a 3.05 min half-life) takes around 12 minutes to reach equilibrium with the radon concentration in the RAD8 chamber.

Occasionally, a concentration uncertainty greater than the base value may be reported, e.g. 0.00 ± 36.1 Bq/m³. Such values are typical for Cycles containing zero counts. This should not be taken to suggest that a negative concentration may have occurred. The RAD8 does not report different positive and negative uncertainties, and it is expected that the user will recognize that the negative uncertainty can never be greater than the base value of the reading.

4.12 Spectrum Examples

4.12.1 Operational Radon Spectra

A. Radon in full equilibrium

After more than three hours at a constant radon level. The count rate in Window C is about the same as in Window A.

A	6.00 MeV	Po218
C	7.69 MeV	Po214

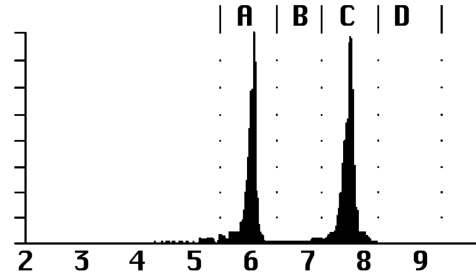

B. New radon

The RAD8 spectrum after less than one hour of exposure to radon. The peak in Window C is just beginning to grow in, but its count rate is still much less than in Window A.

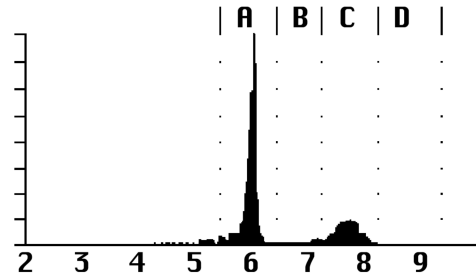

C. Old radon

The RAD8 spectrum after purging the instrument with radon-free air for more than 10 minutes, following exposure to radon.

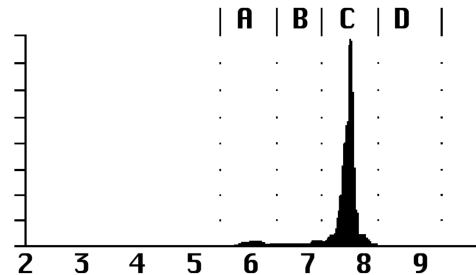

4.12.2 Thoron Spectra

A. New thoron

The RAD8 spectrum while continuously sampling thoron-laden air

B 6.78 MeV Po216

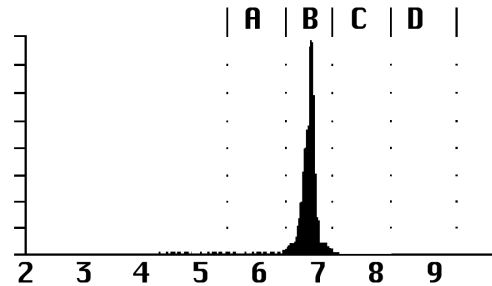

B. Thoron in equilibrium

The spectrum after continuously sampling thoron-laden air for more than 12 hours. The count rate in Window A should be about half the count rate in Window D

A 6.05 MeV Bi212
 B 6.78 MeV Po216
 D 8.78 MeV Po212

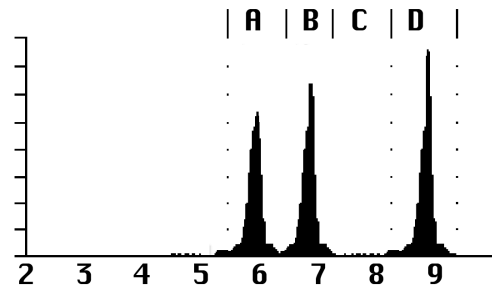

C. Old thoron

The spectrum after discontinuing a lengthy sampling of thoron laden air. The thoron peak, B, disappears immediately. The remaining two peaks decay together with a 10.6 hour half-life. The count rate in Window A should be about half the count rate in Window D.

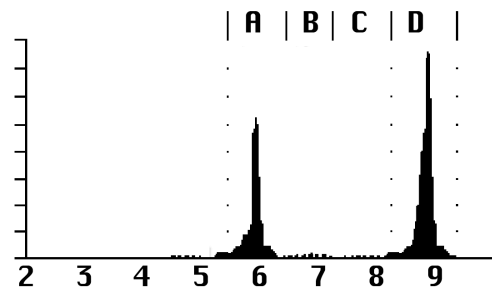

4.12.3 Combination Spectra

Radon and thoron spectra can add together to form combination spectra. Peaks in Window B and/or D come from thoron, while a peak in Window C comes from radon. The peak in Window A is usually entirely from radon, but if there is a peak in Window D, then there will be a contribution of 0.561 times the D count rate to the peak in Window A (due to the bismuth-212 branching ratio discussed in Section 4.8).

The RAD8 takes this into account, and always adjusts the Window A count rate to correct for the bismuth-212 count, before calculating the radon concentration. The spectra below have comparable amounts of radon and thoron, but you will usually see one of the two much stronger than the other.

A. New radon with new thoron.

Peaks grow in Window A, representing new radon, and Window B, representing new thoron.

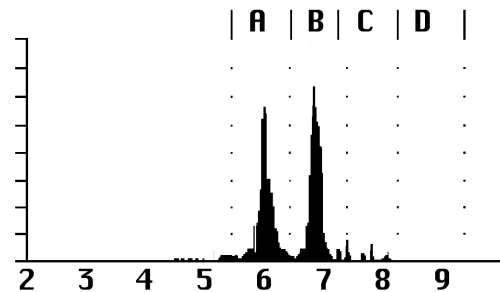

B. Equilibrium radon with new thoron

Peaks grow in Window A and Window C, representing new radon and old radon, respectively, plus Window B, representing new thoron.

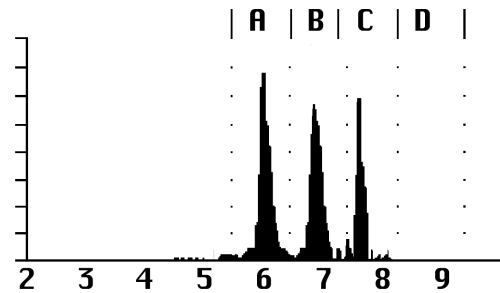

C. Equilibrium radon with equilibrium thoron.

The count rate in Window A is roughly the rate of Window C plus half the rate of Window D.

A	6.00 MeV	Po218
	+6.05 MeV	Bi212
B	6.78 MeV	Po216
C	7.69 MeV	Po214
D	8.78 MeV	Po212

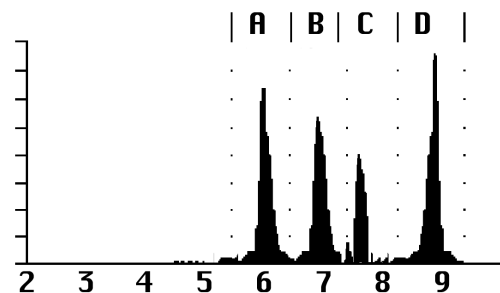

D. Equilibrium radon with old thoron

The count rate of Window A is roughly the rate of Window C plus half the rate of Window D.

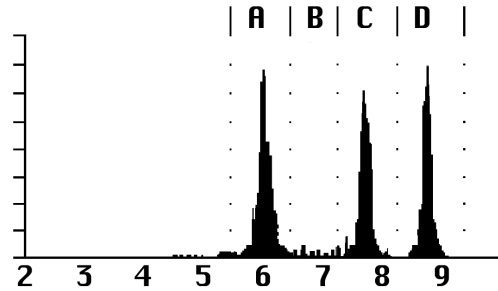

E. Old radon with old thoron.

The count rate in Window A is no more than about half the count rate of Window D.

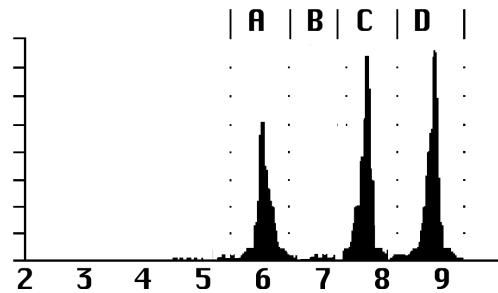

F. New radon with old thoron.

Looks like an old thoron spectrum, but the count rate of Window A is significantly more than half the count rate of Window D.

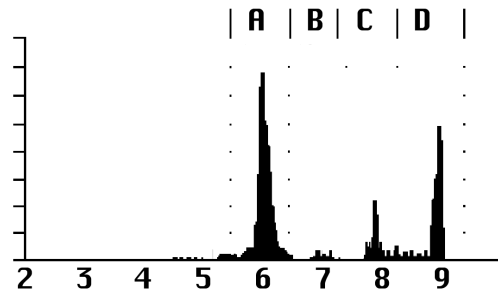

G. New thoron with old radon.

Peaks form in Window B, representing new thoron, plus Window C, representing old radon.

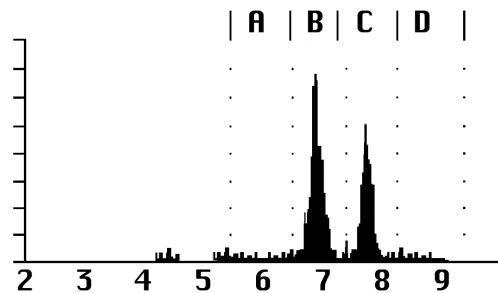

4.12.4 Pathological Spectra

If any of the following occur, and an external cause is not identified, the RAD8 may be malfunctioning and it may be necessary to contact Durrige for service.

A. No counts.

Try a longer counting time. If there is not a single count in an hour, that is a clear indication of an instrument malfunction.

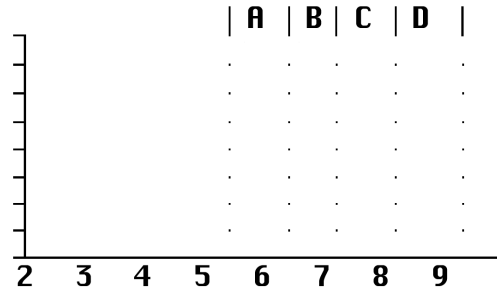

B. Few counts.

Normal for low radon levels and short counting times. Abnormally low counts could be caused by disruption of the air flow, or by malfunction in the high voltage circuit.

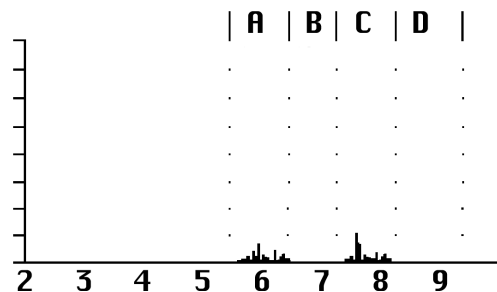

C. Lead-210/polonium-210.

A persistent peak at 5.3 MeV will develop from many years of regular use, or from sustained exposure to very high radon levels. It results from the buildup of lead-210 on the detector surface. Lead-210 has a 22 year half-life. It is not a problem for the RAD8 because the peak is outside Window A, and thus does not contribute to the background.

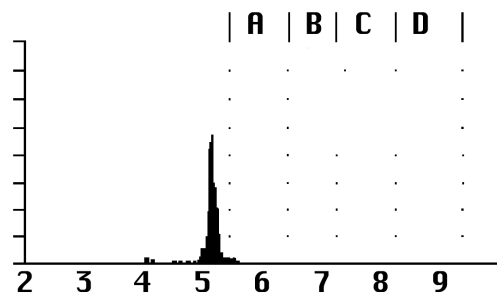

D. Wide alpha peaks.

Typically caused by electronic noise in the system. May be associated with vibration or high operating temperature.

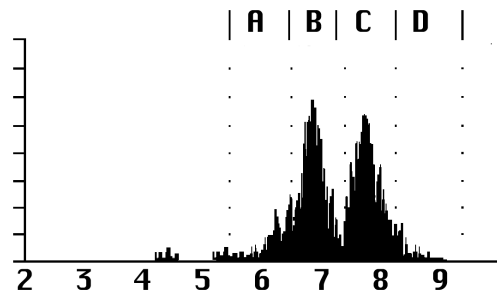

E. Smear spectrum.

Alpha peaks cannot be discerned by the eye.
Severe electronic noise.

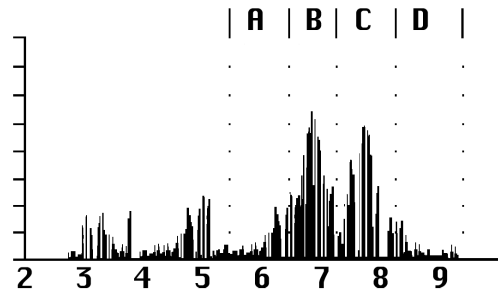

F. Low energy noise.

Independent of radon or thoron, such electronic noise may be intermittent or be associated with vibration.

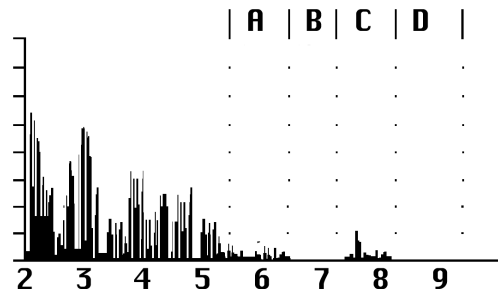

G. Shifted peaks.

Peaks appear normal, but are shifted in position.
Shows a malfunction of the RAD8, which should be returned to Durrige for service without delay.

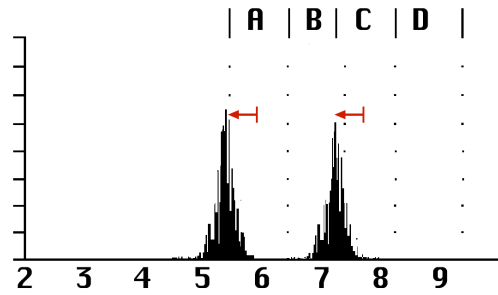

H. Heavy tails on alpha peaks.

The peaks are narrow, but have unusually thick tails.
This may be caused by electronic noise, or by malfunction of the alpha detector.

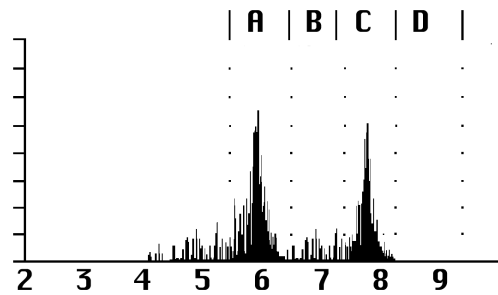

5 USING THE RAD8: MEASURING RADON AND THORON IN AIR

5.1 Introduction

The different ways of using the RAD8 may be arranged in six categories:

- (a) Continuous monitoring of radon in air
- (b) Sniffing for radon and/or thoron
- (c) Testing air grab samples
- (d) Measuring radon in water
- (e) Testing soil gas
- (f) Measuring radon and thoron emissions from objects and surfaces.

While all six are discussed below, it is primarily categories (a) and (d) that require standard operating procedures. The other applications tend to be more interactive, and individuals will develop protocols which work best for them. This section focuses on using the RAD8 to measure radon and thoron in air, without the use of special hardware accessories. Section 5 introduces applications involving the optional RAD AQUA, RAD H₂O, and other DurrIDGE accessories.

5.2 Continuous Monitoring

5.2.1 Preparation

The RAD8 battery should be fully charged so that, even if there is a power cut, the test will be completed. Similarly, there should be more than sufficient active (blue) desiccant in the Laboratory Drying Unit.

For an EPA protocol test, the house should be fully closed from 12 hours before the start of the test. This means that ALL doors and windows should be shut tight. No air exchange system, or ventilation fans, may be running.

In winter it is not difficult to satisfy this requirement. Continued operation of the furnace is permitted. Closed house conditions are usually maintained anyway, to save heating costs. Doors may be opened momentarily, for access, but should otherwise remain closed during the test.

In summer it may be impossible to satisfy the requirement, without the residents moving out for the duration of the test. If doors and windows are left open, it can nullify the test, except that if there is a radon problem under these conditions, then there will be a greater problem under closed house conditions.

Air conditioning often includes some fresh air ventilation, which dilutes the radon. Even if there is no ventilation, the cold air in the house will want to sink, increasing pressure in the basement, and thus reducing any flow of soil gas into the house. So air conditioning in the summer will tend to lower the radon level in the house.

5.2.2 Purging

For the RAD8 to be all set to go, ready to start a test, it should be purged for at least five minutes beforehand.

Locate a Laboratory Drying Unit and a length of tubing to connect it to the RAD8. The tubing will have a sleeved end which attaches to the Laboratory Drying Unit. The narrower end of the tubing contains a filter assembly, and connects to the RAD8's Sample In port. Remove the plastic caps from the Laboratory Drying Unit's tubing ports, and push the sleeved end of the tubing onto the drying unit port farthest from the screw cap. The end of the tube with the filter will pop in to the RAD8 Sample In port with an audible click. Make sure that the pump tubing bridge is in place between the Pump Out and Detector In ports on the front panel, and that the Sample Out outlet port is populated (and, hence, open).

Power on the RAD8, and from the Main Menu screen choose **Start Test**. The Select Protocol screen will appear. Choose the **Purge** option. Once purging has begun the RAD8 pump will start. The Purge screen will display the elapsed time and the current relative humidity. Leave the unit purging for five minutes or longer. Then choose **Stop Purge**.

5.2.3 Test Location

In general, the test should be conducted in the "lowest area in the house that is used, or could be adapted for use, as a living area". This would include a full-height basement, but not a crawl space.

Place the RAD8 near the center of the room, about 3 - 4 feet above the floor. Avoid walls, vents, fireplaces, windows, draft, and direct sunlight.

Where possible, connect DC power to the RAD8, to conserve and recharge its battery.

The air intake will be the connector of the Laboratory Drying Unit without any tubing attached (nearest the end with the screw cap). A tube is connected to this end of the drying unit, to draw air from another location. Make sure the air intake is at least 30 inches (75 cm) above the floor, and away from the walls.

Once set up in location, let the RAD8 continue to purge as needed until ready to start the test.

5.2.4 Test Protocol

In any location there is often a diurnal variation of radon level. It is therefore preferable that the test period be an exact number of whole days. (The EPA protocols require an average taken over at least two days.) The RAD8 offers preset protocols for 1-Day and 2-Day tests. The 1-Day Protocol involves 48 30-minute Cycles, and the 2-Day Protocol involves 48 60-minute Cycles. Each Cycle produces a data point with a particular radon concentration, making it possible to visualize any fluctuations in the radon concentration over time. The temporal resolution of the data points is the Cycle Time, and it is an attribute of the selected Protocol, but this setting can be overridden, either before starting the test, or after the fact once the data has been imported in DurrIDGE's Capture software.

Your Cycle Time and Cycle Count preferences may also be saved in a custom RAD8 protocol. You may, for instance, prefer to conduct 3-day tests, perhaps using 24 cycles, each 3 hours long. Longer cycles produce more precise results with lower statistical uncertainty. However, Cycles that are excessively long may mask any patterns of change caused by diurnal variation or other factors, and long Cycles can also make it hard to pinpoint the exact time at which a step change in radon concentration occurs.

For a 24-hour or 48-hour test, choose the 1-Day or 2-Day protocol as desired. You may also configure the RAD8's printing settings and audio settings at this time using the System Settings. See Section 2.6 for details.

For very long term monitoring, use the Continuous Test protocol. This sets the RAD8 to continue running indefinitely, with 2-hour cycles. The RAD8's ample onboard storage can record data for years before filling up, so there is typically no need to clear the memory, even after very long tests.

When the Laboratory Drying Unit is used to dry the sampled air, the desiccant will have to be replaced every 7 to 14 days, depending on the humidity. The RAD8 needs external power for indefinite operation, but it can continue to record data during a power outage until the battery is depleted.

For other measurement periods, it will be necessary to set the parameters yourself. The Cycle Time and the duration of the total measurement may be set using the Manual Configuration option, which appears at the top of the Select Test Protocol Screen. In almost every case, for continuous monitoring, the Analysis Mode should be set to Automatic, and the Pump Mode should be set to Standard.

After three hours of operation the RAD8 will switch from Rapid Analysis Mode to Precise Analysis Mode, meaning that the reported radon concentration will begin to account for the Window C counts. These counts come from the decay of polonium-214 atoms, which are themselves the product of radon decays that occurred inside the RAD8 as much as an hour or more beforehand. Therefore in Precise Analysis Mode the RAD8 is averaging the radon concentration from less than 20 minutes ago (polonium-218) with the radon concentration from less than three hours ago (polonium-214). Since this causes the instrument to respond more slowly to changes in radon concentration, extended tests in Precise Analysis Mode can use Cycle Times of up to two hours without the loss of time resolution.

Where there is a requirement for a fast response and detailed time resolution, the Cycle Time may be set as short as 5 minutes, and the Analysis Mode should be set to Rapid, rather than Automatic. If an unsuitable Analysis Mode is chosen it can be changed later using Capture software. Note however, that when counting only Window A, and only for short periods, the number of counts per cycle will be significantly lower than for longer cycles in Precise Analysis Mode, and so the individual readings will be more scattered, exhibiting statistical noise. Finally, if the thermal printer is being used, it will consume more paper, because a printout is typically completed at the end of each cycle.

5.2.5 To Print Or Not To Print

It is not necessary to connect the optional thermal printer during a measurement, because all data, including the detailed spectra, are recorded to the RAD8's memory, and this information remains available for printing or downloading to a computer at any time. Furthermore, with no printer and the RAD8 controls locked, it is impossible for any unauthorized snooper to read the radon concentration during the test. On the other hand, use of a printer gives a convenient and informative hard copy of the results. For routine continuous monitoring, it is usual to set the Cycle Summary Type to Basic by going to the System Settings Screen and choosing Printing Settings.

Connect the printer to the RAD8 and switch the printer on. Power the RAD8 off, and then on again. Information about the RAD8 and its current setup will print out. Data will be printed at the end of every cycle, and a summary, bar chart and cumulative spectrum will print at the end of the test.

5.2.6 Running the Test

When everything is configured, start the radon test. The pump will start running and the RAD8's touchscreen will display a real-time summary of the testing progress.

At any time, the RAD8's status can be viewed. The relative humidity and temperature parameters are worth observing. Rising relative humidity may indicate that the desiccant is exhausted, or that there is a leak in the air sample path. The temperature reading gives a base for future reference, as explained below.

5.2.8 Finishing the Test

Even if no printout has been made at the end of every cycle, it may still be useful to have a printout at the end of the test. If the RAD8 can be accessed before the test is finished, simply connect the optional printer to the RAD8 and switch it on. After the last cycle is completed, the RAD8 will print the test summary, including the mean value, a bar chart of all the readings, and a cumulative spectrum. If the instrument cannot be accessed before the end of the test, the summary can be printed out later.

Switch off the printer and shut down the RAD8. Disconnect the tubing from the desiccant and replace the plastic caps over the hose connectors. If the caps have been lost, a single piece of tubing may be attached between the two connectors, forming a sealed loop to keep the desiccant dry.

Remove the air sample filter assembly from the RAD8. Consider connecting a short piece of tubing between the Sample In and Sample Out ports. This keeps the internal space of the instrument sealed and thus dry, while still allowing air flow if or when the pump starts running. Close the RAD8 enclosure and latch it shut.

When moving the RAD8, treat it with respect. It is rugged, but it is still an electronic instrument. Avoid hard knocks and very harsh environments.

5.2.9 Examining the Data

Data may be examined on the RAD8 touchscreen, during or after a test. The records may also be downloaded to a computer and/or saved to Capture Cloud, where they are then available for creating graphs and tables for printed reports.

On reviewing a set of data, first check that the relative humidity in the instrument stayed below around 10% throughout the measurement. If it rose above 10%, it suggests that the desiccant was either removed, or became depleted. The temperature during the measurement should remain fairly steady. Sudden changes of temperature in the record may suggest that the testing conditions changed unexpectedly, as could occur if the testing environment was ventilated or the RAD8 was moved to a different location.

5.3 Sniffing

5.3.1 Why Sniff?

There are two main reasons for sniffing. One is to obtain a quick, spot reading of radon concentration, as a simpler substitute for grab sampling, and the other is to locate radon entry points. For each application, the method will be slightly different.

5.3.2 Locating Radon Entry Points

There is a very good chance that thoron will be present in the soil gas entering a building. However due to its short half-life, thoron will be detectable only close to the entry points. Therefore if thoron is in the soil gas, it can be considered as a tracer for fresh radon gas. Sniffing to locate radon entry points may thus involve detecting thoron, to speed and simplify the process. The same procedure will also give radon concentrations, provided that the sampling point is kept at one spot for at least 15 minutes.

5.3.3 Preparation

On the Select Test Protocol screen, select the Sniff Test Protocol. Then go to the System Settings screen and use the Audio Settings menu to enable the detection event sound. For detailed instructions on the RAD8 configuration, see Section 1.5. Connect a Small Drying Tube to the RAD8 using 3 ft. of tubing. The end of the tube attached to the filter assembly should be connected to the RAD8's Sample In port, and the other end should be connected to the Small Drying Tube.

5.3.4 Purging

While it is always good practice to purge the instrument before using it, there is less necessity before sniffing. In Sniff Protocol the pump runs continuously, so the air sample will be flushed through every minute or two, and the measurement chamber will quickly dry out, even if the relative humidity starts above 10%.

To bring the humidity in the instrument down without wasting desiccant, the RAD8 outlet may be connected to the open end of the drying tube, making a closed loop, during the purge cycle.

After detecting high concentrations of radon and/or thoron, it is good practice to purge the instrument immediately after use.

5.3.5 Running the Test

Holding the Small Drying Tube as a wand, start the test. The Summary panel on the Test Status Screen will appear. The number of counts per minute (cpm) for thoron appears in the B Window. You may also listen to the beeps, which have a different pitch for different windows. Thoron produces a high-pitched beep.

Floor/wall, wall/wall and split-level seams are common locations for radon entry points. So are sumps, wells, beam pockets and utility conduits, entering the building from below ground level. Before starting the sweep it may be useful to sketch a map of the area, leaving space for writing the thoron reading at each of the likely entry points. While making this map, the RAD8 can be taking a benchmark radon measurement in the center of the room. Take at least four 5-minute-cycle readings. Later radon readings, at likely entry points, can then be compared with this benchmark.

To start the sweep, hold the Small Drying Tube as a wand, with the open end either in, or as close as possible to, the most likely radon entry point. Keep it there for at least five minutes. If the thoron count rate in Window B exceeds approximately 2 cpm, then you know a) that you were right in your suspicion and are close to a radon entry point, and b) that thoron is present in the soil gas, so you can concentrate on thoron for the rest of the survey. Move the wand a foot or so in any direction to see if the Window B cpm changes appreciably during the next Cycle.

If there are few or no counts in Window B, then either the location is not a radon entry point, or there is no appreciable thoron in the soil gas. In this case you must keep the wand in the same position for another 10 minutes, or until the counts in Window A start to rise rapidly. If after fifteen minutes there are still only a few counts in Window A, and the radon concentration, displayed at the end of the third 5-minute cycle, is still very low, then you can be confident that the position is not a radon entry point. On the other hand, a high radon concentration, without thoron, does not necessarily indicate a radon entry point if the whole basement is high. In either case, you need to note the reading on your map, and move to another likely point to repeat the process, first looking for thoron.

If no thoron is found at any time, then the map of radon concentrations will help to identify entry points. Once thoron has been detected, the whole search is made much easier. Spend one complete cycle at each suspected radon entry point, observing the counts in Window B, or listening for the characteristic thoron beeps. You will quickly determine the location and relative strengths of the radon entry points, from the cpm in Window B, for the different locations. Note that in this procedure you must ignore the counts in Window A, because they refer to radon that entered the measurement chamber as much as 10 minutes previous to the observed counts.

Even if thoron is present at some points, there is still a possibility that there may be a radon entry point showing little or no thoron. This could occur if the path taken by the soil gas was very long, or the flow was slow. Conduit for a utility service, or a path up a hidden shaft in a wall, could delay the entry of the soil gas by several minutes. Each minute's delay halves the concentration of thoron (but not radon).

5.3.6 Drilled Sampling Points

Some mitigators drill a number of test holes through the concrete slab, to sniff the soil gas beneath and to test the communication between different areas of the slab. They then install the suction points of the mitigation system where the sub-slab radon readings are highest. This approach is complementary to the search for actual radon entry points, as described above. Both methods are likely to result in a similar, final configuration of the mitigation system, though locating the entry points can also indicate where additional sealing is required.

5.3.7 Spot Readings

A spot reading may be accepted only as a rough indicator of the radon level at any location. This is not only because a short-term reading is less precise, but also because it does not average out the fluctuations in radon level through a typical day. Quite often, the indoor radon concentration tends to be higher in the early morning, after a cold night, and lower at the end of a warm day.

Furthermore, the radon concentration typically takes hours to recover from open doors and windows, so unless the house was closed up tight for many hours beforehand, the spot-reading radon level will be significantly lower than an average taken over several days in closed house conditions.

For this spot reading the sampling point should be away from walls and floor. Thoron is not an issue in this measurement, so the large Laboratory Drying Unit may be used, instead of a Small Drying Tube. The Cycle Time may be left at five minutes. At least four Cycles should be taken, but the first two should be ignored. Alternatively, increase the Cycle Time to 10 minutes, or more, and ignore the first reading.

To measure a radon level of 4 pCi/L with a standard deviation of no more than 10%, the RAD8 must run for 60 minutes (for example six Cycles of ten minutes).

5.4 Grab Sampling

5.4.1 Applicability

The ability of the RAD8 to “grab” a collected sample is useful when it is not possible to take the RAD8 to the location to be tested, or when the RAD8 is preoccupied with continuous monitoring and will not be available until later. The Grab functionality is also useful when many samples must be gathered from different rooms of a building within a short timeframe.

However, if the RAD8 is available and can be taken to the test location, then data quality is much improved by a) monitoring the radon level over an extended period of time, such as 1-day, or, if that is not a possibility, b) making a short-term measurement such as described in Section 5.2.10, or else just sniffing for a spot reading, as described above.

Grab samples have the same shortcomings as spot readings. The radon concentration ‘grabbed’ is not necessarily representative of the average level at the sampling location. The precision of the reading is also limited by the short time for counting.

5.4.2 Preparation and Protocol

It is important that the RAD8 be well dried out prior to accepting the grab sample. First, purge the unit with fresh, dry air for at least five minutes. Then connect the Laboratory Drying Unit in a closed loop with the RAD8 so that air from the outlet passes through the desiccant and back into the inlet. Note that air should always flow out of the bottom end of the Laboratory Drying Unit. Purge the RAD8 until the reported relative humidity drops below 8%. Keep the pump running until you are ready to take the grab sample.

On the Main Menu, choose Start Test and select the Grab Test protocol from the list. This will set up all the measurement parameters correctly.

5.4.3 Taking the Sample

If the RAD8 is at the correct location, simply start the test. Alternatively, samples may be collected in tedlar air sampling bags. Samples of at least five liters are required. Any sampling pump may be used, including the RAD8’s internal pump. Simply remove the tubing bridge between the ports labeled ‘Pump Out’ and ‘Detector In’ on the front panel, attach the Tedlar bag to the ‘Pump Out’ port, and attach your sample inlet tubing to the ‘Detector In’ port. These bagged samples may be re-connected to the RAD8 and analyzed later. Make sure the Laboratory Drying Unit and sample air filter assembly are in place, between the sample bag and the RAD8, during the measurement.

5.4.4 Analysis

With the grab sample source connected to the RAD8 sample air inlet, start the test. The pump will run for five minutes, flushing the measurement chamber, and then stop. The RAD8 will wait for five more minutes, and then count for four 5-minute cycles. The measurement process takes 30 minutes in total. If the analysis is made more than an hour after the sample was taken, a correction must be applied for the decay of radon in the sample.

5.5 Thoron Measurement

5.5.1 Thoron and Radon

Thoron is an isotope of the element radon having an atomic mass of 220, so it is also known as radon-220. The word "radon" without a mass number almost always refers to radon-222. Thoron and radon have very similar properties. They are both chemically inert radioactive gasses that occur naturally from the decay of radioactive elements in soils and minerals. Both thoron and radon are members of decay chains, or long sequences of radioactive decay.

While radon results from the decay of natural uranium, thoron results from the decay of natural thorium. Both uranium and thorium are commonly found in soils and minerals, sometimes separately, sometimes together. The radioactive gasses radon and thoron that are produced in these soils and minerals can diffuse out of the material and travel long distances before they themselves decay. Both radon and thoron decay into radioactive decay products, or progeny, of polonium, lead, and bismuth before finally reaching stable forms as lead. For more information on the radon and thoron decay chains, see Section 4.1.

Thoron and radon and their respective progeny differ very significantly in their half-lives and in the energies of their radiations. While radon has a half-life of nearly 4 days, thoron has a half-life of only 55 seconds. Since thoron is so short-lived, it cannot travel as far from its source as radon can before it decays. It is commonly observed that compared to that of radon gas, a much smaller fraction of the thoron gas in soil ever reaches the interior of a building. Even so, thoron can still be a hazard since its progeny include lead-212 which has a half-life of 10.6 hours, more than long enough to accumulate to significant levels in breathable air.

5.5.2 Thoron Measurement Issues

Many difficulties impede the accurate measurement of thoron gas. The presence of radon gas (often found together with thoron) can interfere with a measurement. The short half-life of thoron gas makes some aspects of the measurement easier, but makes sampling method a critical issue. Thoron concentration can vary greatly through a space, depending on the speed and direction of air movement as well as turbulence. The position of the sample intake can strongly affect the results.

In many instruments, radon and thoron interfere with each other. Generally speaking, it is difficult to measure one isotope accurately in the presence of the other. But compared to other instruments, the RAD8 is much less susceptible to radon-thoron interference due to its ability to distinguish the isotopes by their unique alpha particle energies. The RAD8 separates radon and thoron signals and counts the two isotopes at the same time with practically no interference from one to the other.

Some issues of concern in measuring radon do not apply to thoron. The short half-lives of thoron (55 seconds) and its first decay product (polonium-216 - 0.15 seconds) mean that thoron measurements can be made quickly and in rapid succession, since there is little concern with growth and decay delays. The RAD8 responds virtually instantly to the presence of thoron; its time constant for response to thoron is less than 1 minute. The chief limit on the thoron response speed is the RAD8 pump's ability to fill the

measurement chamber. The RAD8 clears just as rapidly when you purge the instrument with thoron-free air. In fact you need not purge the instrument at all between thoron tests, because thoron's short half-life ensures that it will be gone in a few minutes.

In thoron measurement the sample pump must run in a continuous fashion, at a steady consistent flow rate. If the flow rate of the sampling pump changes, the RAD8 thoron result will also change. Flow rate affects the amount of thoron in the RAD8's internal measurement chamber, since a significant fraction of the thoron decays in the sample intake system as well as within the instrument. In most of the RAD8's built-in analysis modes, the pump runs for two minutes out of every 5, with only the counts recorded during the second minute being used in the calculation of the reported thoron concentration, ensuring that all 5-minute RAD8 'Data Slices' have valid thoron data. When using Sniff Protocol, the pump runs with 100% duty cycle, and counts occurring during the entirety of each 5-minute Data Slice are used in the thoron calculation.

The RAD8 measures thoron concentration in the air at the point of sample intake. Since thoron varies from place to place depending on the motion of the air, the instrument operator may find it necessary to make measurements in several locations to properly assess a thoron situation. Fortunately, rapid-fire thoron measurements are very easy to do with the RAD8.

5.5.3 Calculation and Interference Correction

The RAD8 calculates thoron concentration on the basis of the count rate in spectrum Window B, which is centered on the 6.78 MeV alpha line of polonium-216, the first decay product of thoron gas. To further avoid interference from radon, the RAD8 applies a correction to the thoron count rate to compensate for a tiny percentage of "spillover" from Window C.

If the spill from Window C to Window B is too great relative to the base amount in Window B, it becomes impossible to calculate thoron concentrations with sufficient certainty. This situation can be avoided by purging the RAD8 with fresh air and waiting with the unit turned off for two hours prior to testing for thoron. This provides enough time for the peak in Window C to decay to one tenth of its original value. The threshold above which thoron concentration readings can be attributed to thoron with 95% confidence is called the Minimum Thoron Threshold (MTT). See Section 4.5.1 for more details.

The RAD8 calculates radon concentration from the count rate in Window A (Sniff Analysis Mode) or Windows A plus C (Normal Analysis Mode). The RAD8 compensates for interference from the long-lived progeny of thoron (10.6 hours) by applying a correction to the radon count rate in both Rapid and Precise Analysis Modes. The correction is based on a fixed fraction of the count rate in the D window (around the 8.78 MeV peak of polonium-212) which predicts the amount of thoron progeny activity in the A window (due to the 6.05 and 6.09 MeV peaks of bismuth-212). The uncertainty figures that accompany each reading include the effect of these corrections.

5.5.4 Avoiding Longer-Lived Decay Products

Although the RAD8 corrects for the buildup of the long-lived thoron progeny (10.6 hour), exposure of the instrument to high levels of thoron for long periods of time can make low

level radon measurements somewhat less accurate than would otherwise be possible, due to the thoron-genic counts in the A window. For that reason, it is best to avoid measuring high levels of thoron immediately before low levels of radon. However, should such an exposure occur, the 10.6 hour half-life of the thoron progeny makes for a temporary inconvenience of a few days at worst, after which the thoron-genic count rate in the A window will have recovered to its extremely low intrinsic background level.

5.5.5 Standard Thoron Setup, Thoron Calibration and Flow Rate

As discussed above, thoron's rapid decay causes the intake path and the air flow rate to become important factors in calibration. The RAD8 factory calibration for thoron is based on a standard RAD8 inlet filter, a standard 3-foot long, 3/16 inch inner diameter vinyl hose, and a standard Small Drying Tube, which is about 6 inches in length. Deviation from this arrangement can change your thoron results. For example, if you were to use a very long hose for thoron sampling, then the sample might decay significantly before it ever reached the instrument inlet. Additionally, if you were to use a non-recommended inlet filter, the flow might be restricted enough to greatly lower the result. For more details, see Section 5.5.9.

5.5.6 Calculating Sample Decay

The thoron concentration at the inlet of the RAD8, C1, can be expressed mathematically as

$$C1 = C0 * \exp(-L * V1 / q)$$

where C0 is the original sample concentration, V1 is the volume of the sample tube + drying tube + filter (around 50 mL), q is the flow rate (around 0.6 L/min), and L is the decay constant for thoron (.756 /min). A typical value for C1/C0 is then

$$C1/C0 = \exp(-.756 * 50 / 550) = 0.934 = 93.4\%$$

This is the number Durrige assumes in the factory calibration. Adding a few extra feet of hose will not matter much (about 0.7% per foot), but if we were to use a 100 foot hose instead (in which case V1 becomes around 580 mL) then the same calculation would give 00.451 or 45.1%, a significant reduction from 93.4%!

5.5.7 Calculating Internal Measurement Chamber Concentration

The sample decays slightly in going from the RAD8 inlet to the instrument's internal measurement chamber, due to internal hose and filter volumes. This decay can be calculated in a similar fashion to the above, giving the measurement chamber concentration, C2. Within the RAD8 measurement chamber, the equilibrium thoron concentration, C3, will be determined by the following formula:

$$C3 = C2 / (1 + L * V2 / q)$$

where L and q are as above, and V2 is the volume of the measurement chamber (around 500mL). Typical values then give C3/C2 as

$$C3/C2 = 1/(1+.756 * 500/550) = 0.593 = 59.3\%$$

Multiplying this result by the sample decay factors calculated above, we obtain an overall concentration in the measurement chamber of the original sample.

5.5.8 Measurement Chamber Thoron Sensitivity Calibration

Preliminary investigations have shown that the thoron sensitivity in cpm/(pCi/L) of a RAD8 running the pump set to ON is equal to 0.32 times its radon Rapid Analysis mode sensitivity. With the pump mode set to Standard, this factor is 0.15. Presently, we are programming all new RAD8s according to these empirical results, and claim an uncalibrated thoron precision of $\pm 30\%$.

With calibration against a thoron standard assessed by gamma spectrometry we are able to state the thoron sensitivity with higher certainty. This thoron calibration is offered as an option and for this we claim an overall accuracy of $\pm 20\%$. The RAD8 has a typical radon Sniff sensitivity of 0.40 cpm/(pCi/L), so we estimate the typical thoron sensitivity to be around 0.13 cpm/(pCi/L).

5.5.9 Setting up a Thoron Measurement

For a quantitative measurement of thoron it is necessary to use the Standard Thoron Setup and protocol. The Standard Thoron Setup consists of a Small Drying Tube, used as a wand for sniffing, with a standard input tubing of 36" (91.4cm) length and inner diameter (ID) of 3/16" (4.8mm); see the diagram on the following page.

The Small Drying Tube should be filled with fresh (blue) desiccant. Always use an inlet filter, free from flow restrictions or clogs. Avoid obstructing the intake of the sample tube.

For the most accurate results, check the flow rate with a meter (rotameter or "floating ball" type) to be sure it is consistent from measurement to measurement. Note that the flow rate affects the thoron reading, but not the radon reading due to radon's much longer half-life.

Choose the Sniff preset protocol for 5-minute repeating Cycles and continuous pump operation. Before making a measurement, be sure the instrument has been purged to dry it out, as described in Section 2.3.8. Position the sample tube intake and start the test.

For accurate thoron measurement, always use this sample taking arrangement.

The polonium-216 daughter of thoron has only a 145 ms half-life, so the main component in the response time of the RAD8 to a step change in thoron concentration is the time taken to acquire the sample. The response is virtually instantaneous.

Sniffing for thoron is much the same as sniffing for radon, except it tends to be a little faster. If you are just "prospecting", you probably will not be very interested in getting the most accurate results possible, so technique is not critical. But if you are trying to make an accurate measurement, technique is of great importance.

5.5.10 Sniff Protocol for Thoron Measurement

The Sniff Protocol causes the RAD8 pump to run continuously to assure a fresh sample, increasing the instrument's effective thoron sensitivity. Under Standard pump operating conditions, the pump runs for two minutes in every five. The thoron sensitivity is close to zero when the pump is not running, so running the pump continuously increases the thoron sensitivity by a factor of approximately 2.

Running the RAD8 in Sniff Protocol does not hinder the instrument's ability to measure radon. Note that valid thoron measurements require that the RAD8 be configured with a Small Drying tube and the appropriate tubing length. For more information on Protocols, see Section 2.3.2.

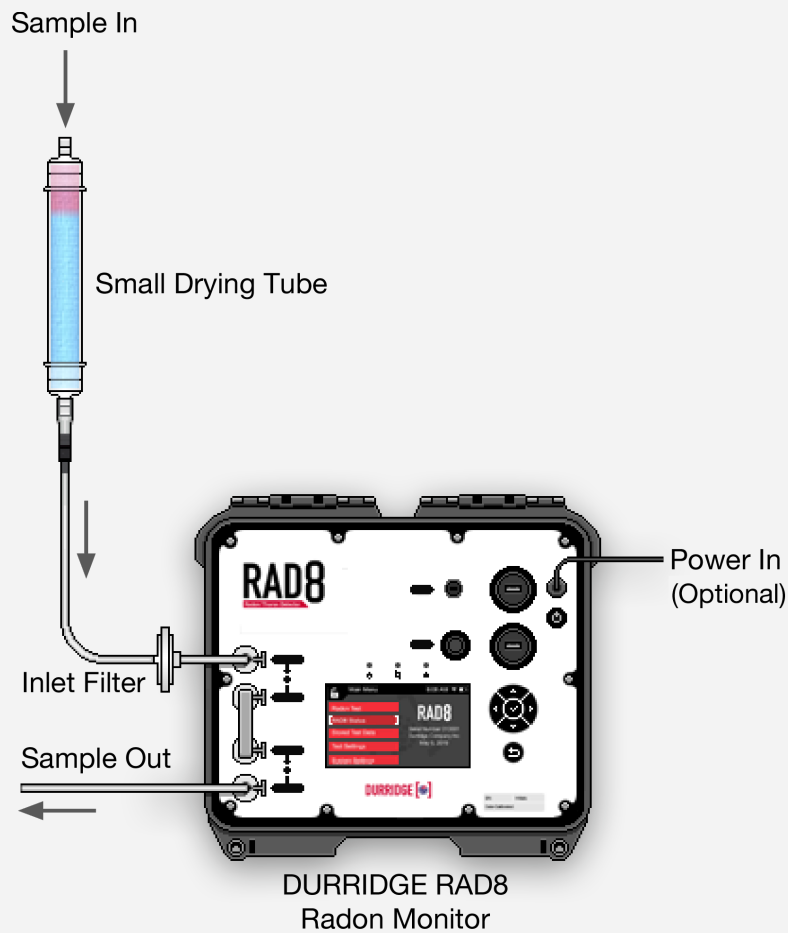

Recommended RAD8 Thoron Configuration



Tubing Port Connections Required: As with the Standard Configuration described in Section 1.4.1, the RAD8 Thoron Configuration shown above requires tubing connections in each of the RAD8's four air ports. The Tubing Bridge accessory should snap into place, spanning the gap between the Pump Out and Detector In ports.

5.5.11 Thoron Measurements in Standard Pump Mode

When the RAD8 is being primarily used for measuring radon, each 5-minute Data Slice begins with two minutes of continuous pump activity, followed by three minutes with the pump off. The RAD8 is only sensitive to thoron whilst the pump is running (and for a short time thereafter), giving an effective thoron sensitivity approximately 2/5ths of the value when the instrument is running in dedicated Sniff Protocol with the pump set to ON. The RAD8 is programmed with separate thoron sensitivities for Standard and ON pump modes, and applies the appropriate sensitivity automatically. If a Laboratory Drying Unit is used instead of a Small Drying Tube, the effective thoron sensitivity will be reduced slightly due to the extra time taken for the thoron to reach the RAD8 measurement chamber.

5.6 Managing Background

A major concern in radon testing is background. The RAD8 has a number of features that help to keep short and long-term background under control. For more information see Sections 3.10 and 3.11. Following a few simple rules will help to keep background to a minimum.

Short term background is activity left in the detector after the air sample has been flushed from the measurement chamber. The higher the radon concentration and the longer the sample is held in the chamber, the more short-lived progeny activity it leaves behind. So to avoid this short-term background, when you see high radon readings, purge the RAD8 promptly after the measurement. Take the instrument somewhere with little radon, such as outdoors. Make sure the drying tube is connected, and purge the RAD8 for 5 to 10 minutes, or longer if the sample was exceptionally high in radon.

The two radon-genic alpha peaks (A and C) decay at different rates. The polonium-218 peak in Window A decays with a 3.05 minute half-life. So in 10 minutes it will be down to about one-tenth of its original count rate. However the peak in Window C will take over two hours to get down to one-tenth its count rate.

Rather than wait around for hours, you can start the next radon test in Rapid Analysis Mode, which ignores Window C. In fact, the preset, one and two-day, monitoring protocols, in the RAD8, start the measurement in Rapid Analysis Mode and automatically change to Precise Analysis Mode after three hours. This takes care of all but extreme exposure to very high radon.

You can always measure the short-term background, with 5-minute Cycles, and Analysis Mode set to Rapid. Record a short test consisting of a few Cycles to make sure the background is low.

5.7 Airflow Rate Limits

When the RAD8's pump is not running it is permissible to use an external pump device, such as the DRYSTIK, which may provide a higher or lower airflow rate than the RAD8's built-in pump. However, certain flow rate limits should be observed.

High flow rates are useful for thoron measurement and for fast response RAD AQUA monitoring of radon and thoron in water. Low flow rates are useful for continuous soil gas monitoring and for sampling gasses, such as stack gasses, that need significant conditioning.

5.7.1 Maximum Airflow Rate

The maximum recommended airflow rate is 2.5L/minute. Beyond that rate the RAD8's sensitivity will eventually drop, because the very fast movement of air interferes with the electrostatic precipitation process. Airflow rates approaching the 2.5L/min limit are suitable for measuring thoron, which must be brought into the RAD8 swiftly due to its rapid decay.

If the RAD8 has been specifically calibrated for thoron however, the specified thoron sensitivity will remain in effect only when the RAD8 is configured exactly as instructed on the Thoron Calibration Certificate. Generally this entails operating the RAD8 in Sniff Protocol, causing its internal pump to run continuously, producing an airflow rate of about 0.6 L/min.

5.7.2 Minimum Airflow Rate

With Pump Mode set to Standard, the RAD8's pump runs for two minutes in every five, to keep the air sample fresh. Therefore, the typical average flow rate is roughly 0.25 L/min. For certain applications lower airflow rates may be preferred. To determine the minimum acceptable airflow rate, consider the following parameters:

- a) The distance from the sample source to the RAD8 (very slow flow rates may allow significant radioactive decay of the radon before it reaches the RAD8).
- b) Whether thoron is being measured (with a one-minute half-life, sample decay during acquisition is significant).
- c) The required response speed of the RAD8 (a low flow rate may cause an unacceptably long time to completely refresh the sample in the measurement chamber).
- d) The radioactive decay during residence in the RAD8's measurement chamber.

Regarding point c), the amount of time it takes to change the measurement sample should be short compared to the required response time.

Regarding point d), the radon sample in the measurement chamber should have nearly the same concentration as the radon at the sampling point, to within a small fraction of the acceptable uncertainty. Ideally less than 1% of the original sample concentration will be lost to radioactive decay before the measurement occurs. This requires that the transit time from the sampling point plus the time that radon remains in the RAD8's chamber is less than one hour. The RAD8 has a volume of less than 1 L, so a flow rate of 1 L/hour, or

0.016 L/min is sufficient to satisfy the residence criterion, but the response time to a step change in radon concentration at the sampling point would then be about 1 hour. For a 15 minute response time, the flow rate would have to be at least five times greater, or 0.08 L/min.

The 3-minute half-life of polonium-218 limits the radon response time to a little less than 15 minutes, so there is little benefit in a flow rate greater than 0.1 L/min unless the source is far away, or thoron is being measured.

5.8 Harsh and Hazardous Environments

5.8.1 Dusty Environment

Dust may contaminate the desiccant and cause elevated radon background due to radon emitted by trace amounts of radium deposited in the desiccant by the contaminating dust. To prevent this, a dust filter should be attached to the tubing at the sampling point, upstream of everything.

A suitable dust filter is supplied with every RAD8. The filter should be replaced when it becomes soiled. Replacements may be purchased from a car-parts supplier as 1960's VW Beetle in-line gasoline filters, part number 803-201-511C, or FRAM G4164, or from DurrIDGE Company.

Please note that any restriction to air flow, including a plugged dust filter, upstream of a passive DRYSTIK will reduce the effectiveness of the DRYSTIK. In a dusty environment, with a dust filter in place, an Active DRYSTIK will continue to work well even if the dust filter becomes partially blocked.

5.8.2 Radiation Hazard

If the RAD8 is to be placed in a location that is hazardous to the health of individuals, remote communication may be established through a wireless network connection. For details please see Section 6, and the Long Distance Connectivity section of the Capture user's manual. (The Capture manual is available from within the program's Help Menu, as well as from the DurrIDGE website.)

Note that the RAD8 electronics are not radiation hardened, so in extreme environments, shielding for the device may be needed.

6 USING RAD8 ACCESSORIES: TESTING SOIL AND WATER

6.1 Introduction

With the addition of various accessories offered by DurrIDGE, the RAD8 can acquire the ability to detect radon in water samples, flowing water, soil gas, hard and soft surfaces, and objects. These applications and the accessories required for each are described below.

The accessories discussed here are not included with the RAD8. For full details on the usage of a given accessory, please see its user manual. All product manuals are available on the DurrIDGE website (<http://durrIDGE.com/>) in PDF format.

6.2 Radon in Water

6.2.1 The RAD H₂O and Big Bottle Systems

The RAD H₂O is an accessory for the RAD8 that enables you to measure radon in collected water samples with high accuracy over a wide range of concentrations, obtaining your reading within half an hour of taking the sample. It is particularly suited for well water testing, where immediate results are often required.

The RAD H₂O uses a standard, pre-calibrated degassing system and pre-set protocols, built into the RAD8, which give a direct reading of the radon concentration in the water sample itself. The most widely supported sample sizes are 40 mL and 250 mL, as these correspond to the RAD8's built-in RAD H₂O 40 ml and RAD H₂O 250 ml protocols. Large water samples of up to 2.5L may be sampled using a separate product, the Big Bottle System, in which radon concentrations are calculated using the provided Capture software for Windows and macOS.

The RAD H₂O and Big Bottle System manuals contain further information on these products.

6.2.2 The RAD AQUA Accessory

The RAD AQUA accessory handles the continuous monitoring of radon in water, offering accurate results in as little as half an hour. Applications for the RAD AQUA include testing water from running faucets and water being pumped from the bottom of a lake. In addition to its rapid response time, the RAD AQUA offers a high degree of sensitivity.

The RAD AQUA functions by bringing the air in a closed loop into equilibrium with water passing through an exchanger. The RAD8 is set to operate in continuous mode (as described in Section 4.2), sampling the air in the loop and recording its radon and thoron activity concentration.

Since the partition coefficient of radon in air to radon in water is affected by temperature, a temperature probe is used to collect water temperature data. DurrIDGE Capture software for Windows and macOS later accesses the RAD8 data and the water temperature data and calculates the final radon in water readings.

Users are encouraged to refer to the RAD AQUA manual for further details.



6.2.3 The Water Probe Accessory

The Water Probe is used for long-term, slow-response monitoring of radon activity concentrations in large bodies of water. The probe consists of a semi-permeable membrane tube mounted on an open wire frame. The tube is placed in a closed loop with the RAD8.

When the probe is lowered into water, radon passes through the membrane until the radon concentration of the air in the loop is in equilibrium with that of the water. As with the RAD AQUA, the RAD8 data and water temperature data are collected simultaneously and accessed by Capture to determine the final radon-in-water result.

As compared to the RAD AQUA, the Water Probe takes longer to make a spot measurement. However, it does not require a water pump, and the resulting low power requirements are well-suited to long-term monitoring.



6.3 Soil Gas Sampling

6.3.1 Application

The radon concentration in the soil gas surrounding a building is one of many parameters that impact the radon health risk to the occupants. The construction of the building, the porosity of the soil, the height of the water table, and several other factors are all important. Even if there is no radon in the surrounding soil, the building may still be at risk if it has a well in the basement, or is built on rock, over a fissure. Regardless, it is often of interest to determine the radon concentration in soil gas.

Thoron is usually associated with radon in the soil. When measuring soil gas, it is therefore particularly useful to determine the thoron content as well as the radon content. Should there be a sufficient thoron, it may be used as a tracer, to find radon entry points inside the building. See Section 5.3.2 for details.

6.3.2 The Soil Gas Probe Accessory

The cost and complexity of a soil gas probe increases with the depth to which it can be inserted. A choice of two probes is available from DurrIDGE: one made from stainless steel for use in most soils, and one made from hardened steel for use in more hard-packed or clayey soils. Both probes will penetrate to a depth of 3 feet, which for most soils is deep enough to escape surface metrological effects such as rain and barometric pressure fluctuations. Such effects can strongly influence radon concentrations in the top 70 cm or so of the soil.

6.3.3 Soil Gas Probe Preparation

For full details on using a soil gas probe, please refer to the appropriate user's manual found at the DurrIDGE website (<http://durrIDGE.com>). The basic procedure can be summarized as follows.

Insert the soil probe. Make sure that there is a very good seal between the probe shaft and the surrounding soil, so that ambient air does not descend around the probe and dilute the soil gas sample.

Between the probe and the RAD8, connect the included Water Stop assembly, which includes a pressure gauge to give an indication in the event that the air sample line becomes blocked, either deliberately by the trap in the event of liquid water in the sample line, or by accident, for example by clogging of the probe tip. Then, connect the Laboratory Drying Unit, and the inlet filter.

Set the RAD8 to the Sniff Protocol. Soil gas is normally so high in radon that it is not necessary to use long Cycle Times to achieve good statistical precision. The minimum five minute Cycle Times are usually sufficient.

6.3.4 Running the Test

Start the test and navigate to the Test Status > Summary screen, which will display the temperature, relative humidity and pump current. Pay particular attention to the relative humidity and pump current. The humidity should gradually drop down to below 10%, and stay there.

If the reading on the Water Stop assembly pressure gauge rises significantly, or the pump current starts to rise much above 100 mA, it suggests that the soil is not porous, in which case it may be that a good soil gas sample cannot be drawn, no matter how powerful the pump is. With the RAD8 pump current above 100 mA, the air flow rate will be significantly reduced from the nominal 0.6 L/min. This will not affect the radon reading, but will reduce the effective sensitivity to thoron, as more of the thoron will decay en route to the RAD8. If desired, an external pump may be used, but it should be placed upstream of the RAD8's measurement chamber (pump outlet pushing the sample air directly into the 'Detector In' tubing port), so that the RAD8 is operating at normal pressure. With an external sampling pump in use, the RAD8 pump mode should be set to Off.

6.3.5 Interpreting the Data

As with any Sniff test, the first two 5-minute cycles should be ignored. The next one or two cycles should be averaged, to arrive at the radon concentration of the soil gas.

For thoron, some estimate has to be made of the time taken for the sample, after it has left the soil, to reach the RAD8. This requires an estimate of the volume of the sample path, including the probe, water trap, tubing and drying unit, and an estimate, or measurement, of the flow rate. For example, if the total volume of the sample path is 2 L, and the flow rate is 0.5 L/min, then the sample delay is about 4 minutes. If the thoron decays by half every minute, then after four minutes the concentration will be just 1/16th of the concentration in the ground. So, the thoron concentration measured by the RAD8 would be multiplied by 16. See Section 5.5.6 for more details.

6.4 Emission Measurements

6.4.1 Application

With its internal pump, sealed sample path, and inlet and outlet connectors, the RAD8 is well suited to the measurement of radon emissions from objects and surfaces. Furthermore, the ability to count only the polonium-218 decays (Rapid Analysis Mode) means that dynamic measurements are clean, and not complicated by long-half-life decays.

6.4.2 Open-Loop Configuration

Emissions may be sampled from objects and material samples using DurrIDGE's Bulk Emission Chamber. It is also possible to analyze emissions from soft or hard surfaces, with the aid of a DurrIDGE Surface Emission Chamber, which consists of a plate-like enclosure capable of forming a tight seal around the surface in question. In both cases the RAD8 draws air from within the enclosed space, through the desiccant and inlet filter, and into the measurement chamber. The air may then be returned to the enclosure from the RAD8

outlet, to form a closed loop. Alternatively, in an open loop configuration the air being drawn from the enclosure may be replaced with 'zero' air from a cylinder, or with ambient air, which should have a low but known radon concentration.

With the open loop configuration, a steady and known flow rate must be established. If a pressurized cylinder of 'zero' air is used, then the RAD8's internal pump may be bypassed (using the 'Detector In' port instead of the 'Sample In' port as the air inlet), and a pressure reduction valve and needle valve may be used to control the flow rate. With ambient air, the RAD8's internal pump may be set to On, for a continuous flow. In both cases, a flow meter is required. Once a steady state has been achieved, a long-term measurement may be made. The rate of emission will equal the radon concentration times the flow rate.

6.4.3 Closed-Loop Configuration

In a closed-loop configuration, the system is first purged, then sealed. From the moment the system is sealed, the radon begins to 'grow in' to secular equilibrium with its parent radium-226 in the surface of the object or material sample. Next the radon concentration within the loop is monitored in Rapid Analysis Mode, with short, e.g. 15-minute, Cycle Times, for a few hours. It is necessary to know the total volume of the closed-loop system. For this purpose the volume inside the RAD8 may be taken as 800 mL. The initial rate of increase in radon concentration (neglecting the first 15-minute Cycle), multiplied by the volume, gives the rate of radon emission.

Durridge's Capture software can be used to view a graph slope line and inspect the change in radon concentration over time. The line should be set to begin after the initial response delay and before the ingrowth curve begins to approach secular equilibrium and level off. Capture will express the slope of the line in the units of your choice.

6.4.4 Very Low Emission Rates

Very low emission rates can be measured by placing the sample in an airtight container with sealable inlet and outlet valves, and allowing the ingrowth of radon to occur over at least a week (after which the ingrowth must be calculated) and preferably a month or more (after which the ingrowth is complete, and secular equilibrium established between radon-222 and radium-226). The container is then connected to the RAD8 in a closed loop. The valves are opened and the RAD8 measures the radon concentration. The concentration rises as the radon is distributed around the loop. Eventually the concentration will settle to a steady-state value determined by 1) the strength of the 'radon source' (the radium-226 in the surface of the object or material sample), and 2) the rate of loss of radon from the closed system due to tiny leaks.

6.4.5 Bulk Emissions

The Durridge Bulk Emission Chamber is an airtight box with two well-separated hose connectors. The material to be tested is placed in the chamber, which is then connected to the Laboratory Drying Unit, and thence to the inlet filter on the RAD8. The other box connector has tubing attached, which is either connected to the RAD8 outlet for closed-loop operation, or to a cylinder of zero-radon or ambient air.

Note that bulk emissions are affected by pressure fluctuations and by temperature and humidity. All these parameters can and should be controlled in both the closed-loop and

6.5 The DRYSTIK

The RAD8's sensitivity is maximized when there is zero absolute humidity in the sample air, and drops as humidity increases. The use of desiccant ensures that the air entering the RAD8 is not too humid, but since desiccant is expended quickly when exposed to very moist air, DurrIDGE offers the DRYSTIK, an instrument which removes moisture from the air entering the RAD8 without removing any of the radon itself. The DRYSTIK is capable of reducing the humidity of a typical air sample to 4% in under 20 minutes, greatly prolonging the life of the desiccant, or in certain cases, eliminating the need for it.

The DRYSTIK reduces the humidity of the air entering the RAD8 by transferring moisture from the sample about to enter the RAD8 to the air being pumped out of the instrument. As the air enters the desiccant in the Laboratory Drying Unit (which is not included with the DRYSTIK) on its way to the RAD8, it will have already lost most of its moisture, greatly extending the life of the desiccant. In certain cases the need for desiccant is eliminated altogether.

The DRYSTIK has at its heart a length of coaxial Nafion humidity exchange tubing with diaphragm pump, fixed and variable flow limiters, and a built-in pump duty cycle controller. These are all contained in one of two enclosures, either standard or ruggedized. The DRYSTIK's pump compresses the sample air inside the membrane tubing, initiating the transfer of water molecules to the outer purge flow, drying the incoming air as it moves through the device.

The DRYSTIK is capable of bringing the relative humidity of air flowing at 0.15 L/min down below 10% in less than four hours, and maintaining the RH below 6% indefinitely without any desiccant. This allows a RAD8 to operate under optimum conditions with the highest sensitivity and lowest operating cost.

For soil gas measurement, the DRYSTIK provides a high flow capability, supporting the detection of short-lived thoron. For radon, the ability to lower the flow with the built-in pump duty cycle controller and needle valve flow rate adjustment means that continuous soil gas readings may be made indefinitely, without any risk of fresh air diluting the soil gas sample by diffusing from the surface down to the extraction point. Given its versatility, the DRYSTIK is effective for a wide range of applications.



DRYSTIK ADS-3



DRYSTIK ADS-3R

7 MAINTENANCE

If the RAD8 is treated with respect, the only maintenance required is its regular recalibration. For this, it should be returned to DurrIDGE, who will check the health of the instrument, replace any worn-out components, and update the calibration parameters in the instrument firmware.

7.1 Accessories - Usage and Care

7.1.1 Desiccant

Two sizes of desiccant tubes are supplied. In the Precise Analysis Mode, use the large 2" diameter tube (Laboratory Drying Unit). This unit will last for days under continuous operation at high humidity before it needs regeneration.

When using the RAD8 as a Sniffer, the Small Drying Tube is recommended. It will last for several hours before replacement or refilling of the tube is necessary.

To regenerate the desiccant, the granules should be removed from the tube and spread evenly in an extremely thin layer on a metal or Pyrex glass tray. Heat at about 205°C (401°F) for one hour, or until granules turn uniformly blue. Allow the desiccant to cool in a closed, but not airtight, container before refilling the acrylic Laboratory Drying Unit or Small Drying Tube.

The following sections provide insight into how long the desiccant will last in various scenarios.

7.1.2 Laboratory Drying Unit

The column holds approximately 500 grams of Drierite desiccant. This desiccant can adsorb at least 10% of its weight in water, so the water capacity of the column is at least 50 grams. The RAD8 pump develops a flow rate of about 0.6 L/min. With the RAD8 set for continuous monitoring with timed pump operation, the pump operates 40% of the time. Therefore, we will assume an average flow rate of 0.25 L/min.

The following table shows the expected lifetime of a charge of desiccant in the Laboratory Drying Unit under various temperature and humidity conditions.

Table 7.1.2 Laboratory Drying Unit Life

RH	Deg. C	Deg. F	Column Life
30%	20	68	30.4 Days
30%	35	95	13.3 Days
50%	20	68	18.2 Days
50%	25	77	13.7 Days
90%	10	50	18.6 Days
90%	15	59	13.6 Days
90%	20	68	10.1 Days
90%	25	77	7.6 Days
90%	30	86	5.8 Days

7.1.3 Small Drying Tube

The Small Drying Tubes each contain 30 grams of Drierite desiccant. The water capacity of each tube is 3 grams. We will assume that the RAD8 pump operates continuously, for an average flow rate of 0.6 L/min. The following table shows the expected lifetime of a Small Drying Tube under a variety of temperature and humidity conditions.

Table 7.1.3 Small Drying Tube Life

RH	Deg. C	Deg. F	Tube Life
30%	20	68	17.5 Hours
30%	35	95	7.7 Hours
50%	20	68	10.5 Hours
50%	25	77	7.9 Hours
90%	10	50	10.7 Hours
90%	15	59	7.9 Hours
90%	20	68	5.8 Hours
90%	25	77	4.4 Hours
90%	30	86	3.3 Hours

7.1.4 Cascading Drying Tubes

To extend the time before desiccant depletion, you may cascade several drying tubes in series. Two factors limit the number of drying tubes you can use. First, each additional drying tube or column adds a small amount of resistance to the air flow, so the pump will have to work a little harder. But the resistance added by a drying tube is much less than the resistance of the inlet filter, so you should be able to cascade several without severely restricting the air flow. Second, each additional tube adds a time lag between sample intake and instrument response.

For continuous monitoring, a 10- to 20-minute lag may be perfectly acceptable, but for sniffing it may not be. You can conservatively estimate the time lag by taking four times the volume of the drying system and dividing it by the average flow rate. Consider a continuous monitor application using a Laboratory Drying Unit (with an internal air

volume of approximately 458 mL) with the pump in timed operation, giving an average flow rate of 0.24 L/min. Four times the volume divided by the flow rate gives 8 minutes for the estimated lag time. This would be perfectly acceptable for continuous monitoring. For radon sniffing, you will usually use the less voluminous Small Drying Tubes, which create negligible delays of less than a minute, even at low flow rates. You can cascade several Small Drying Tubes without trouble.

Do not cascade drying tubes when sniffing for thoron, since thoron's 56-second half-life necessitates that you keep delays to an absolute minimum. For thoron sniffing, use a single Small Drying Tube, and set the pump for continuous (on) operation. Keep hose length to 3 feet in keeping with the Standard Thoron Setup, unless your RAD8 has been calibrated for thoron using a non-standard inlet tubing setup.

7.1.5 Filters

The supplied inlet filters block ultra fine dust particles and all pre-existing airborne radon and thoron progeny from entering the RAD8 measurement chamber. The RAD8 should never be operated without an inlet filter in place.

The filters are manufactured in various pore sizes by several companies, including Millipore and SRI. We favor pore sizes of 1.0 microns or less; pore sizes as small as 0.4 microns can be used with the RAD8 pump.

The filter should be replaced when it has become noticeably discolored or has clogged enough to impede the flow of air. If you cannot blow air easily through the filter yourself, it's time to change the filter.

When you operate the RAD8 in construction areas or basements, dust can quickly build up in sampling hoses, drying tubes, and inlet filters. This dust will slowly clog the filter, restrict air flow, and create strain on the pump. You will have to replace the inlet filter. To greatly slow the buildup of dust, we recommend that you attach a "prefilter" to the intake of the sampling hose, to prevent coarse dust particles from entering. Then, the inlet filter will remove the ultra-fine dust particles that pass through the prefilter and drying system.



Inlet Filter Required

Always operate the RAD8 with an inlet filter in place. This prevents contaminants from entering the RAD8's measurement chamber. If radon-emitting material is allowed to enter the RAD8, it will adversely affect the instrument's usefulness. Several inlet filters are included with the RAD8, and additional filters may be purchased from Durrige.

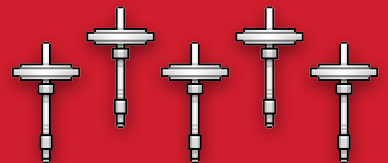

7.1.6 Batteries

The RAD8 uses lithium-ion batteries, similar to a laptop computer. If left in a discharged state for an extended period of time they will lose capacity. After running the RAD8 on battery power, the instrument should be recharged by connecting the power supply and plugging it into an electrical outlet. When plugged in, the RAD8 will recharge even if it is not powered on. When the RAD8 measuring radon, it will recharge more slowly. If the RAD8 is to remain unused for several weeks, the batteries should first be charged to approximately half capacity.

If the batteries are deeply discharged, it will be necessary to plug in the RAD8 and recharge it partially before using it.

The battery state of charge is indicated at the top right corner of the touchscreen display. If the battery ever goes below 1%, it is fully discharged and should be recharged as soon as possible.

7.2 RAD8 Operating Ranges

Parameter	Minimum Value	Maximum Value
Temperature	0°C (32°F)	45°C (113°F)*
Relative Humidity, external**	0%	100%
Relative Humidity, internal**	0%	10%
Pump Current (<i>pump off</i>)	0 mA	10 mA
Pump Current (<i>pump on</i>)	30 mA	90 mA

Table 7.2 RAD8 Operating Ranges

*The RAD8 should not be placed in direct sunlight if the outside temperature is over 38° Celsius (100° Fahrenheit). Instead it should be moved to a shady location.

**The humidity must be non-condensing

7.3 Service and Repair

7.3.1 Calibration

DurrIDGE maintains two professional radon calibration facilities that include a controlled, standard source of radon gas, and a controlled-temperature environmental chamber. All RAD8 alignment and calibration is done here, as well as basic testing and quality assurance. We determine calibration factors by direct comparison to "master" radon monitors, which were themselves compared with EPA and DOE instruments, and which have participated in international inter-comparisons of radon instrumentation. The calibration accuracy is independently verified by direct determination of the radon chamber level from the calibrated activity and emission of the standard radon source. In addition, we periodically intercompare with other radon chambers. We generally achieve a reproducibility of better than 2% with our standard RAD8 calibration. Overall calibration accuracy is in the range of 5%.

The U.S. EPA recommends that continuous radon monitors such as the RAD8 be calibrated at least once per year, and DurrIDGE agrees. DurrIDGE's standard RAD8 calibration procedure requires 10 days from the receipt of the instrument. Prior to recalibration, we give every RAD8 an inspection and test its critical parts. If additional service is required, this may delay the return of the instrument.

At present, only DurrIDGE can make adjustments to your instrument's alignment and calibration factors. If you determine, on the basis of an independent intercomparison (e.g., another calibration chamber) that you would like to adjust your RAD8's calibration by a known amount, we can generally perform this service and send back your instrument within one day. Requested calibration adjustments of more than 10% are considered highly unusual and require the written permission of the instrument's owner.

7.3.2 Repair

If you discover that your RAD8 is malfunctioning, we recommend that you first call DurrIDGE and talk to a technician. A surprising number of minor "disasters" can be averted by long-distance consultation. The next step, if consultation fails, is usually to send your instrument in for evaluation and repair. Please fill out a RAD8 Return Form, and send any documentation of the problem that you might have (notes, printouts, etc.), along with a short description of the problem. This information may be emailed to us at service@durrIDGE.com. Be sure that you put your name and contact information on the note. Bear in mind that RAD8 repairs involve a re-calibration of the instrument, which takes time.

7.3.3 Shipping

1. Please complete the RAD8 Return Form, which is available in the Services section of the DurrIDGE website. Email the form to service@durrIDGE.com before you send your RAD8 back to us. Include a printed copy of the form in the box with the RAD8. You can send your RAD8 to either one of our Calibration facilities (USA and UK), listed below (see **important, specific instructions for each below**).

2. We need the RAD8 in house for 10 days, so the total time a RAD8 will be away from your facility will be 10 days plus the time the RAD8 spends in transit. If additional service or repair is required, this may delay the return of the instrument.
3. When sending your RAD8, please send the instrument only, without the cables and accessories. Pack the instrument upright in a box with one-inch (2.2cm) padding all around. A 14 x 14 x 14 in (or 36 x 36 x 36 cm) box is suitable. Pack the box well, and seal it carefully. Please include your contact info with the package.
4. International customers must be very careful, to avoid substantial extra shipping charges and delays, both for shipping to the nearest calibration facility, and for its subsequent return.

5. Commercial Invoice check-list (for international shipping only)

- For your courier or freight forwarder, you will need to provide a **Commercial Invoice**.
- Write only in English on the commercial invoice.
- Use the following description for the RAD8: “Used RAD8 Electronic Radon Detector”.
- Insured value US\$1,500.
- State on the invoice that the instrument is MADE IN USA and that it is being “**returned to the manufacturer temporarily for repair and recalibration**”.
- Use the HS (Commodity) code 9030.10.0000.
- Mark the box with the serial number of the RAD8 (as the RMA – Return Merchandise Authorization).
- Add the phone number of the Calibration facility you choose, in case the Customs Office wants to call us.
- Next, you must ensure that your courier (i.e. UPS, FedEx) or freight forwarder will **deliver the package to our door**. The formal “INCOTERM” for this is “DDP”, which means “Delivered Duty Paid.”
- We will not pay or be responsible for USA or UK import duties, or Customs clearance charges. Your shipper must be told this when you arrange your shipment.
- It is important to make sure you prepare all the documentation you need to re-import the goods back into your country without being charged.
- For the Return to you:** unless you instruct us otherwise, we will return your RAD8 via the same shipping method you used to deliver it to us, Freight Collect. DurrIDGE can pay for the return shipment CPT (“Carriage Paid To”) to you, but our cost will be invoiced to you before shipment.

If we can help further, please email us at service@durrIDGE.com.

Specific info for SHIPPING TO OUR USA FACILITY (from outside the USA):

DurrIDGE Company, Inc.
 900 Technology Park Drive
 Billerica, MA 01821-2812, USA
 Phone: (+1) 978-667-9556
 Fax: (+1) 978-667-9557

Declaration Form

There needs to be documentation proving that the instrument was previously imported into your country, otherwise you may be charged import duties when the instrument is returned to your country.

Please fill out the **declaration form** provided at <http://durrIDGE.com/services/RAD8-calibration/> . Attach the completed declaration form to the commercial invoice. If the invoice is scanned and submitted electronically, please scan the declaration form and submit it electronically as well.

Specific info for SHIPPING TO OUR UK FACILITY:

DurrIDGE UK Ltd.
Sheffield Technology Park
Cooper Buildings
Arundel Street
Sheffield S1 2NS, UK
Phone: +44 (0)114 221 2003

Please complete the checklist in the above section. It is very important to include the HS (Commodity) code 9030.10.00, otherwise import duty may be charged at the UK border, for which you will be liable. Please also include our EORI number GB219670885000 on the commercial invoice.

Please ensure that you make the necessary arrangements with the Customs authority in your territory for the return of your instruments. There may be special procedures for temporary exports. For example, you may need to provide documentary evidence that the instrument was previously imported into your country, to avoid being charged import duty again.

7.4 RAD8 Quality Assurance

While the annual inspection and calibration, carried out by DurrIDGE Company, is the most effective quality assurance, there are other tests and observations that may be made that will give assurance of good performance throughout the year.

7.4.1 Spectrum

The alpha energy spectrum that forms the RAD8's raw data can be viewed in real-time during a test, or at the end of a test, via the Spectrum panel on the Test Status screen. There should be clearly defined peaks and little or no noise across the spectrum. The peaks should be located in the middle of the windows. A clean spectrum is indicative of an instrument in perfect working order, and hence of reliable and accurate readings.

7.4.2 Spill Factor (C Window to B Window)

Due to the occasional alpha particle emitted, from a polonium atom on the detector surface, at grazing incidence to the surface, there is always a small, low-energy tail to the peaks. There is thus a spill of polonium-214 counts from Window C into Window B, normally of around 1% to 1.5%. Similarly, there is a spill of polonium-216 counts from Window B into Window A, and a spill of polonium-212 counts from the D window into the C Window. The actual values are measured during the calibration process (CB Spill for radon calibration, and BA and DC Spill for thoron calibration) and the spill factors used to automatically compensate for this phenomenon. CB Spill only gains relevance in measurements of thoron in the presence of large concentrations of radon. DC and BA Spill are relevant only to measurements of radon in the presence of large concentrations of thoron.

If the detector becomes contaminated in use, or either electronic or detector failure causes noise in the system, thus making the low-energy tail thicker, or the peaks broader, then these spill factors will increase.

The C window to B window spill factor value can be calculated from any reading, provided that it is known for sure that there was no thoron in the chamber. The percentage of counts in windows B and C is indicated on the on-screen histogram. The spill factor is simply the ratio of the values in those two fields.

It is recommended that the C to B spill factor be noted every month. Any sudden change is cause for further study of the instrument, and an examination of the spectrum.

8 TROUBLESHOOTING

8.1 Readings

8.1.1 No Counts

The total number of counts so far in any cycle is displayed in the Summary panel on the Test Status screen. If, near the end of a Cycle, there are no counts, or less than 10, say, it probably means the Cycle length is too short for the low concentration of radon in the sample gas. Increase the Cycle length to increase the number of counts in a Cycle and to improve the precision of the individual readings.

If, with a Cycle Time of one hour or more, the total count near the end of a Cycle continues to be zero and it is known that there is radon in the sample, then either the sample path is blocked or there is a fault with the RAD8 and it should be returned to Durridge Company. Check that air is flowing using any of the following measures:

- a) Feel the air exiting the outlet when the pump is running.
- b) Briefly stop the outlet of the RAD8 and feel the buildup of pressure.
- c) Clamp the sample input tubing, hear the change in pump sound and see the change in pump current.
- d) Feel the suction at the sampling point.

8.1.2 Excessive Uncertainty In Reading

If the uncertainty in the reading is greater than the base concentration value or if there is a large scatter in the readings, the Cycle length is too short for the radon concentration being measured.

Increase the Cycle Time to reduce the scatter. Four times the Cycle Time will produce half the scatter and half the uncertainty. For past data, use Capture to graph the data and use “Smoothing” to smooth out the statistical scatter in the data.

8.2 Relative Humidity High

Relative humidity (displayed in the Summary panel on the Test Status screen) normally starts high unless the instrument has been well purged just before starting the test. Depending on how long it has been since the last measurement, it may take an hour or more of measurement to bring the relative humidity down below 10%.

If it takes too long to bring down the relative humidity, check the following:

- a) The desiccant is used up. Replace it.
- b) The desiccant was insufficiently regenerated. Follow the instructions in Section 7.1.1.

- c) There is a leak in the Laboratory Drying Unit. Clean the O-ring and seating before replacing the desiccant. Be sure to draw the air sample from the bottom end, furthest from the screw cap.
- d) There is a leak in the connection to the RAD8.
- e) There is a blockage in the air path. Squeeze the inlet tubing and note any change in the sound of the pump. Feel for suction at the sampling point.

If none of the above succeed in lowering the relative humidity, there may be a problem with the humidity sensor. Measure the relative humidity of the air leaving the RAD8. If no humidity sensor is available, another RAD8, if one is available, would do. The two RAD8s can be connected in series. Bypass the pump on the downstream RAD8 by using only the Detector In and Sample Out tubing ports. If the downstream RAD8 reads a lower relative humidity than the upstream one, then the upstream humidity sensor is wrong and should be replaced. Return the RAD8 to DurrIDGE Company for service.

If none of these solutions are applicable, measurements made at high humidity can be corrected automatically using DurrIDGE's Capture software (see Section 3.2.5).

8.3 Water Ingress

With its tubing ports unpopulated (closed), and all the protective caps in place over the front panel electrical ports, the RAD8 is completely waterproof. However, if water ever enters the RAD8's sample path it will probably cease to operate and immediate steps should be taken to minimize the impact on the instrument. Keep the RAD8 upright in the briefcase position. This will decrease the risk of water touching the detector. Make sure to hold the RAD8 still to prevent the water from sloshing. Put a piece of tubing on the RAD8 outlet with the other end in a sink. Use the RAD8 pump if it still works or otherwise use an external pump to blow air through the instrument. When water ceases to be blown out of the outlet, put desiccant upstream of the RAD8 to dry out the air path.

Once there is no visible water in or on the instrument, it can be put in an oven at 50°C for a few hours to dry out completely. Additionally, desiccated air can be passed through the air path until the air leaving the RAD8 drops below 10% RH. After this treatment further corrosion will be prevented. If the RAD8 is able to start up, you can use the internal RH sensor to measure how dry the air path is. Regardless of whether the RAD8 is able to operate, at this point the instrument should be returned to DurrIDGE for service.

8.4 Capture RAD8 Detection Failure

If Durridge's Capture software is unable to detect a connected RAD8, the following steps should be taken. Note that comprehensive instructions for troubleshooting a RAD8 detection failure and other Capture problems can be found in the Capture documentation available at the Durridge website, and from the Capture Help Menu.

1. Make sure you are using the latest version of Capture. The software can be downloaded free of charge from the Durridge website.
2. Make sure your computer is running a supported operating system. The supported operating systems are listed in the System Requirements section of the Capture documentation.
3. Make sure the RAD8 is powered On, and that the RAD8's battery is charged or charging.
4. Make sure the RAD8 is connected to the computer properly using a USB Mini-B to USB-A cable.
5. It may be necessary to install driver software on your computer. The drive software is provided on the Durridge website, at <http://durridge.com/software/software-drivers/>.
6. If the RAD8 is not detected when connected to a particular USB port, try connecting it to a different USB port on the computer.
7. Make sure your computer is not running anti-virus software or any program that could interfere with Capture. This includes any other software that communicates using COM ports.
8. After performing the above checks, if the RAD8 is still not recognized, try restarting the RAD8 and your computer. If another computer is available, try to connect the RAD8 to the other computer.

Appendix 1: THERMAL PRINTER

A1.1 Thermal Printer Description

A1.1.1 General Printer Information

A portable printer is offered as an optional accessory for the RAD8. The printer is designed around a patented easy-loading paper mechanism, which consists of a main cavity into which a paper roll is dropped for loading. The thermal print head is at the front of the cavity and a rubber roller is attached to the lid of the mechanism. When the lid is closed, the paper is pinched between the rubber roller and the print-head to give a close alignment and a consistent pressure.

RAD8 Printer Supplies

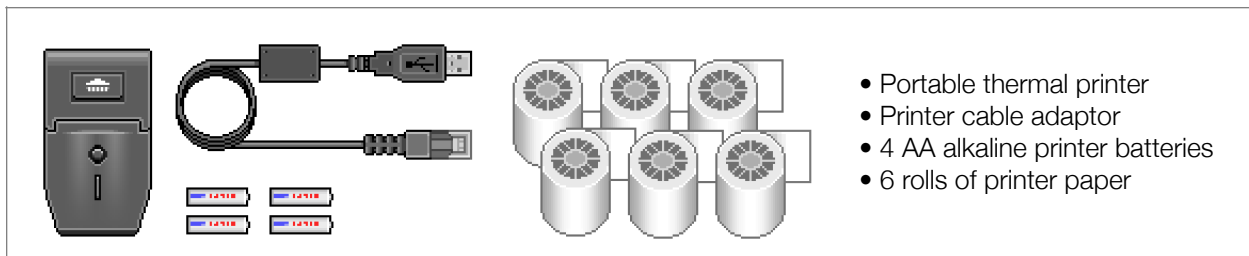

A1.1.2 Printer Features

- Small size
- Quiet and fast printing
- Direct line thermal printing (no ink or toner required)
- Easy loading paper
- Easy maintenance and head cleaning
- User settable parameters using external buttons
- Self-test function

A1.1.3 Power Switch

The Power switch, located on the left side of the printer, is used to turn the unit ON and OFF.

A1.1.4 Indicator LEDs

The Power LED (Green) glows steadily when the printer is turned ON.

The Error LED (Red) flashes once-per-second when the printer is out of paper; the buffer is full; or when the print head temperature exceeds 140°F (60°C). This LED will also flash one time when the printer is placed into its set-up mode (refer to Section Set-Up Mode).

A1.1.5 Push Buttons

FEED Button:

Momentarily press the FEED button to advance the paper. Press and hold down to feed paper continuously.

This button in conjunction with the ON/OFF switch is used to start the printer's self test function (refer to the Self Test section).

When the printer is in its set-up mode, this button is used to modify the selected printer parameter (refer to the Set-Up Mode section).

SEL Button:

Used in conjunction with the ON/OFF switch to place the printer into its set-up mode (refer to the Set-Up Mode section).

With the printer in its set-up mode, use this button to select the desired printer parameter.

A1.1.6 Sensors

Paper Out: When the paper roll becomes empty, the printer is disabled to prevent damage to the print head. This condition is indicated by the Error LED flashing red.

Infrared Sensor: Located at the front of the printer, this sensor receives the infrared output of an external instrument. The RAD8 does not utilize this sensor. Instead, the printer is connected to the RAD8 with the included data cable.

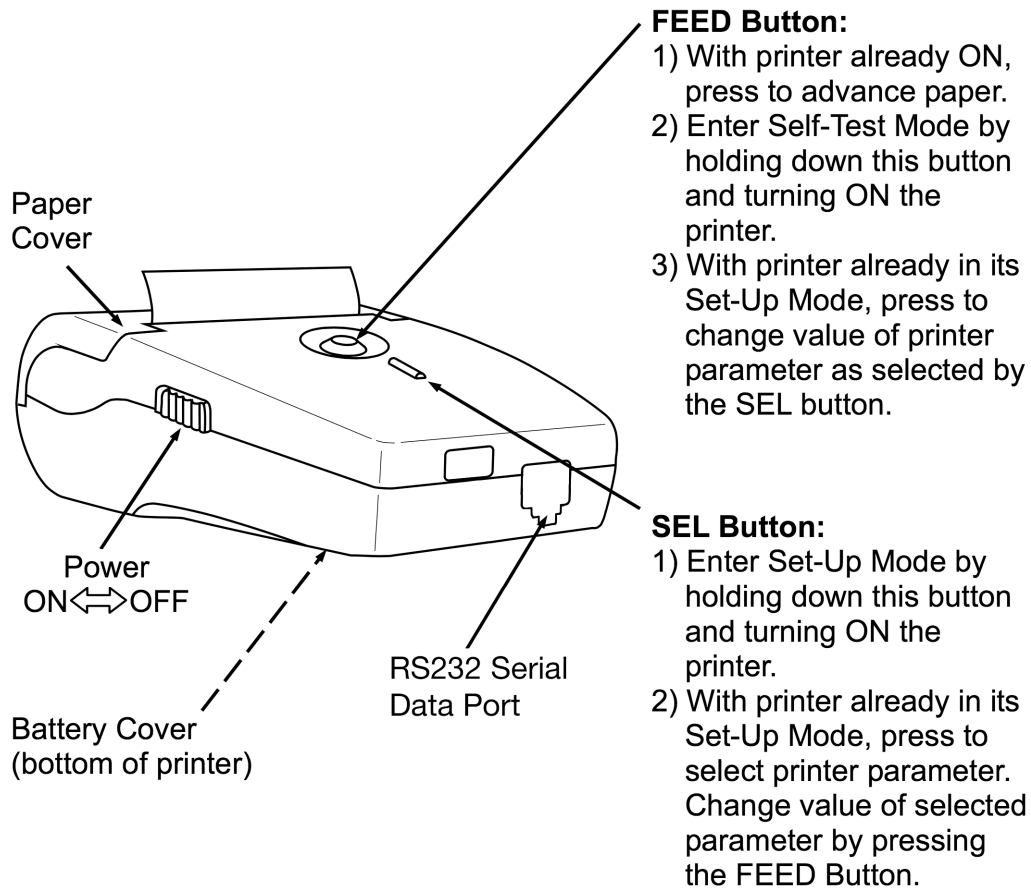

Top View of FEED Button

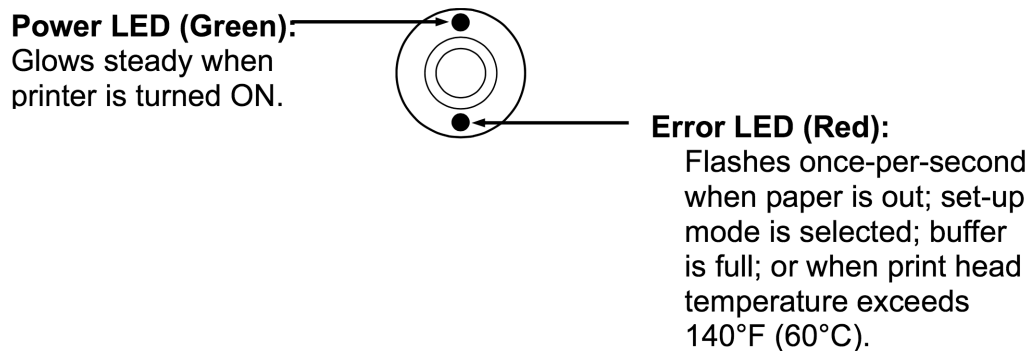

Thermal Printer Component Locations and Functions

A1.2 Thermal Printer Operation

A1.2.1 Precautions

To ensure the proper operation of the printer and prevent the possibility of voiding the warranty, be sure to observe the following precautions:

- Avoid dirty or dusty locations, or those with excessive heat or humidity
- Choose a stable level surface to place the printer
- Use only alkaline batteries
- Use only the appropriate thermal paper

A1.2.2 Self-Test

The self-test mode checks the printer's control circuit functions, setup parameters, software version, and printer quality.

Before conducting the self test, make sure there is sufficient paper (18" [46 cm]); the paper cover is closed; and that the printer is switched OFF.

With the printer initially switched OFF, press and hold down the FEED pushbutton, and then switch ON the printer to begin the test. Note: The test can be aborted by switching OFF the printer.

The following typical information is printed, followed by the printer's complete character set:

```
Version:      x.xx
Data bit:    8 bit
Parity:      None
Baud rate:   9600bps
Handshaking: DTR
Country:    U.S.A.
Print Mode:  Text (upright)
Paper:      Normal paper
Density:    100%
IrDA:       IrDA-SIR
Buffer Size: 7000Byte
Head volt:  6.0V
Head temp.: 25°C
```

A1.2.3 Setup Mode

The printer has been set up at the factory with the following default parameters:

```
Baud rate:   9600bps
Handshaking: DTR
Country:    U.S.A.
Print Mode:  Text (upright)
Paper:      Normal paper
Density:    100%
IrDA:       IrDA-SIR
```

If necessary, the default parameters can be changed as follows:

1. With the printer initially switched OFF, press and hold down the SEL pushbutton; and then switch ON the printer.
2. The printer now goes into its set-up mode as indicated by the red LED flashing. At this time all of the printer's current parameter settings are printed, followed by the first parameter that can be modified.

Note that if no button is pressed within 15 seconds, the set-up mode is automatically terminated without changing the original parameters.

3. IrDA is the first parameter printed. Pressing the FEED button causes the value of that parameter to change in the sequence shown in the following table.

Table A1.2.3 Sel and Feed Functions

SEL Button	FEED Button
Baud Rate	300-115,200 bps
Handshaking	DTR, X-on/X-off
Country	U.S.A., Korea, Cyrillic, Denmark2, Norway, Japanese, Spain, Italy, Sweden, Denmark1, U.K., Germany, France
Print Mode	Text (upright), Data (inverted)
Paper	Normal Paper, Reprint Paper
Density	50-150% in 5% steps
IrDA	IrDA-Off, IrDA-SIR, HP-Ir

4. Press the SEL button to print the next parameter, and then use the FEED button to change that parameter to the desired value.
5. Repeat Step 4 as necessary to change all desired parameters.
6. Once all parameters have been set, press and hold down the SEL button, and then press the FEED button to save the new settings; after which the message "Data Keeping, Setting mode END !!" should be printed.

A1.2.4 Using the Printer

Turn the printer ON and observe that the Power LED should glow green. Connect the printer to the RAD8 with the included data cable. Choose a RAD8 print command to initiate printing.

If the printer does not print, or if random characters are printed, check that the baud rate of the printer is set to the correct value.

To see examples of the printed output that can be generated at the completion of Cycles and Tests, see Section 2.6.4.

A1.3 Thermal Printer Maintenance

A1.3.1 Battery Installation

The printer requires four AA alkaline batteries. To install or replace the batteries, first turn the printer OFF. Next, unlatch and remove the battery cover. Remove any old batteries and dispose of them properly. Then insert four new AA alkaline batteries, observing the polarity marked inside the battery compartment. Finally, replace the battery cover.

A1.3.2 Paper Installation

When the printer runs out of paper as indicated by the front panel red LED flashing, install a new paper roll as follows:

1. Lift up the paper cover latch, and then open the paper cover as illustrated on the following page.
2. Remove the spent paper core and dispose of it.
3. Drop in a new paper roll so that it will rotate in the direction shown in the illustration.
4. Close the paper cover so that the paper is pinched between the roller and the print head. Remove any slack by pulling out about 1/2 inch of paper from the printer.

Note: If there was unprinted data in the memory when the printer ran out of paper, and the printer was not shut OFF, then the printer will automatically print the remaining data 5 seconds after closing the paper cover.

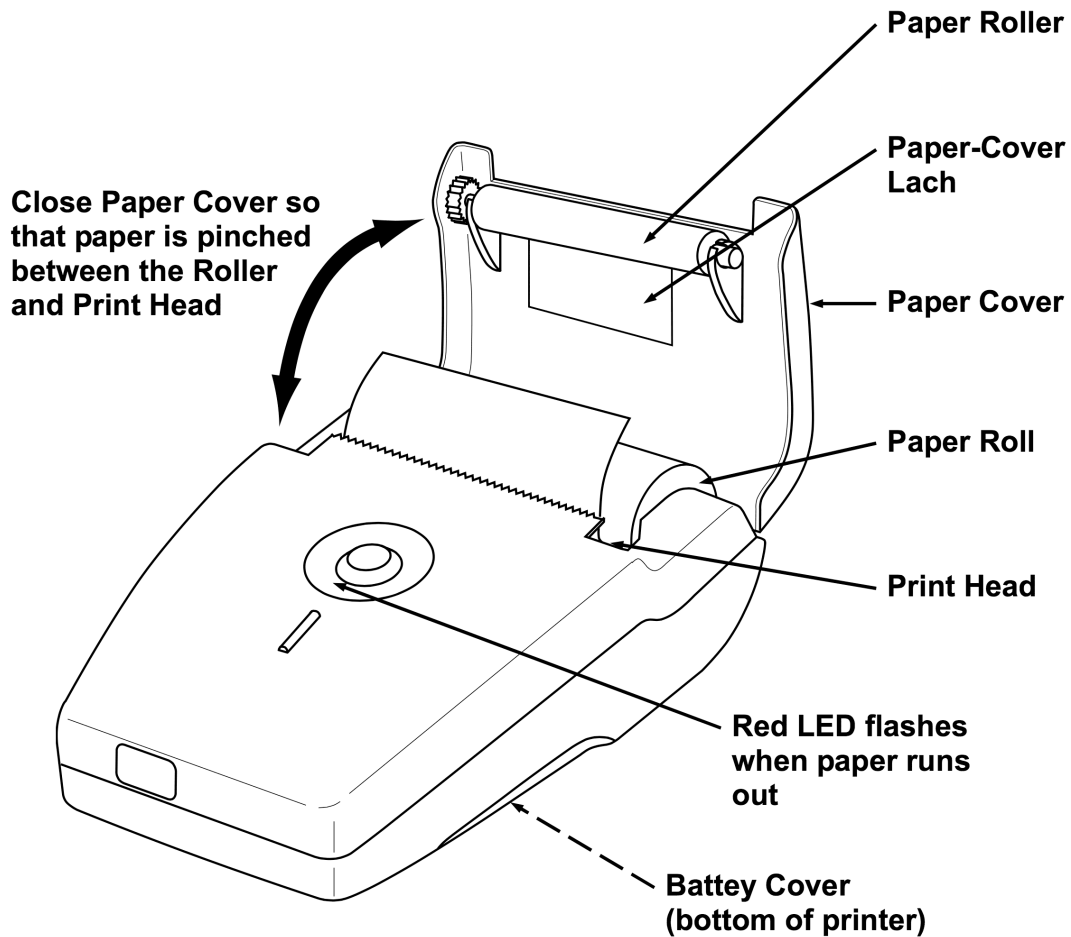

Thermal Printer Maintenance

A1.3.3 Cleaning the Printer

External surfaces of the printer may be kept clean by simply wiping with a damp cloth. Do not use any solvents that may attack the plastic case. Be sure that the inside surfaces are kept dry at all times.

A1.3.4 Cleaning the Print Head

To maintain a good print quality, it is recommended that the print head be cleaned at least once a year or up to once a month if the printer is used heavily. The print head should be cleaned immediately, however, if the print becomes visibly fainter due to contamination of the print head. The cleaning procedure requires isopropyl alcohol and cotton swabs, and should be completed as follows:

1. Switch the printer OFF, and allow the print head to cool before cleaning, otherwise damage to the print head may occur.
2. Open the paper cover and remove the paper roll.

3. Using a cotton swab dampened with alcohol, wipe the heating dots of the print head. Be careful not to touch the heating dots with your fingers.
4. Allow the alcohol to dry.
5. Reload the paper and close the paper cover.

A1.4 Thermal Printer Specifications

The following table contains the physical and technical specifications for the thermal printer. These specifications apply to the Omniprint OM1000 printer and to the Chamjin I&C New Handy printer, model 700-BT. These printers are similar to the now-discontinued HP 82240B printer, except that the HP printer had to have external 12V power supplied in order to stay awake for more than 10 minutes between printouts. The newer printer models run on battery power only.

Table A1.4 Thermal Printer Specifications

Printing Method	Direct thermal
Number of Columns	32, 48 columns, 384 dots/line
Character Size	0.06 x 0.12 in. (1.5 x 3.0 mm)
Line Pitch	0.1 in (4.0 mm)
Paper Type	2.25 in. (57.5 mm). Thermal paper required.
Interface	IrDA and Serial (RS-232C)
Protocol	IrDA-SIR, HP-Ir, IrDA-Off
International Characters	U.S.A., France, U.K., Denmark, Sweden, Italy, Spain, Japan, Norway, Korea
Buffer	7 kB
Baud Rate	300-115,200 bps, IrDA: 9,600-115,200 bps
Power	4 AA Alkaline Batteries
Weight with batteries	0.8 lb. (0.4 kg)
Dimensions	3.2" W x 5.6" L x 1.6" H (81 x 142 x 41mm)

Appendix 2: RAD8 Specifications

The following tables detail the functional, technical, and physical specifications of the RAD8.

Table A2.1 Functional Specifications

Analysis Modes	<ul style="list-style-type: none"> • Rapid: Quick response and rapid recovery radon measurement • Precise: High sensitivity radon measurement • Auto: Automatic switch from Rapid to Precise Analysis Mode after three hours • Radon source options include Air and Water
Thoron Measurement	Built-in Sniff Protocol: Maximum flow rate for enhanced thoron sensitivity
Control Panel	Touchscreen or physical button controls Waterproof and dustproof with case open or closed (IP67)
Data Storage	16 GB storage for millions of records, each with full sensor and spectrum data
Sample Pumping	Built-in pump draws sample from chosen sampling point Flow rate typically 0.6 L/min
Sensors	3 temperature sensors, RH sensor, barometer, accelerometer
Connectivity	Wi-Fi, 2 USB ports, COM port, Accessory port
Audio Output	Multiple audio output options for real-time communication of detection events
Tamper Resistance	Password-protected lock screen secures RAD8 against tampering RAD8 case securable with padlocks

Table A2.2 Technical Specifications

Principle of Operation	Electrostatic collection with silicon detector and alpha spectrometry Rapid Analysis Mode counts ^{218}Po decays Precise Analysis Mode counts both ^{218}Po and ^{214}Po decays
Built-In Air Pump	0.6 L/min flow rate with bypass option for external pumping or flows
Measurement Accuracy	$\pm 5\%$ absolute accuracy, 0% - 100% RH
Nominal Sensitivity	Rapid Analysis Mode, 0.40 cpm/(pCi/L), 0.011 cpm/(Bq/m ³) Precise Analysis Mode, 0.82 cpm/(pCi/L), 0.022 cpm/(Bq/m ³)
Radon Range	0 - 270,000 pCi/L (0 - 10M Bq/m ³)
Intrinsic Background	0.004 pCi/L (0.15 Bq/m ³) or less, for the life of the instrument
Recovery Time	Residual activity in Rapid Analysis Mode drops by factor of 1,000 in 30 minutes
Operating Ranges	Temperature: 0° - 50°C Humidity: 0% - 100%, non-condensing
Cycle Range	User controllable number of Cycles, from 1 to unlimited, per Test User controllable Cycle Time, from 5 minutes to 24 hours
Capture Software	<ul style="list-style-type: none"> • Compatible with all major versions of Windows and macOS • Automatic RAD8 connection, data download, and real-time status monitoring • Graphs radon, thoron, temperature, humidity, and barometric data over time • Automatic correction for humidity and other factors • Statistical analysis tools track concentration averages and uncertainties • Control RAD8 operations from computer via direct or remote connection • Browse RAD8 data stored on Capture Cloud

Table A2.3 Physical Specifications

Dimensions	12.5" x 10.1" x 6" (31.8 x 25.7 x 15.2 cm)
Weight	7.4 pounds (3.35 kg)
LCD Display Output	IPS 480 x 272 full color touchscreen, sunlight readable, wide viewing angle
Case Material	Indestructible, MIL-SPEC certified, IP67
Power Supply	11-15V DC (12V nominal) @ 2A, center pin positive
Battery	Rechargeable lithium ion battery provides 3 days continuous operation

Appendix 3: Glossary of Terms

The following RAD8-related terms appear throughout this manual. It is important for RAD8 users to understand the meanings of these terms.

Term	Definition	See Section(s)
Analysis Mode	The RAD8's Analysis Mode determines which Spectrum Window(s) inform the calculation of radon concentrations. The instrument can operate in either "Rapid" or "Precise" Analysis Mode. With Rapid Analysis Mode, calculations involve Spectrum Window A (the "new radon" window) exclusively, whereas with Precise Analysis Mode calculations involve both Window A and Window C (the "old radon" window). Precise Analysis Mode achieves a factor of 2 higher count rate for a given radon activity concentration, improving statistical precision, but at the cost of a slower response time. Analysis Mode has no impact on how the RAD8 physically operates, leaving the user free to switch between Analysis Modes at any time with no effect on the saved data.	2.3.5 4.9
Capture Software	Durridge's software for Windows and macOS, used to obtain and analyze data from the RAD8, monitor the RAD8 status, and control the RAD8. Capture also provides access to Capture Cloud, which is a cloud-based service for storing, browsing, and sharing RAD8 radon data.	3.2
Concentration	Radon and thoron measurements are recorded as activity concentrations, which may be expressed as Picocuries per liter (pCi/L) or Becquerels per cubic meter (Bq/m ³). Picocurie is the favored unit of radon activity in the U.S., while Becquerel is the favored unit in the rest of the world. 1 pCi/L equals 37 Bq/m ³ .	2.6.1
Cycle	A single RAD8 data reading, which is typically represented as a radon data point on a graph. Cycle lengths are usually between 5 minutes and several hours in duration, as specified by the user. A RAD8 Test consists of a series of Cycles.	1.4.5
Data Slice	An indivisible 5-minute block of RAD8 data. Cycles consist of one or more Data Slices. For example if a Cycle duration is 20 minutes, the Cycle will consist of four 5-minute Data Slices. Each 5-minute period of RAD8 operation normally involves 2 minutes of pump run time, followed by 3 minutes of pump idle time. Data Slices can be recombined using Capture to adjust the spacing between graph data points, to better facilitate data analysis.	5.5.2 5.5.11
ID (Inner Diameter)	An ID specification indicates the inner diameter of a tube. Each tubing connector requires a tube with a particular ID. When measuring thoron, a small ID is desirable, since it increases the speed at which the air sample reaches the RAD8's measurement chamber, minimizing decay in transit.	1.4.1 1.5
Live	When the RAD8 is Live it is conducting a Test and recording data. When the RAD8 is not conducting a Test it is Idle .	2.4

Protocol	A RAD8 Protocol is a specific combination of Test parameters, determining the Test duration, pump behavior, and other Test attributes. The RAD8 contains several built-in Protocols, and it is also possible to create custom User Protocols.	2.3.2
Run	Synonymous with Test (as described below), but used exclusively in reference to RAD7 data, not RAD8 data.	N/A
Sensitivity	The RAD8's responsiveness to radon and thoron, typically denoted in counts per minute per picocurie per liter, which is abbreviated as cpm/(pCi/L). A higher sensitivity allows the RAD8 to achieve a statistically meaningful measurement more rapidly. Each RAD8 is programmed with separate sensitivity figures for Rapid and Precise Analysis Modes, as determined by radon calibration. By default, thoron sensitivity is set to a fixed fraction of Rapid Analysis Mode sensitivity. For a small extra fee, Durrige can perform a dedicated thoron calibration using uncertified calibration materials, and program the RAD8 with the measured sensitivity.	4.5.1
Spectrum	The RAD8 detects radon by registering the energies of alpha particles emitted through the decay of radon progeny that have been produced inside the measurement chamber from the decay of radon. These energies populate a scale called the Spectrum. The Spectrum is depicted as a histogram ranging from 0 MeV to 10 MeV, and it typically contains prominent peaks representing the accumulation of radon and thoron detection events.	4.6
Spectrum Window	The spectrum peaks described above appear in four consecutive segments of the spectrum energy scale, which are called the A, B, C, and D Windows. These represent new radon, new thoron, old radon, and old thoron, respectively. If, for example, a peak forms in the B Window, it is evident that the RAD8 has detected new thoron.	4.7
Spill Factor	The portion of a spectrum peak that occupies a neighboring spectrum window. For example, a small percentage of the total counts in the C Window peak fall in a low-energy tail that extends downward into the B Window. Likewise, the tail of the B Window peak extends downward slightly into the A Window, and the tail of the D Window peak extends downward slightly into the C Window. We call these the CB, BA, and DC Spill Factors, respectively. These phenomena are accounted for automatically by the RAD8 firmware when calculating reported radon and thoron concentrations.	4.5.1 5.5.3 7.4.2
Test	A RAD8 Test consists of all the data that is recorded between the time the instrument is started and when it is stopped. A test consists of multiple Cycles, each of which may be between 5 minutes and several hours in duration.	1.4.5
Uncertainty	When the RAD8 reports radon and thoron concentrations, the concentration value is accompanied by an additional value indicating the 2-sigma ($k=2$) <i>statistical</i> uncertainty (as distinguished from <i>systematic</i> uncertainty). This is based on a 95% confidence interval, meaning the true concentration will fall within the specified uncertainty range 95% of the time. Large uncertainty values are often the product of the fact that it is impossible to measure low radon concentrations quickly. This can be avoided by increasing the Cycle Time.	1.5 4.11.3 8.2.2

For Sales & Service Contact

geotech

2650 E. 40th Ave. • Denver, CO 80205
Phone 303-320-4764 • Fax 303-322-7242

1-800-833-7958

www.geotechenv.com

© Copyright 2022 Durrige Company Inc. All rights reserved.

Durrige, the Durrige logo, and the Works with the Durrige logo are trademarks of Durrige Company Inc., registered in the U.S.

Note: Durrige frequently updates its product manuals with new information. The latest version of this manual can be downloaded in PDF format from the following location:
<http://durrige.com/support/product-manuals/>

Revision 2022-12-14