



FROG-5000™

Chemical Analysis System



User's Manual

Defiant Technologies, Inc.

2018 Rev.3

How to assemble a ferrule.

This problem has arisen so often and caused so many problems, that we have added it as a preface to the manual. There is a Teflon ferrule where the air sampler and glass sparge bottle mounts to the FROG-5000™. At some point, the ferrule will probably be disassembled and if it is re-assembled incorrectly, there will be a leak in the system. The photograph below shows the proper orientation of the ferrule components:



We hope that this helps you achieve the full degree of enjoyment our instrument can provide.

Sincerely, Defiant Tech

FROG-5000™
Chemical Analysis System
User's Manual

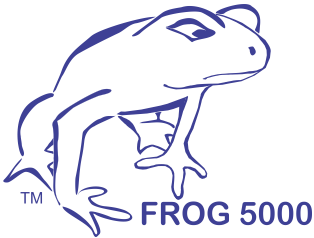

Defiant Technologies, Inc.
2018 Rev. 3
www.defiant-tech.com



HANDLING INSTRUCTIONS

FROG-5000™ is a robust, portable instrument, which can be operated in a lab setting or in the field. This instrument can be damaged if the unit is mishandled. The following precautions are given to ensure correct handling of the instrument.

PRECAUTIONS

- DO NOT** invert with water in the sparge bottle.
 System can NOT analyze a water or soil sample when inverted!
 Damage to instrument is possible!
 (If this does occur, the system may require maintenance. Refer to Section 8, Trouble Shooting)
- DO NOT** handle or carry system when water sample is being analyzed. For the best results, limit movement to before or after sample analysis.
- DO NOT** transport or store the instrument with liquid in the sparge bottle.

When there is Water in the Sparge Bottle

Do **NOT** invert 90° Angle Do **NOT** invert 180° Angle





This page is intentionally
left blank.

TABLE OF CONTENTS

Handling Instructions	5
Commonly Used Acronyms	9
Section 1: Getting to Know the FROG-5000™	11
1.1 Manual Overview	11
1.2 Operations Overview	12
Section 2: Components and Systems	15
2.1 Instrument Components.....	16
2.2 Purge and Trap System	20
2.2.1 Load/Analyze Valve	22
2.2.2 Sparge Bottle Positions	23
2.3 Gas Phase Analysis System.....	24
2.4 Gas Sample Analysis Flow Diagrams	27
2.4.1 Sample Loading	27
2.4.2 Sparge and Collection.....	28
2.4.3 Release, Separation and Analysis	29
2.5 Gas Sampling Analysis Flow Diagrams Air Sampler.....	30
2.5.1 Sample Collection.....	30
2.5.2 Release, Separation and Analysis.....	31
Section 3: Overview of Ellvin™ Chromatography Software	32
Section 4: Field and Lab Analysis Procedures	33
4.1 Powering On/Charging the Battery	37
4.2 Connecting to Computer/Ellvin™	41
4.3 Instrument Settings	45
4.4 Instrument Preparation	49
4.4.1 Rinsing the Instrument.....	49
4.4.2 Creating a Clean Baseline	50
4.4.3 Connecting the Air Sample Adaptor.....	53
4.5 Loading a Sample.....	57
4.6 Running a Sample	61
4.7 Importing Data to Ellvin™	67

TABLE OF CONTENTS CONTINUED

Section 5: Ellvin™ Chromatography Software	73
5.1 Features of Ellvin™	74
5.2 Applying Ellvin™ Features	80
5.2.1 OPEN Button	80
5.2.2 Magnifying Glass	82
5.2.3 Integrator	84
Section 6: Calibration	91
6.1 Calibration Standards	92
6.1.1 Standards for Liquid or Soil Samples	92
6.1.2 Standards for Air Samples	94
6.2 Ellvin™ Calibration Window Features	97
6.2.1 List of Analytes	97
6.2.2 Correlation Chart and Equations	99
6.3 Calibration Procedure	100
Section 7: Maintenance	109
7.1 Routine Cleaning	109
7.2 Cleaning the Scrubber	110
Section 8: Trouble Shooting	115
8.1 Inverting the FROG with Water in the Sparge Bottle	115
8.2 Degrading Chromatograph: Scrubber is NOT secured properly	119
8.3 Cannot Achieve a Clean Baseline	120
8.4 Cool Features (Continuous Operation)	122
8.5 Really Useful Features	123
9.1 Care for the Li-Po Battery	124
10.1 Repositioning the sparge nut cover	125
Appendix I: Accessories/Spare Parts	127
Appendix II: Detectable Chemicals	133

COMMONLY USED ACRONYMS

PC: Preconcentrator

PID: Photo Ionization Detector

GC: Gas Chromatography

VOCs: Volatile Organic Compounds

BTEX: Benzene, Toluene, Ethylbenzene, Xylenes

Ellvin™: Defiant's Chromatography Software



FROG-5000™



This page is intentionally
left blank.

SECTION 1: GETTING TO KNOW THE FROG-5000™

1.1 MANUAL OVERVIEW

The FROG-5000™ uses a practical approach to instrument set-up and operations. This manual includes the following:

- An overview of the FROG-5000™ operational systems, components, and features.
- Diagrams illustrating the flow of a sample during loading, sparge, collection and analysis.
- Instructions for using the chromatography software (Elvin™).
- Detailed procedures for using the FROG-5000™.
- Instructions for calibrating the instrument.
- Routine maintenance information.
- Troubleshooting information.

1.2 OPERATIONS OVERVIEW

The FROG-5000™ instrument analyzes air, water or soil to identify volatile organic compounds (VOCs) present in a sample and determines their concentrations.

The instrument is designed to operate either in the field or in a laboratory, and either connected or not connected to a computer running the Ellvin™ Software. Data is stored on the user's hard drive when the FROG is attached to a computer. Data is also stored on the FROG's internal memory card and can be imported to a computer later.

The FROG-5000™ has a 5 mL sparge bottle that can be used for water or solid samples. It is good practice to keep the total volume in the sparge bottle at a constant 5 mL. For instance, if the user wishes to dilute a water sample 10 to 1, a sample volume of 0.5 mL would be diluted with 4.5 mL of clean water, resulting in a total volume of 5 mL.

If analyzing soil samples, the user must add water to the sparger to ensure that the sample is appropriately agitated.

The basic steps for operating the system are:

1. Adjust/apply the settings as needed.
2. Ensure that the instrument displays a clean baseline.
3. Load a 5 mL sample.
4. Run an analysis, either connected or not connected to Ellvin™.
5. If not connected to Ellvin during the analysis cycle, read analysis data using Ellvin at a later time.

NOTE: A working knowledge of Ellvin™ is necessary to correctly operate the instrument. Users should be familiar with the software before attempting to analyze samples.



The FROG-5000™ is designed for use in the field.

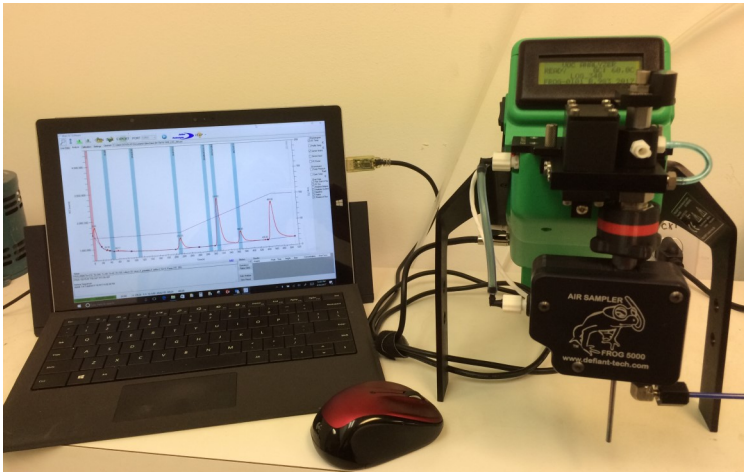

The FROG-5000™ is designed for use in the laboratory. Connect to Ellvin™ Software for more detailed analysis results.



This page is intentionally
left blank.

SECTION 2: COMPONENTS AND SYSTEMS

The FROG-5000™ instrument has two main operational systems:

The Purge System

This system manages the loading of a sample, sparging the sample, if liquid, to release VOCs, and the introduction of gas phase compounds to the Gas Phase Analysis System. All components of the Purge System are visible on the instrument exterior.

The Gas Phase Analysis System

The Gas Phase Analysis System receives the VOCs from the Purge System and carries them through all stages of sample analysis, Collection → Injection → Separation → Detection

The instrument's components are briefly described on the following pages.

Section 2: Components and Systems Continued

2.1. INSTRUMENT COMPONENTS

Components Reference for FROG-5000™:

- A. Scrubber
- B. Load/Analyze Valve Handle
- C. Display Screen
- D. Sparge-Air Line
- E. Sparge-Valve
- F. Flow Selection-Valve
- G. Sparge Manifold
- H. Pump Vent Orifice
- I. Pump Air Supply Inlet
- J. Sample Inlet
- K. Sparge Bottle with PEEK Tube (i.e., sparge needle)
- L. Sparge Bottle Nut
- M. 5 mL Syringe to load water sample

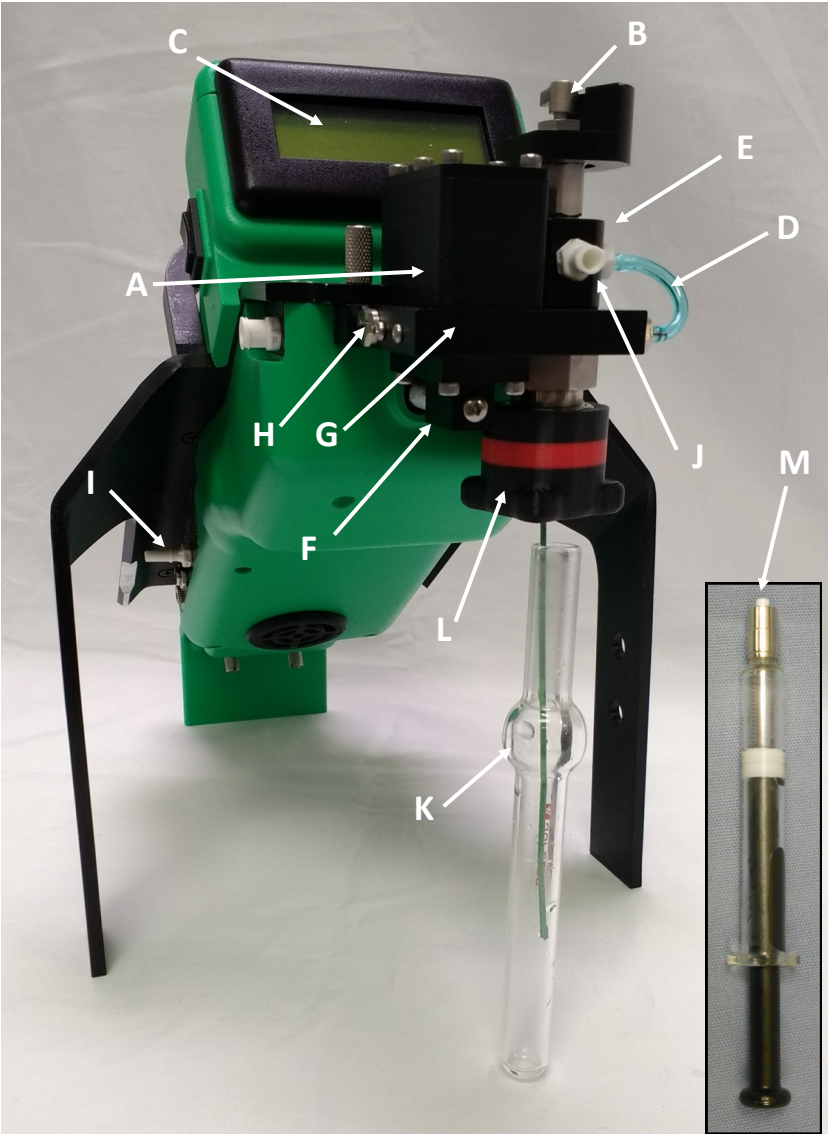

2.1. Instrument Components Continued

- N. micro-SD Card for stored chromatograms
- O. Run Start and Data Toggle Switch
- P. Port for Serial Data Plug
- Q. Port for 12VDC Power Plug
- R. Port for Pump Intake for Carrier/Spurge Gas
- S. Battery Cover
- T. Power Port for Air Sampler Adapter
- U. Exhaust Port from Gas Analysis Module
- V. Power Switch
- W. Battery Charging Light
- X. Battery Charge Level Indicator

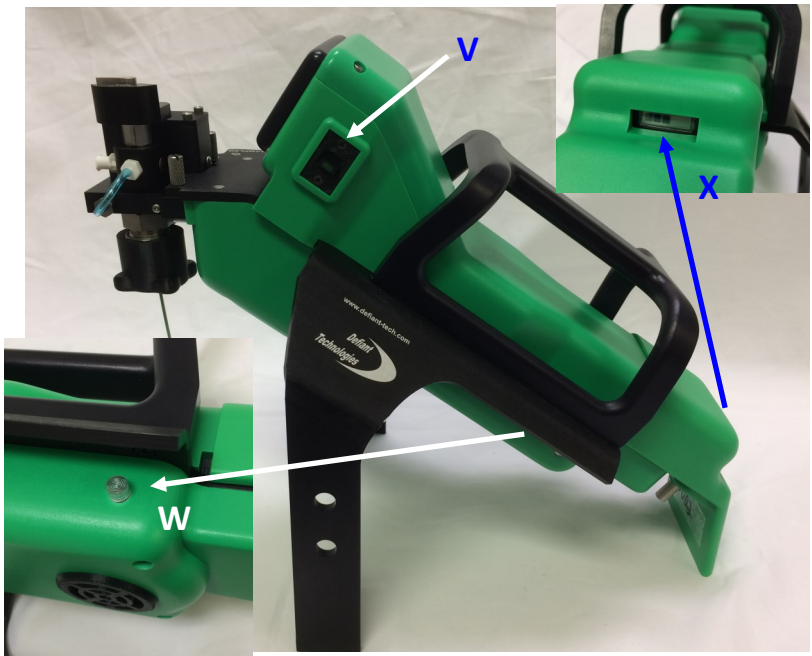
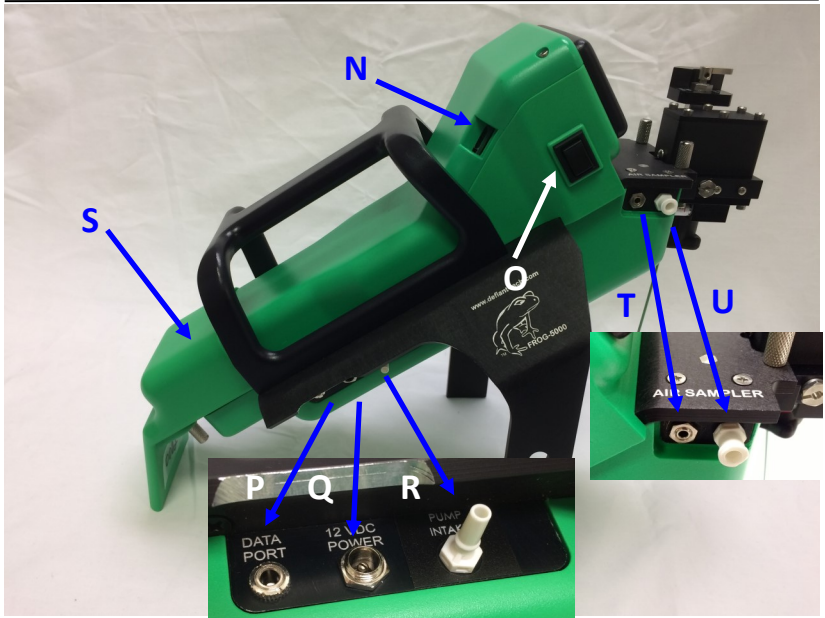

Section 2: Systems and Components Continued

2.2. PURGE SYSTEM

Purge System Components and their Functions

Figures 2.2-1 and 2.2-2.

- A) Scrubber:** Activated Carbon and Molecular Sieves
Function: Cleans the ambient air to prevent external VOCs from interfering in analyses.
*See NOTE on following pages for replacement supplies.
- B) Load/Analyze Valve:**
Function: Opens and closes the sample inlet for sample loading. The valve has three positions, LOAD WATER, RUN WATER and RUN AIR.
- E) Sparge-Valve:**
Function: Directs pumped air from purging water to analysis.
- G) Sparge Manifold:**
Function: Routes gas to the proper ports for sparging and analysis functions.
- J) Water Sample Inlet:**
Function: Attachment for syringe to load a sample.
- K) Sparge Bottle with PEEK Tube:** Needle type sparge bottle, 0.5" x 5mL.
Function: Holds sample to purge VOCs. The Sparge bottle has two positions, UP and DOWN.
(See Section 2.2.2 for operating instructions)
- L) Sparge Bottle Nut:**
Function: Holds Sparge bottle in place and provides gas tight seal.
- M) Syringe:** 5mL, with Luer Lock.
Function: Loads a fixed sample volume to the sparger. Attaches to sample inlet (J).

Figure 2.2-1: Purge and Trap System

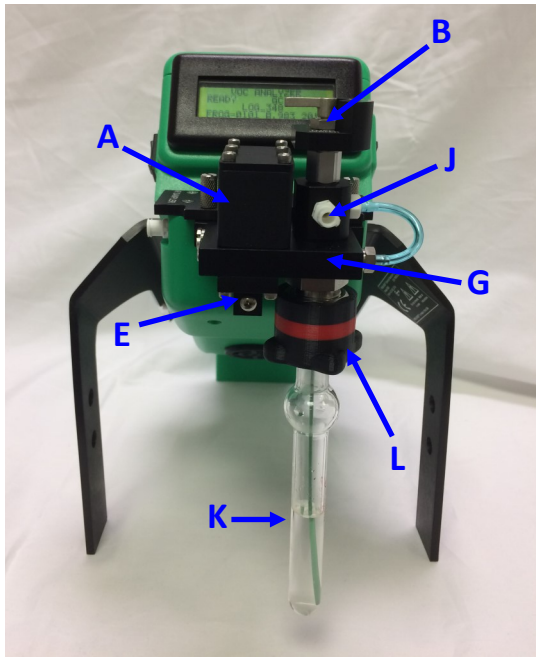
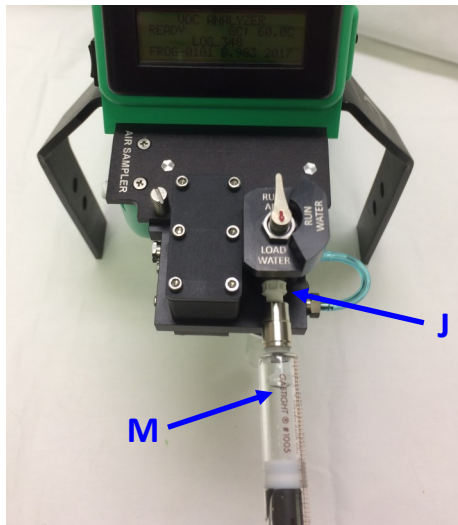

Figure 2.2-2: Purge System



2.2 Purge and Trap System Continued

2.2.1. LOAD/ANALYZE VALVE

- Turn the load/analyze valve to the LOAD WATER position to load a water sample.



- After loading a water sample, turn the handle counter clockwise to the RUN WATER position before starting a water analysis cycle.



- When running air samples, leave the load/analyze valve in the RUN AIR position

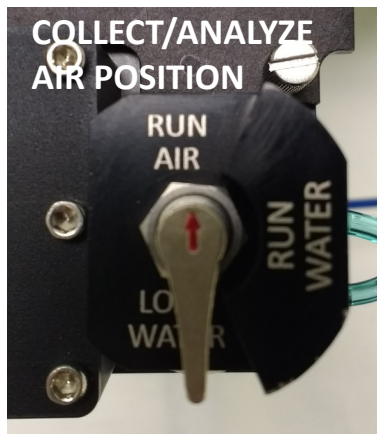

2.2.2. SPARGE BOTTLE POSITIONS

The sparge bottle moves UP and DOWN and is secured with a sparge bottle nut.

- The bottle must be in the DOWN position to rinse the instrument or to remove the sparge bottle.
- The bottle must be in the UP position to analyze a sample.
- The bottle may be in the UP or DOWN position for sample loading. We will present the DOWN position for consistency in this manual.

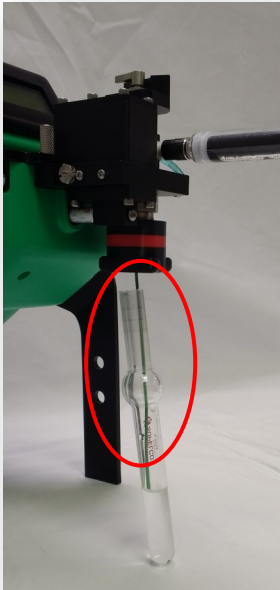

Sparge bottle
in the DOWN position.

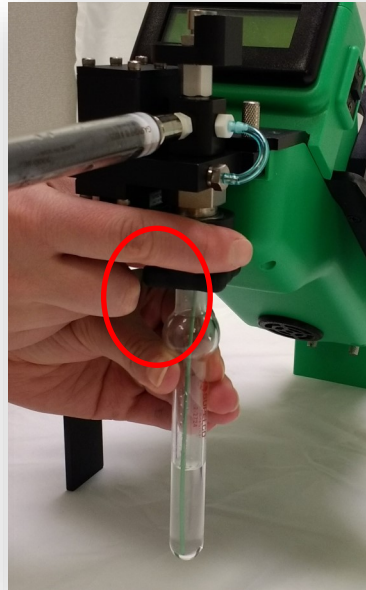

Sparge bottle
in the UP position.

NOTE: When the sparge bottle is fully UP, the sparge tube is near the bottom of the sparge bottle. A partially lowered sparge bottle will cause analyte peaks to shift right.

Section 2: Components and Systems Continued

2.3. GAS PHASE ANALYSIS SYSTEM

Gas Phase Analysis System Components and their Functions

Figures 2.3-1 and 2.3-2:

A-Internal) Pump: Diaphragm pump

Function: Circulates carrier gas through system.

B-Internal) Preconcentrator (PC):

Function: Collects and injects VOCs into GC column.

C-Internal) Micro Gas Chromatography Column: (GC)

Function: Separates VOCs.

D-Internal) Photo Ionization Detector (PID): 10.6eV lamp

Function: Detects VOCs.

E) Sparge-Valve:

Function: Directs pump flow into sparge bottle to purge VOCs from sample.

F -Internal) Bypass-Valve:

Function: Allows the VOCs to pass over the PC and bypass the GC and PID.

G) Pump Vent Orifice:

Function: Provides a small leak in pump flow for improved flow control.

H-Internal) Injection Split Vent:

Function: Provides a small leak to prevent rebound injection.

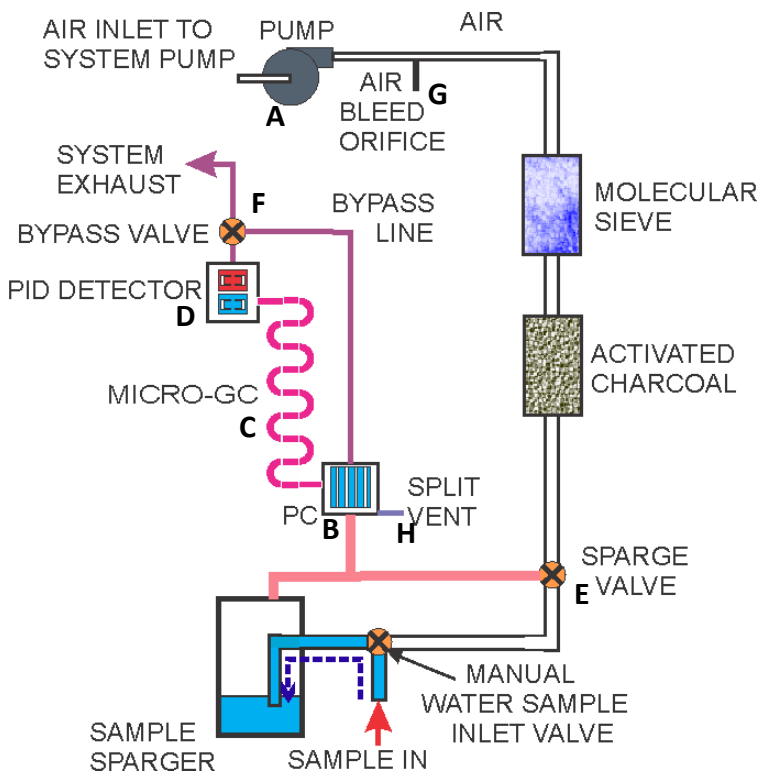

Figure 2.3-1 Gas Phase Analysis System components.

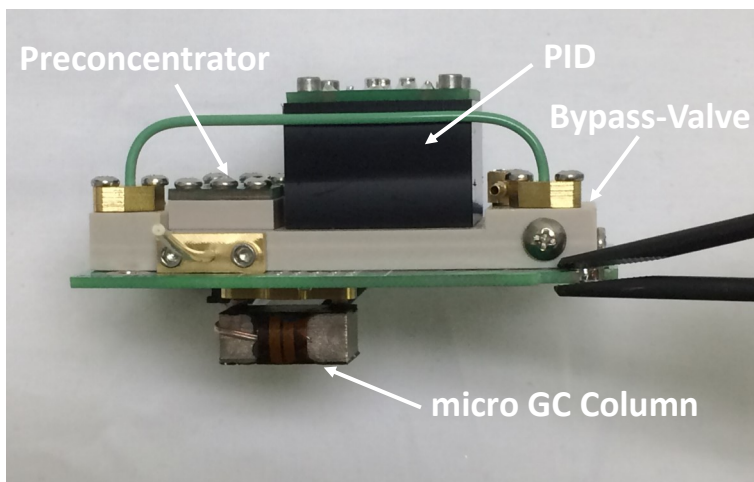

Figure 2.3-2 Gas Phase Analysis System internal components.



2.3. Gas Phase Analysis System Continued

Gas Phase Analysis System Components and their Functions
 Figure 2.3-3

Gas/Purge System, An Internal View. Analytes that are sparged from water samples exit through a port at the top of the sparge bottle and move through the transfer line to the Gas Analysis System

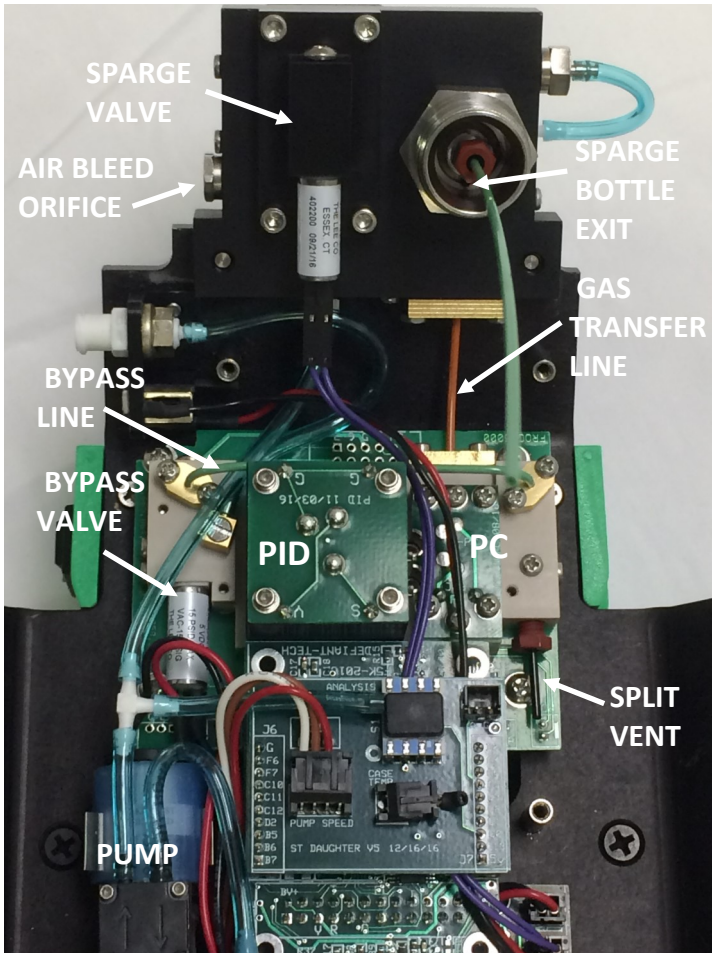

Figure 2.3-3 Gas Phase Analysis System internal and external components

Section 2: Systems and Components Continued

2.4. GAS FLOW DIAGRAMS

This section describes and illustrates the flow of a sample from loading through the components of the Gas Phase Analysis System (Section 2.2).

2.4.1. SAMPLE LOADING

(Diagram 2.4-1) The sparge bottle is in the DOWN position for loading a liquid sample. The load/analyze valve is in the LOAD position. A sample is loaded into the sample inlet with a 5mL syringe.

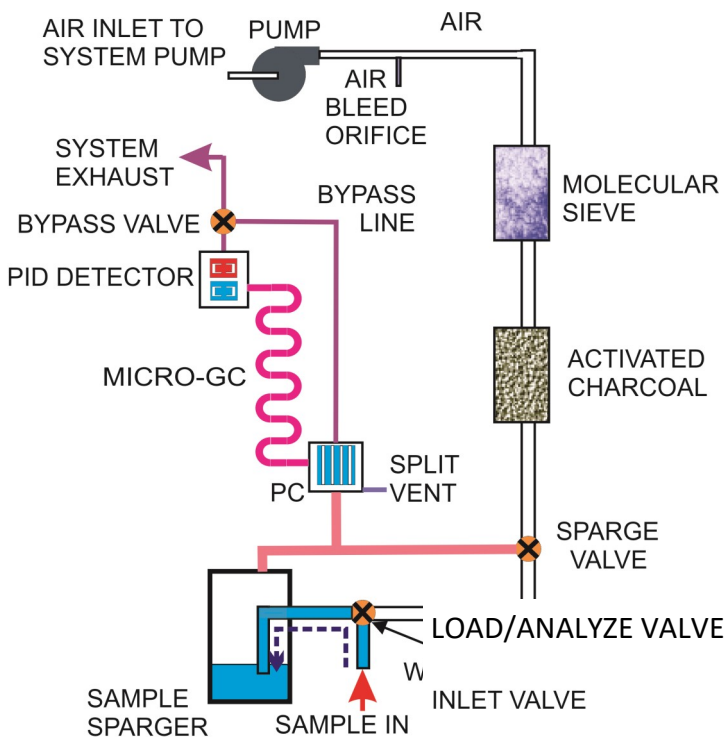

FLOW DIAGRAM FOR FROG 5000 H2O LOAD

Diagram 2.4-1: Sample Loading



2.4.2. SPARGE AND COLLECTION

(Diagram 2.4-2) After the sample has been loaded, the load/analyze-valve is placed in the RUN WATER position, and the sparge bottle is moved into the UP position. The start button is pressed, and the pump flow starts. The carrier gas moves through: 1) the activated charcoal/molecular sieve scrubbers then to the 2) sparge valve. If the sample is a liquid, scrubbed air sparges the liquid to release the VOCs into the headspace of the sparge bottle, through the gas transfer line and onto the preconcentrator (PC). The scrubbed air continues past the PC and out of the system exhaust.

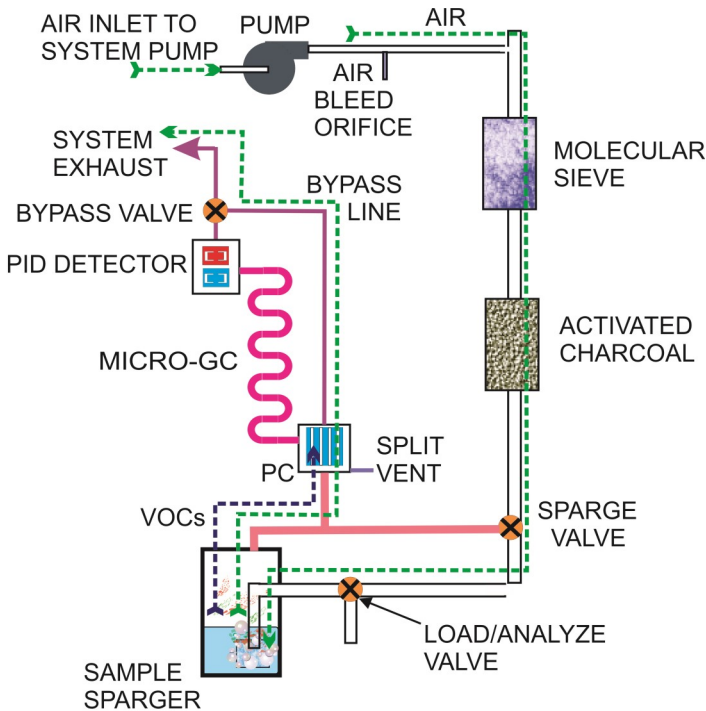

FLOW DIAGRAM FOR FROG 5000 H2O SPARGE

Diagram 2.3-2: Sparge and Collection

2.4.3. INJECTION (RELEASE), SEPARATION, AND ANALYSIS

(Diagram 2.4-3) Once the VOCs are collected onto the PC, the PC is heated to release the VOCs and inject them into the Micro-Gas Chromatograph Column (GC). The VOCs separate through the column and then continue to the Photo Ionization Detector (PID). The PID signal is analyzed and displayed through the software. The sample then exits through the exhaust.

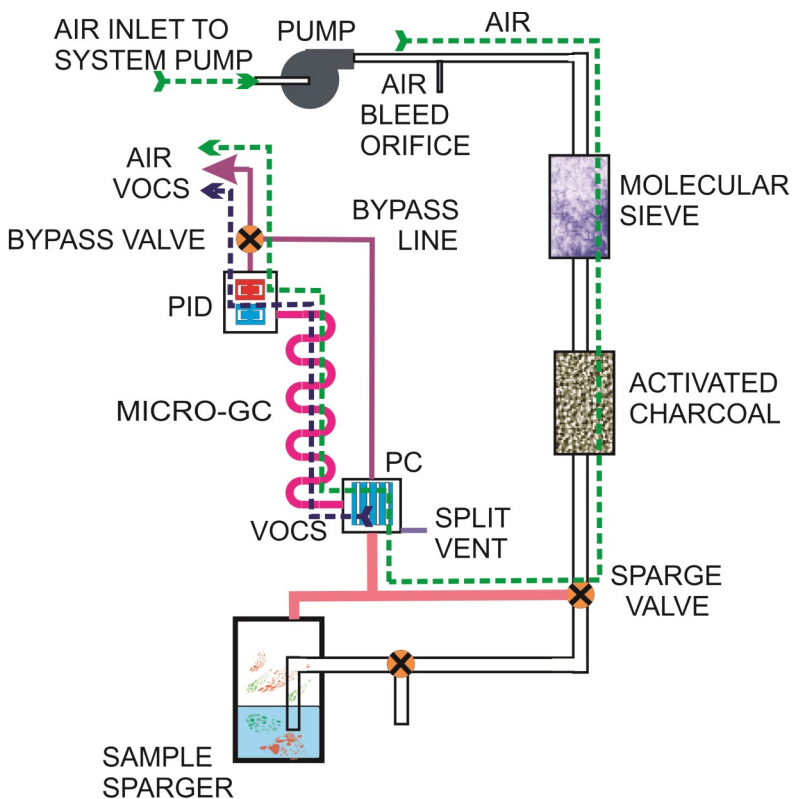

FLOW DIAGRAM FOR FROG 5000 H2O ANALYZE

Diagram 2.4-3: Injection, Separation and Analysis

Section 2: Systems and Components Continued

2.5. GAS FLOW DIAGRAMS THROUGH AIR SAMPLER

This section describes the flow of an air sample when it is loading into the Gas Phase Analysis System using the air sampler (see Section 4.4.3).

2.5.1. SAMPLE COLLECTION

(Diagram 2.5-1) The air sampler is connected to the FROG-5000. The start button is pressed and sample collection starts. Sample gas moves through: 1) an inert valve in the air sampler 2) over the preconcentrator, and 3) out of the gas module. A pump in the air sample adapter provides vacuum for pulling the air sample over the preconcentrator.

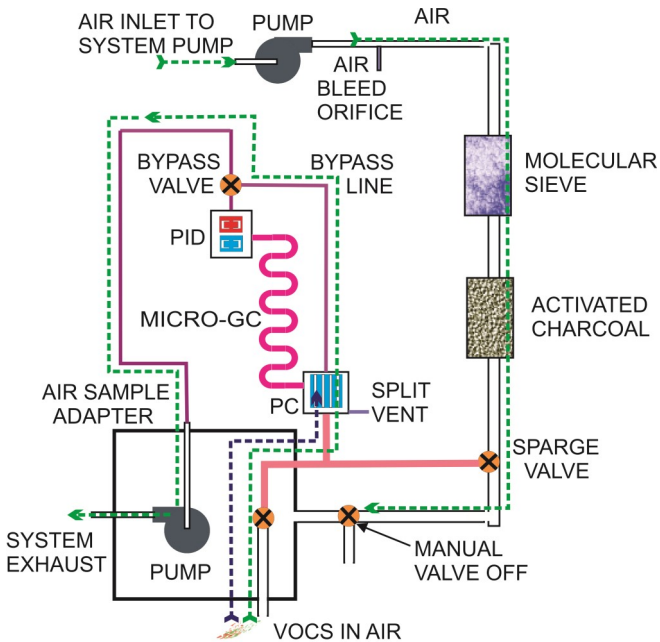

FLOW DIAGRAM FOR FROG 5000 AIR COLLECT

Diagram 2.5-1: Sample Collection

2.5. Gas Flow Diagram Continued

2.5.2. INJECTION (RELEASE), SEPARATION, AND ANALYSIS

(Diagram 2.5-2) Once the VOCs are collected onto the PC, the PC is heated to release the VOCs and inject them into the Micro-Gas Chromatograph Column (GC). The VOCs separate through the column and then continue to the Photo Ionization Detector (PID). The PID signal is measured and displayed through the software. The sample exits through the exhaust.

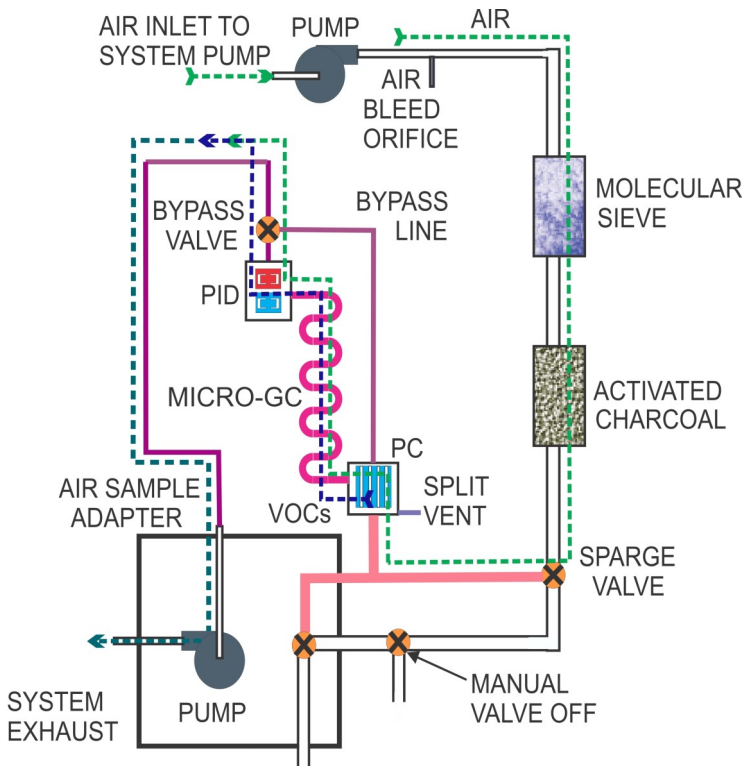

FLOW DIAGRAM FOR FROG 5000 AIR ANALYSIS

Diagram 2.5-2: Injection, Separation and Analysis



SECTION 3: OVERVIEW OF ELLVIN™ SOFTWARE

The Ellvin™ Software has four windows that are accessed with tabs when the software is open.



Window Tabs in Ellvin™

- **Live Data Window:** This is the default window for Ellvin™. In Live Data Window, Ellvin™ creates a chromatogram from sample analysis data. The data source may be:
 - a. From a sample loaded and simultaneously analyzed by Ellvin™.
 - b. From sample data previously recorded on the instrument's SD card, then imported to Ellvin™.
- **Analyze Window:** In this window, Ellvin™ retrieves analysis data that was previously stored on a computer and creates a chromatogram. In the Analyze Window, the user can examine chromatograms closely, integrate chromatogram peaks, and export data to Excel.
- **Calibration Window:** In this window, Ellvin™ uses analysis data from chemical standards to create a FROG calibration file.
- **Settings Window:** In this window, Ellvin™ manages the settings for operation of the FROG. The settings define temperature and duration parameters for various phases of the instrument's collection and analysis cycle.

There are several general features of Ellvin™ as well as a few features specific to Analyze Window that are described in Section 5. The user should be familiar with all the features before starting a sample analysis.

SECTION 4: FIELD AND LAB ANALYSIS PROCEDURES

The simplest way to use the FROG is to load samples and run analyses while the instrument is connected to a computer and Ellvin™. The software analyzes sample data and displays a live chromatogram during analyses. The length of the cycle depends on the parameters set for each analysis. Data is stored both on the FROG's internal SD card and on the computer.

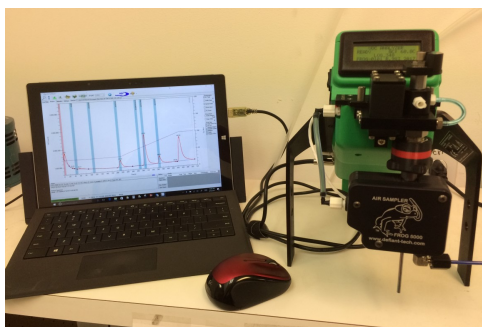

The FROG can also analyze samples when not connected to Ellvin™. An analysis cycle takes the same amount of time as it does when it's connected, and an estimate of the results is displayed on the instrument's screen. Data is stored on the FROG's internal SD card and can be imported to Ellvin™ and analyzed at a later time if desired. Section 4.7. gives instructions for importing data from the FROG.

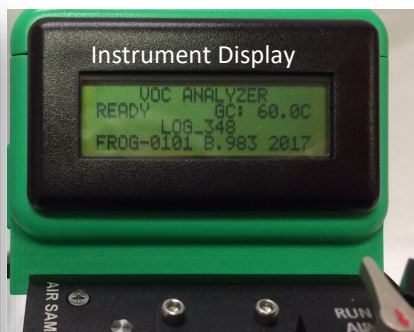

Continued next page.

Section 4: Field and Lab Analysis Procedures Continued

This section provides detailed instruction for various procedures that are essential to operating the FROG-5000™.

Procedures include:

4.1: Powering On/Charging Battery

Description of components and connections.

4.2: Connecting to Computer/Ellvin™

Instructions/description for components and connections.

4.3: Instrument Settings

Set parameters to optimize instrument function.

4.4: Instrument Preparation

Remove interfering contaminants/ensure a clean instrument.

4.5: Loading a Sample

Air, liquid, and soil sample preparation and loading instructions.

4.6: Running A Sample

Instructions/description for an analysis cycle.

4.7: Importing Data to Ellvin™

Import stored data from FROG to Ellvin for analysis.

Complete the following procedures to run an analysis.

NOTE: The user should be familiar with Ellvin™ before loading and running an analysis. To help meet this need, some handy Quick Start guides are provided with the system.

1. **4.1: Powering On/Charging Battery**

2. **4.4: Instrument Preparation**

3. **4.5: Loading a Sample**

4. **4.6: Running A Sample**

If not connected to Ellvin,

5. **4.7: Importing Data to Ellvin™**

6. Clean the instrument when all samples have been completed by repeating Step 2.

4.4: Instrument Preparation

Exception: Samples of the same, known analyte may be run consecutively from low concentration to high without rinsing the instrument and creating a clean baseline.



This page is intentionally
left blank.

Section 4: Field and Lab Analysis Procedures Continued

4.1: Powering On/Charging Battery

Powering On

- Connect power cable to power port (R) 12V POWER, or use battery power. (Figure 4.1-1)
- Turn power switch (O) to ON (fully up) position. The instrument display screen will be visible.

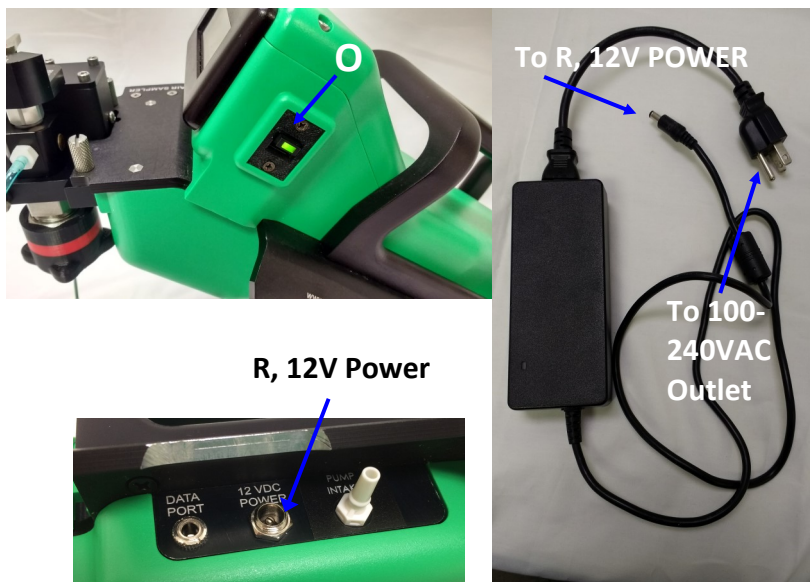
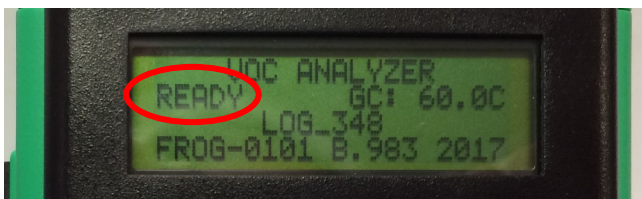

Figure 4.1-1: Power port, power cable and power switch.

- When the FROG-5000™ display screen shows **READY**, the instrument is ready to perform an analysis.



4.1. Powering On/Charging Battery Continued

Charging the Battery

1. Plug 12 VDC power supply into 12VDC POWER port.
2. The battery recharges while the unit is plugged into external power.
3. Blue light shows power is supplied.
4. Flashing green light indicates battery is charging.
5. Unit may be operated while charging.

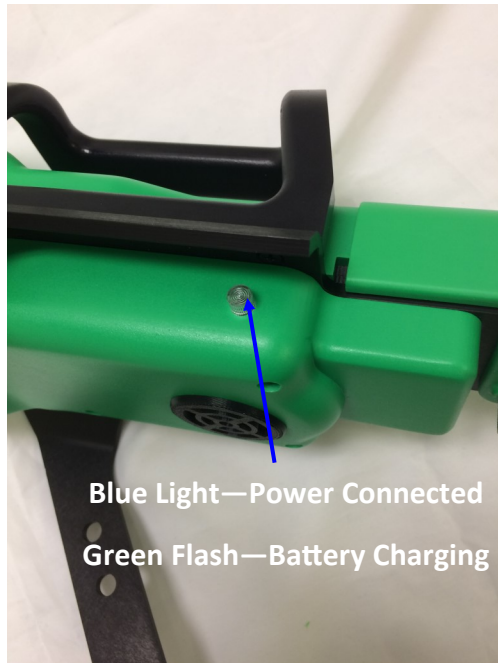

This page is intentionally
left blank.

Section 4: Field and Lab Analysis Procedures Continued

4.2: Connecting to Computer/Ellvin™

There are two possible connections between the FROG and a computer.

To receive live data and communicate with the FROG through Ellvin™, connect a computer to the serial data port (Q) on the FROG with the USB-to-Serial-Data Cable.

To import data from the instrument's micro-SD card (N), press in to eject the card. An adapter is provided to plug the card into a USB port on a computer.

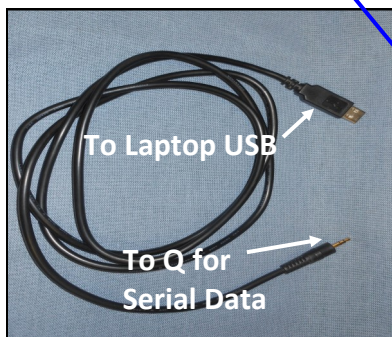
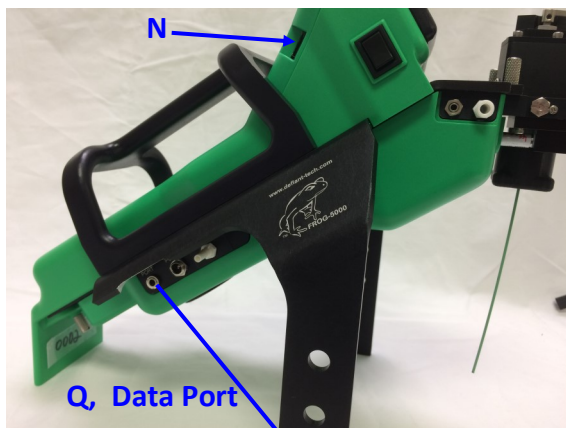

USB to Serial Data-Cable

4.2. Connecting to Computer/Ellvin Continued

Serial data-cable Connection

1. Connect the serial data-cable from the FROG's serial data port (Q) to a USB port on a computer.
2. Set the instrument power switch to the ON position.
3. If necessary, install Ellvin™ onto laptop or PC.
4. Open Ellvin™ by double clicking on the Ellvin™ icon.

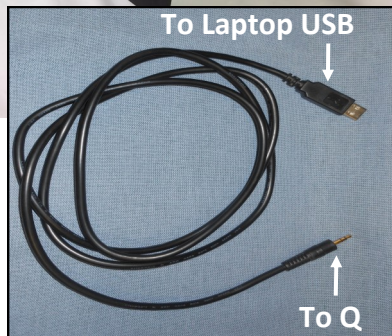

Serial Data-Cable

After Ellvin™ has opened, the default screen that appears is the chromatogram display screen in Live Data Window.

(Figure 4.2-1)

Figure 4.2-2 shows details of the display screen

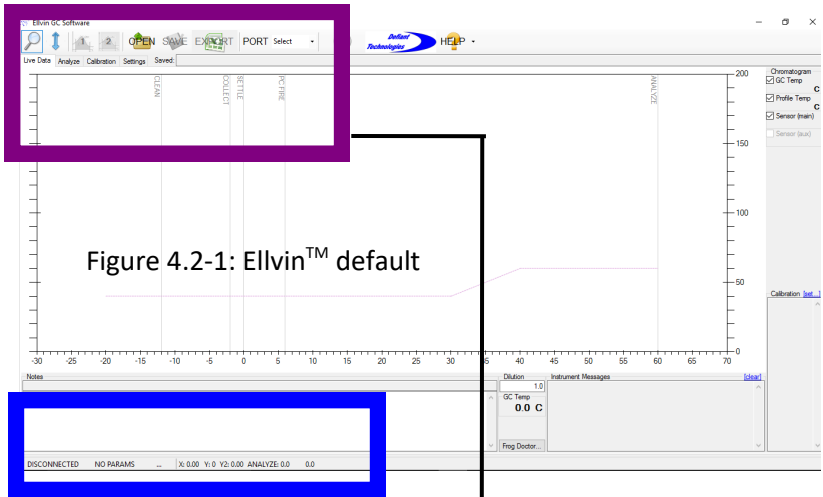

Figure 4.2-1: Ellvin™ default

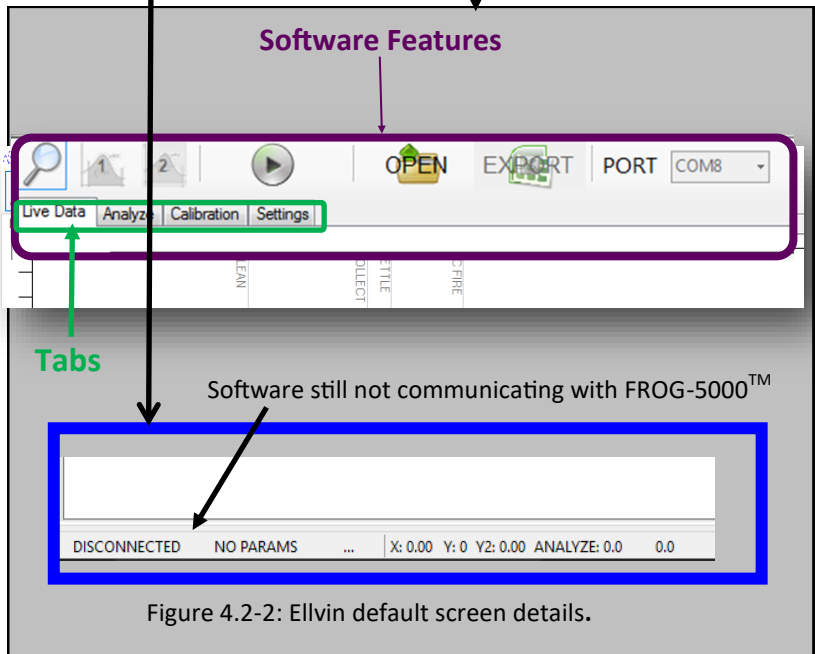
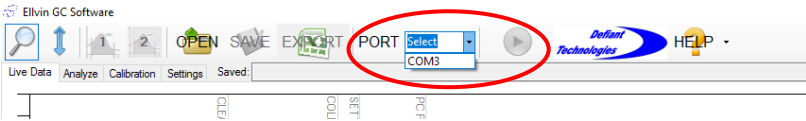

Figure 4.2-2: Ellvin default screen details.

4.2. Connecting to Computer/Ellvin™ Continued

- Click “Port” on the display screen, then select a COM#.



- The connection status indicator in the lower left corner should now read **CONNECTED** indicating that the FROG and Ellvin™ are connected. The user may now manage settings and run analyses from Ellvin™.
- If Ellvin™ ever disconnects with the FROG, a red flag will show in the lower left corner.

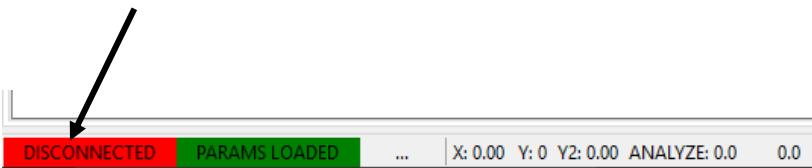
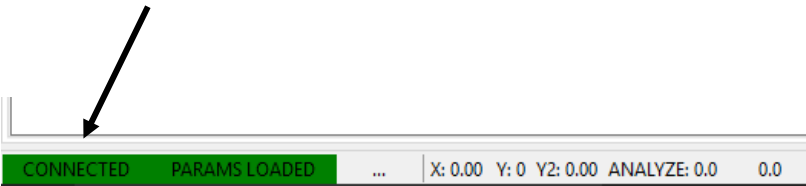

Section 4: Field and Lab Analysis Procedures Continued

4.3: Instrument Settings

The FROG-5000™ comes with general default settings for VOCs, which are shown in Figure 4.3-2 on the following page.

The settings determine the duration of different analysis phases, as well as the desired temperature of the GC column. The settings are defined and loaded to the instrument using Ellvin™. Table 4.3-1 on the following page describes the various settings.

The FROG-5000™ default settings are best for the analysis of Benzene, Toluene, Ethylbenzene and Xylenes (BTEX), but the settings can be altered for analyzing a wide variety of compounds and concentrations.

(See Appendix I for a list of detectable chemicals).

The current operational settings are stored in the FROG-5000™ memory and do not revert to the default settings when the instrument is disconnected from the software or power. They are retrieved and displayed under the Settings Window when the instrument is connected to a computer through Ellvin™.

Instructions for adjusting the settings begin on the following pages.

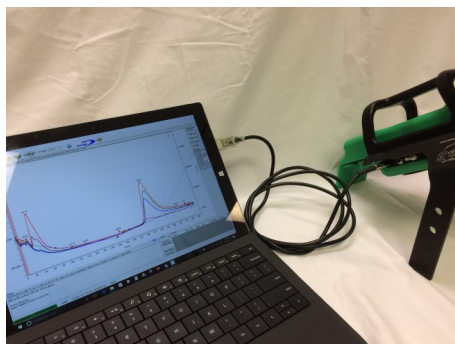

Connect to Ellvin™ to manage the settings.

4.3. Instrument Settings Continued

Table 4.3.1 Description of Settings	
Settings	Description
T_a	Hold time at lower GC temperature (seconds)
T_b	Ramp time from GC cold to GC hot temperature ($^{\circ}\text{C}$)
T_c	Hold time at hot GC temperature ($^{\circ}\text{C}$)
C_t	Initial cold GC temperature ($^{\circ}\text{C}$) NOTE: If used outdoors, the user must consider ambient conditions.
H_t	Final hot GC temperature ($^{\circ}\text{C}$)
COLLECT	Collection time of VOCs onto PC (seconds) This corresponds to the sparge time.
CLEAN	Time cleaning PC by heating (seconds)
PRESETTLE	Time PC cools after cleaning (seconds)
SETTLE	Time allowed for pressure to stabilize before PC FIRE (seconds) for GC analysis
FIRE	Time PC is Heated to Release VOCs (seconds)

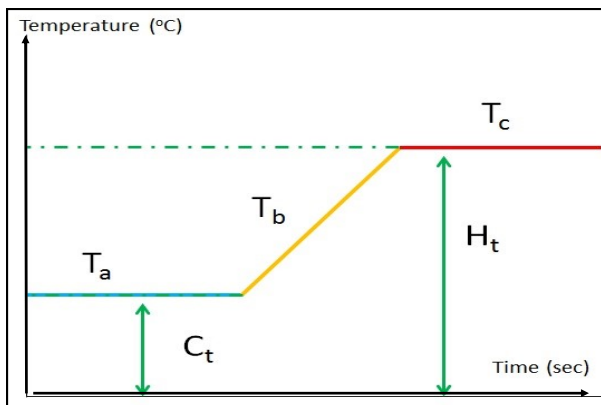

Figure 4.3-1: Description of GC Temperature Settings.

Defining and applying the settings.

1. Connect to Ellvin™. Refer to:

4.2: Connecting to Computer/Ellvin

2. Click on the Ellvin Settings Tab.

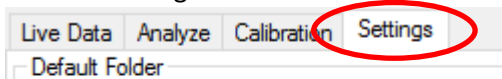

3. Type in a non-zero integer then click SET to apply the settings to the instrument. Changes to the settings are stored on the instrument. Settings **DO NOT** revert to the default parameters when power is removed or computer is disconnected. The minimum and maximum values are listed next to the Figure 4.3-2.

Parameter	Permitted Range	Current Settings	Text Box for New
Settings			
Ta	[2 - 900]	300	<input type="text"/>
Tb	[2 - 900]	120	<input type="text"/>
Tc	[2 - 900]	30	<input type="text"/>
Ct	[1 - 99]	60	<input type="text"/>
Ht	[30 - 150]	100	<input type="text"/>
COLLECT	[10 - 900]	60	<input type="text"/>
CLEAN	[2 - 10]	4	<input type="text"/>
PRESETTLE	[2 - 20]	4	<input type="text"/>
SETTLE	[2 - 20]	2	<input type="text"/>
FIRE	[2 - 10]	6	<input type="text"/>

Figure 4.3-2: Setting Window showing Default Settings

Section 4: Field and Lab Analysis Procedures Continued

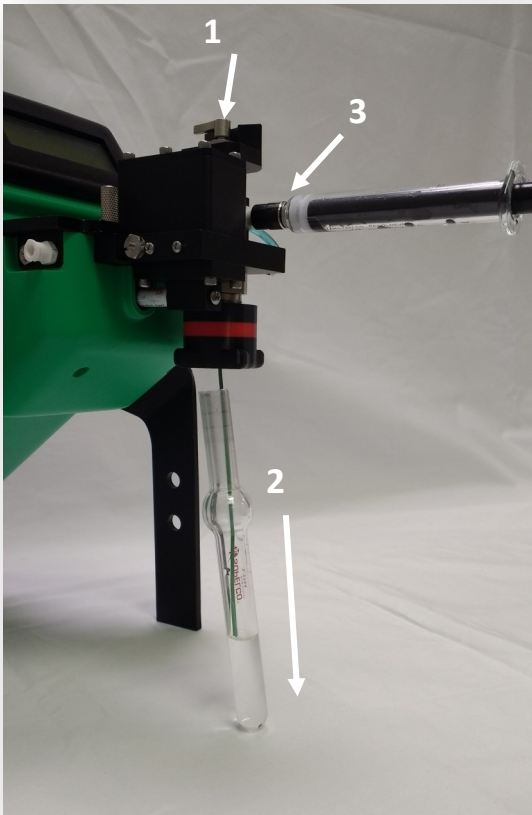

Figure 4.4-1 Rinsing the Instrument Steps 1-3

4.4: Instrument Preparation

Before running analyses, the instrument should be rinsed and display a clean baseline.

4.4.1. RINSING THE INSTRUMENT

1. Place the load/analyze valve in the LOAD WATER position.

(See Section 2.2.1)

2. Place sparge bottle in the DOWN Position.

(See Section 2.2.2)

3. Attach syringe with 5 mL deionized water to FROG-5000™.

(Figure 4.4-1, opposite page)

4. Load deionized water into FROG-5000™.

5. Remove sparge bottle and empty the water into waste container.

6. Repeat steps 3-5 twice more for a total of three rinses.

7. Remove and rinse sparge bottle with deionized water.

8. Replace the sparge bottle in the DOWN position.

Proceed to demonstrate a clean baseline (following pages).



Figure 4.4-2: Load/
Analyze Valve



4.4. Instrument Preparation Continued

4.4.2. CREATING A CLEAN BASELINE

A Clean Baseline should be achieved before analyzing a sample. This procedure ensures that there are no contaminants in the instrument that could effect the analysis results.

If the instrument is connected to a computer and Ellvin, the start button and display screen are in the software. If the instrument is not connected to Ellvin, the start button and display screen are on the instrument.

Rinse the instrument as described in Section 4.4.1 before attempting to achieve a clean baseline

Procedure:

1. Place load/analyze valve in the LOAD WATER position.
(See Section 2.2.1)
2. Place rinsed sparge bottle in the DOWN position.
(See Section 2.2.2)
3. Attach syringe with 5 mL deionized water to FROG-5000™.
4. Load deionized water into FROG-5000™
5. Place the load/analyze valve in the RUN WATER position.
6. Move the sparge bottle to the fully UP position and tighten the sparge nut in the clockwise direction until lightly snug.
7. Remove the empty syringe

Continued following pages.

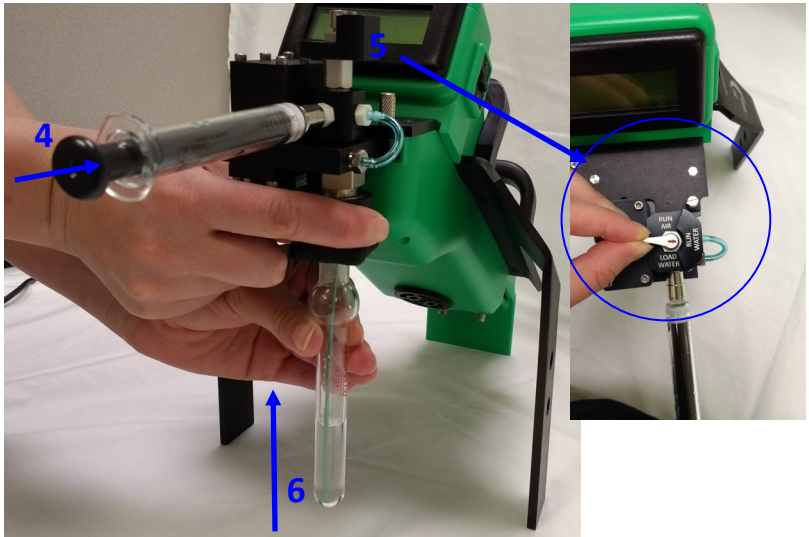
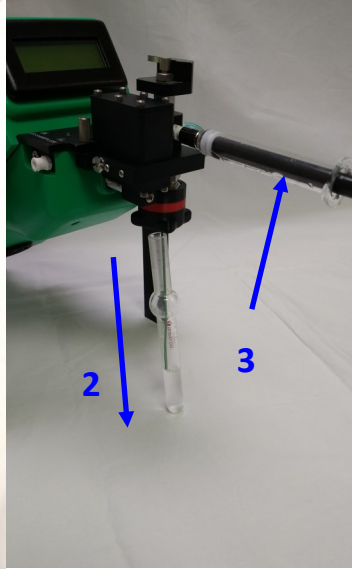
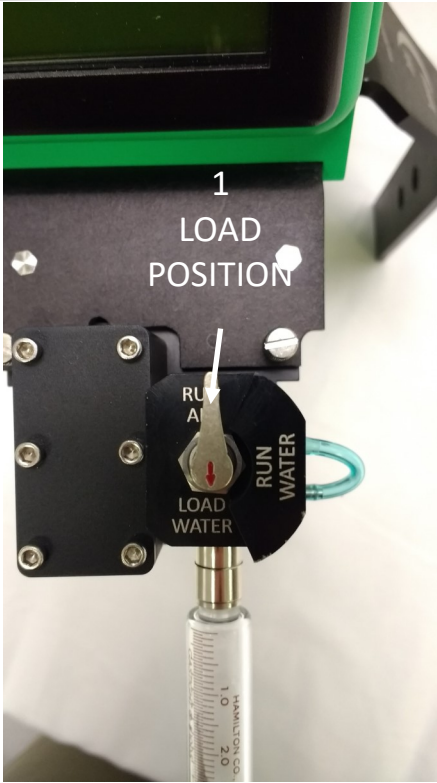

4.4.2. CREATING A CLEAN BASELINE CONTINUED

7. Begin an analysis cycle using deionized water. If connected to Ellvin™, click the start button in the software. If not connected to Ellvin™, press in the top of the black toggle button on the instrument. When the analysis is finished, a clean baseline should appear. A clean baseline is basically smooth with no significant peaks. A small peak at the beginning of the chromatogram and small waves in the clean baseline are acceptable.

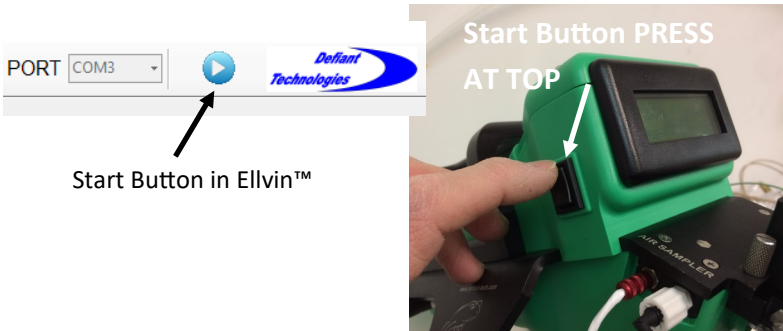

Clean Baseline on Ellvin™ Screen

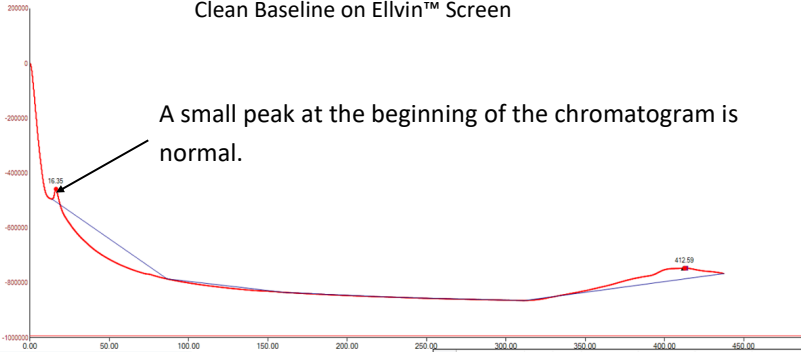

If Peaks **do** appear, repeat the instrument preparation procedures (4.4.1, Rinsing the Instrument and 4.4.2, Creating a Clean Baseline) until a clean baseline is achieved.

4.4. Instrument Preparation Continued

4.4.3. CONNECTING THE AIR SAMPLE ADAPTOR

If analyzing air samples, the user must first connect the air sample adaptor to the FROG.

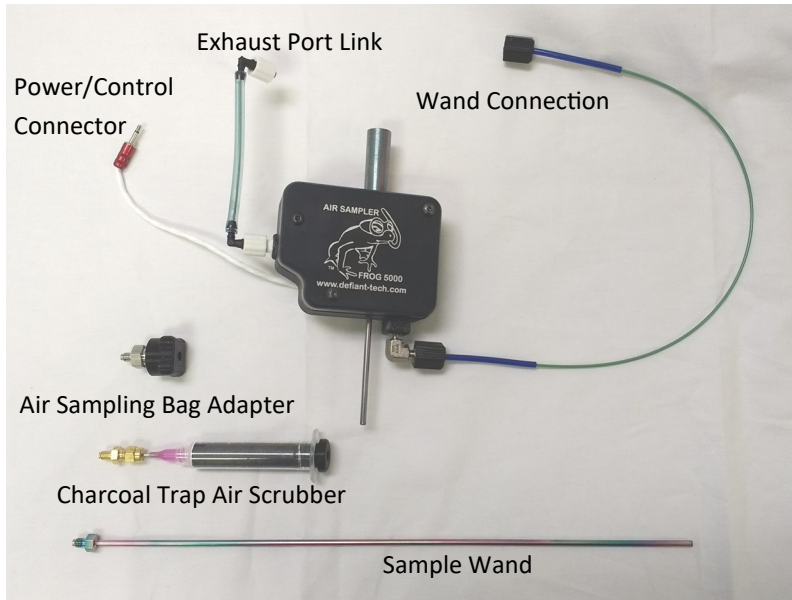

The air sample kit includes a sample wand and an air sample bag adapter. The air sample bag adapter enables direct connection to an air sample bag.

4.4.3. CONNECTING THE AIR SAMPLE ADAPTOR CONTINUED

1. Attach the air sampler to the FROG sparge block. Be sure the load/analyze valve is pointed to RUN AIR.
2. Connect the air sampler's power/control connector to the air sampler power port. This connection supplies power to the air sampler.
3. Attach the exhaust connector to the FROG exhaust with a twisting motion.

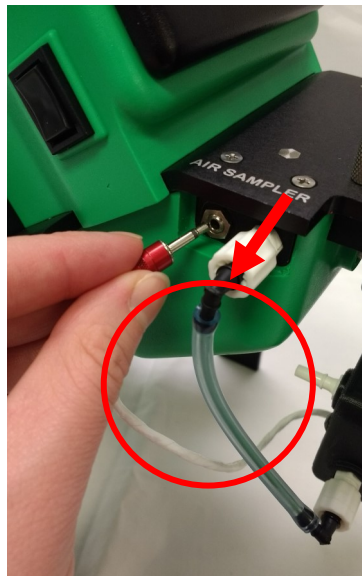
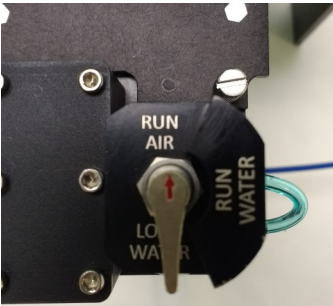

If the Sparge Bottle Nut was completely removed, make sure that the ferrule is properly assembled before it is installed.



4. A properly installed Air Sampler will look like the picture above.
5. The sampler can be used with air sample bags using the 1/16" to 3/16" adapter.
6. The sample bag adapter can be replaced with the wand for direct sample collection.
7. Connect the air sample wand to the air sampler as illustrated to the right.
8. It is advisable to install a syringe filter on the end of the wand in dusty environments.

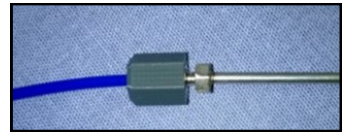
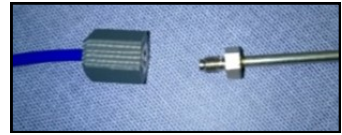
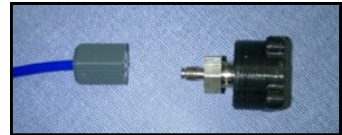
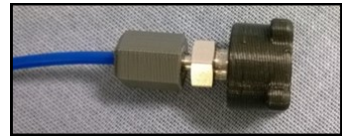



This page is intentionally
left blank.

Section 4: Field and Lab Analysis Procedures Continued

4.5: Loading a Sample

NOTE: The instrument should have a clean baseline to begin sample loading and analysis. Refer to:

4.4: Instrument Preparation

To ensure optimal sample analysis, adhere to the following sampling and cleaning procedures :

⇒ **Liquid Sample:**

- a. Pull 5mL of the sample liquid into a syringe.
- b. Transfer sample liquid to the sparge bottle.
- c. Rinse sparge bottle and syringe between test runs.

⇒ **Soil Sample:**

- a. Remove the sparge bottle from the instrument.
- b. Add 1 g of soil to the sparge bottle with then add 5 mL of clean water. (See our website for an application note on methanol extraction.)
- c. Rinse the sparge bottle thoroughly between samples.

⇒ **Air Sample:** Connect the air sampler adaptor and wand to the FROG (Section 4.4.3).

When running an analysis (Section 4.6), hold the wand in the area desired for sample collection.

If heavy concentrations are detected, run a sample of clean air to clear the system.

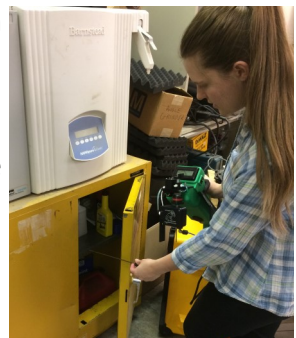

Detailed instruction begin on the following page.

4.5. Loading a Sample Continued

- If concentrations are known, during calibration for example, a series of samples of the **same** analyte may be run consecutively without rinsing the instrument. They must be run in order from low to high concentrations to prevent cross contamination.

Procedure:

1. Place load/analyze valve in the WATER LOAD position (open).
(See Section 2.2.1)

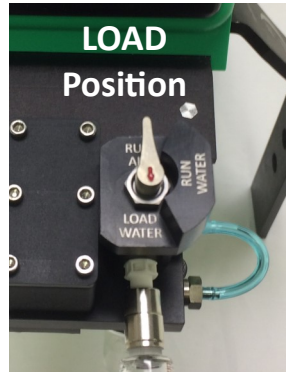

2. Load sample into sparge bottle

⇒ Liquid Samples: Place sparge bottle in DOWN position. Load 5 mL of sample through Sample Inlet

⇒ Silty Liquid Samples: Load 5 mL of sample directly into the top of the sparge bottle. Place sparge bottle in DOWN position.

⇒ Soil: Load 1 g sample directly into the top of the sparge bottle. Fill 5mL syringe with deionized water. Transfer the 5mL of deionized water into the sparge bottle while rinsing soil to the bottom. Place sparge bottle in DOWN position.

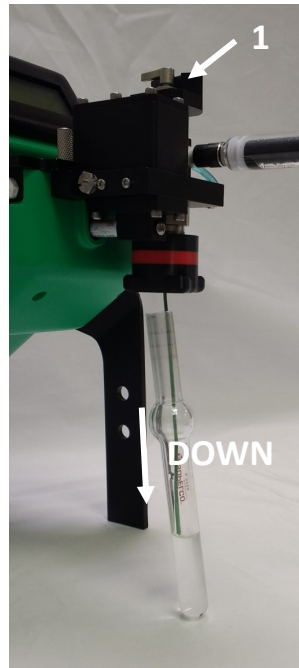

3. Immediately place the load/analyze-valve in the RUN WATER position (closed). The syringe may now be removed.



4. Return sparge bottle to the UP position. Rotate the sparge bottle nut counter clockwise until finger tight to secure the sparge bottle. The sparge bottle should not spin in the sparge bottle nut.

NOTE: When the sparge bottle is fully UP, the green sparge tube is near the bottom of the sparge bottle. A partially lowered sparge bottle will cause analyte peaks to shift right.

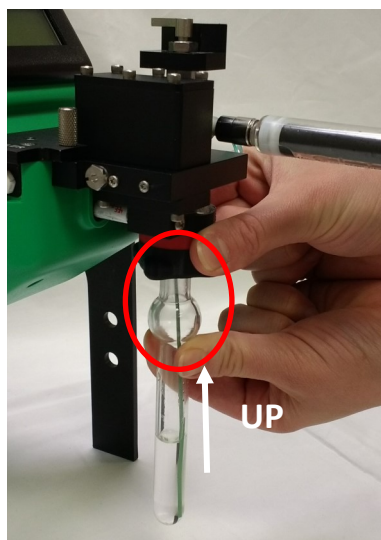

Sparge bottle
in the UP position.

4.5. Loading a Sample Continued

The instrument display screen shows **READY** throughout Steps 1-4 of Loading a Sample. The Log # is automatically generated and assigned to the data file produced by the current analysis cycle.

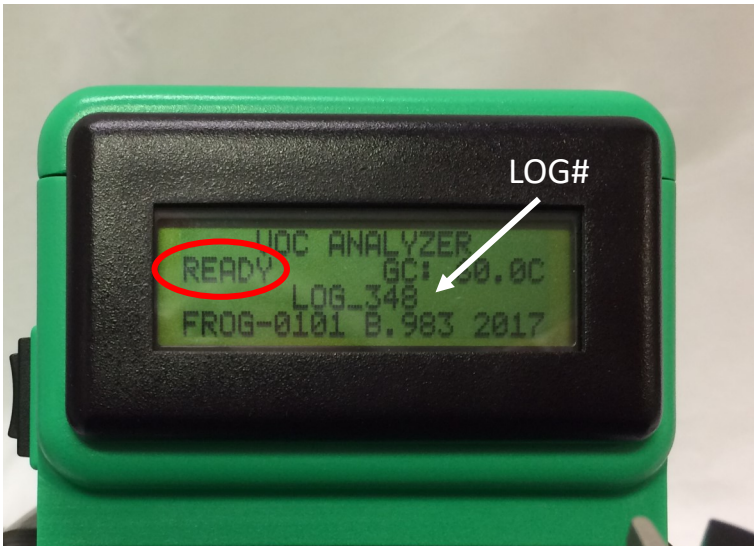

Section 4: Field and Lab Analysis Procedures Continued

4.6: Running A Sample

This section describes the procedure for running an analysis and the instrument's stages during an analysis cycle.

Procedure:

Record notes for future reference:

- If not connected to Ellvin™, the user should record the LOG #'s and other relevant information for future reference. The instrument records this number in the file name on the internal SD card.
- If connected to Ellvin™, the user can record relevant information for sample identification in the Ellvin™ Notes section. Ellvin™ automatically stores the analysis data file in a folder labeled with the date. The file itself is labeled with the time it was created.

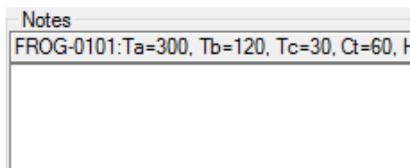

After the sample loading is complete (Section 4.5), the user may begin sample analysis by pressing the start button. If connected to Ellvin™, click the start button in the software. If not connected to Ellvin™, press the black toggle button on the instrument.



Start Button in Ellvin™



Continued next page.

4.6. Running a Sample Continued

During an analysis cycle, the FROG screen displays the analysis steps in sequence as illustrated below and on the following pages. This information is only visible on the instrument screen (not the Ellvin™ screen).

Each sequence has a clock counting down the duration of the current analysis step. The duration of the analysis step is determined by the instrument settings.

(See Section 4.3)

The GC TEMP may vary slightly from the set point.

Analysis Sequence

1. Cleaning Prior to Sparging:

The PC is heated to drive off contaminants (analytes from previous runs).

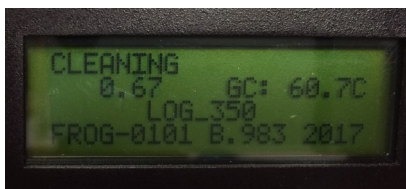

2. Settle:

The PC cools before sparge begins.

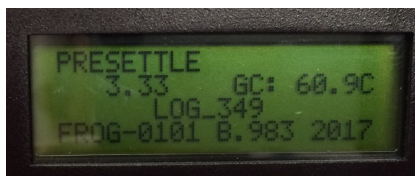

3. Collect:

VOCs are sparged and collected on the PC.



Continued next page.

4. Release and Analyze, Settle:

The sample flow is switched to the analysis channel. The pressure is allowed to stabilize before the PC fires.



5. PC Fire:

The PC is heated and analytes are injected (released) into the GC column and continue through to the PID.



6. Analyzing:

The PID measures analytes as they emerge sequentially from the GC.

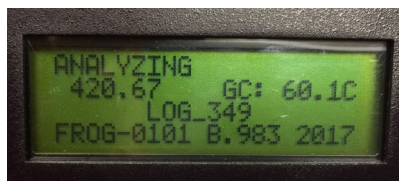

7. Results:

If the analysis was started by pressing the black toggle button on the FROG, the results will be provided on the screen.

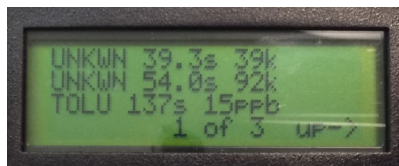

Continued next page.

4.6. Running a Sample Continued

Analysis Sequence Continued

8. Instrument Estimation:

When the instrument is not connected to Ellvin™, it makes an estimate of the analytes' concentrations based on calibration data.

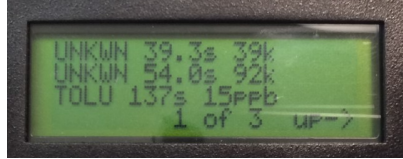

Press in top of Black Toggle Button to see analyte results



Click at the top of the black toggle button to scroll through results. Press bottom of toggle to go backwards. The two estimates shown in this example are 15 ppb Toluene and 53 ppb o-xylene. The GC retention time for Toluene is displayed as 137 s.

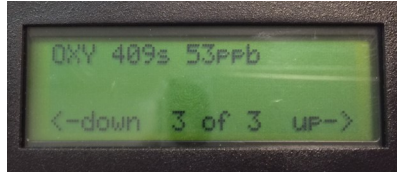

NOTE: The instrument estimates are only available immediately after the corresponding analysis. They are NOT stored on the instrument's SD card. Complete analysis chromatogram data *are* stored on the SD card and can be imported to Ellvin for further analysis.

9. Log File/WAIT:

The screen returns to the original display and shows the Log File # for the NEXT analysis. WAIT indicates that the GC temperature is above the lower GC set point.

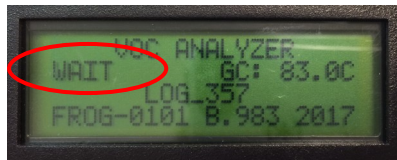

The FROG is ready for another sample loading and analysis once the GC Temperature indicator appears green and READY is displayed on the FROG screen.

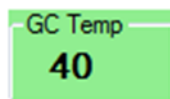
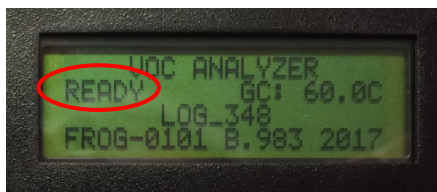

Samples of the same analyte may be run consecutively from low concentration to high without rinsing the instrument and creating a clean baseline.

NOTE: If the user has run a high-concentration sample, it is advisable to complete the following procedures:

⇒ Liquid or Air Sample, perform:

4.4: Instrument Preparation

⇒ Soil Sample: Remove sparge bottle from instrument and fill it with deionized water. Rinse it thoroughly to remove all dirt from bottle. Then, perform:

4.4: Instrument Preparation

Continued next page.

Final Step: If desired, use Ellvin™ for detailed results analysis after completing the analysis run.

- If the sample was run while connected to Ellvin™, open the data file in Analyze Window and use Integrator 2.
(See Sections 5.2.1 and 5.2.3)
- If the sample was *not* run while connected to Ellvin, import the data to Ellvin™ (Section 4.7), then open the file in Analyze Window and use Integrator 2.

Section 4: Field and Lab Analysis Procedures Continued

4.7. Importing Data to Ellvin

Ellvin™ allows the user to view live results, change operating parameters, re-plot stored data and overlay data for comparison. It also has tools for integrating peak areas, measuring retention times, and calibrating the instrument.

The FROG-5000™ stores data from every analysis on a micro-SD card. The following steps describe the process for extracting data from FROG-5000™ for analysis with Ellvin™.

1. Locate the micro-SD slot in the head of the FROG.
2. Press in on the card and release to eject the card.
3. Use a micro-SD adapter to plug the card into a USB or SD slot on a computer.
4. The micro-SD card performs as a thumb drive, and any file management program (such as Windows Explorer) can be used to move files.

Micro-SD Card Slot



4.7. Importing Data Continued

3. The computer screen will display an option to “Open folder and view files”. Open the folder.
4. The computer screen now displays a list of sequential files named “LOG_XXX”. The file names are created and assigned by the instrument. They appear on the instrument screen at the *beginning* of each analysis cycle as shown in Figure 4.7-1.

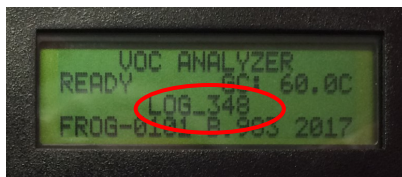
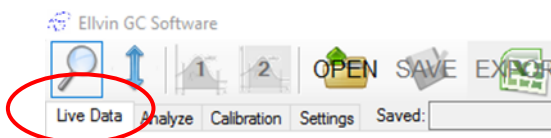

Figure 4.7-1: FROG-5000™ display screen at the beginning of a sample run.

NOTE: If the instrument is NOT connected to Ellvin™ when running analyses, the user must record the LOG file numbers of sample runs intended for future analysis. The LOG file numbers, as well as the instrument estimates, are only available on the instrument's screen at the time the sample is run.

5. Select the LOG file of interest and drag/copy it to the computer desktop or other location of user's choice.
6. Open Ellvin™.
7. Select Live Data Tab.



8. Click on the OPEN button.



9. Browse to the location where the LOG file of interest was dragged/copied.
10. At the bottom of the “Select Data File” window, change “Files of Type” to LOG Files.

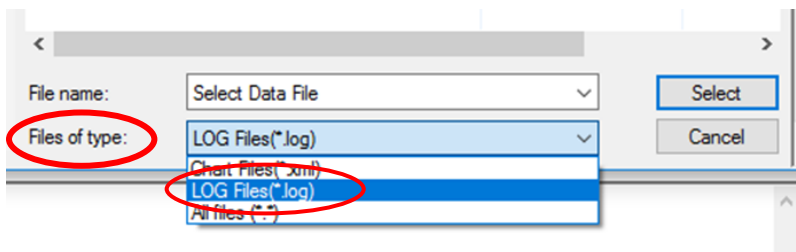

11. Select the LOG file of interest and open it.
12. The computer screen now displays a chromatogram of the file data as it is imported into Ellvin™. At this time, Ellvin™ also converts the data to an XML format and stores it. The location path of the stored data is displayed at the top of the chromatogram in the Live Data Window (Figure 4.7-2). The data can now be opened in the Analyze Window.

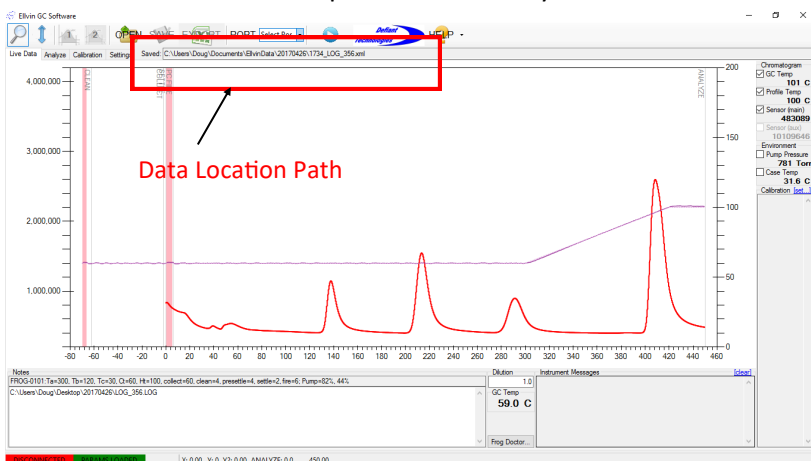

Figure 4.7-2: Live Data Window with chromatogram and data location path.

4.7. Exporting Data Continued



- 12. Click on the OPEN icon.
- 13. Follow the location path displayed in the Live Data Window to the folder that contains the data file of indicated.
- 14. Location Path Example:

C:\Users\.....\.....\EllvinData\20170426\1734_LOG_xxx.xml

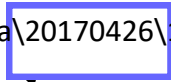

- 16. The highlighted numbers correspond to the *date* the storage folder and data file were created by Ellvin™. In this example, April 26, 2017.

The folder contains a list of files. The file names are derived from the *time* Ellvin™ converted the data. In the example in Figure 4.7-3, the file named “1734” was converted at 5:34 PM on 4/26/2017.

Folder name is the Date File name is the Time and Log#

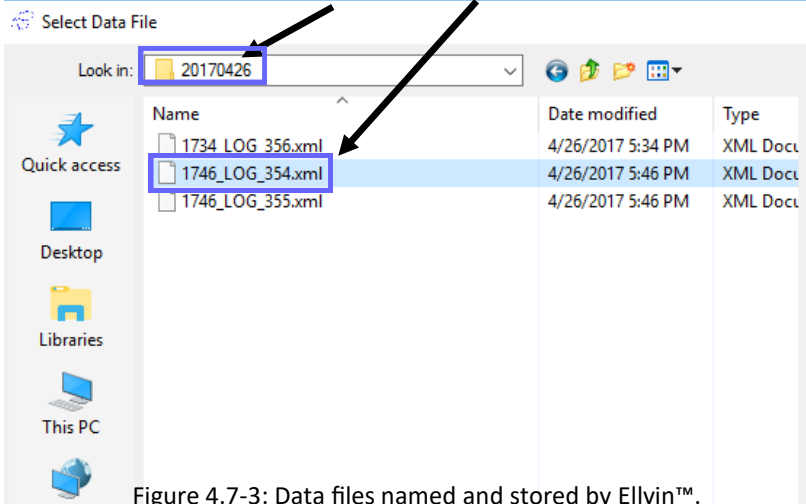

Figure 4.7-3: Data files named and stored by Ellvin™.

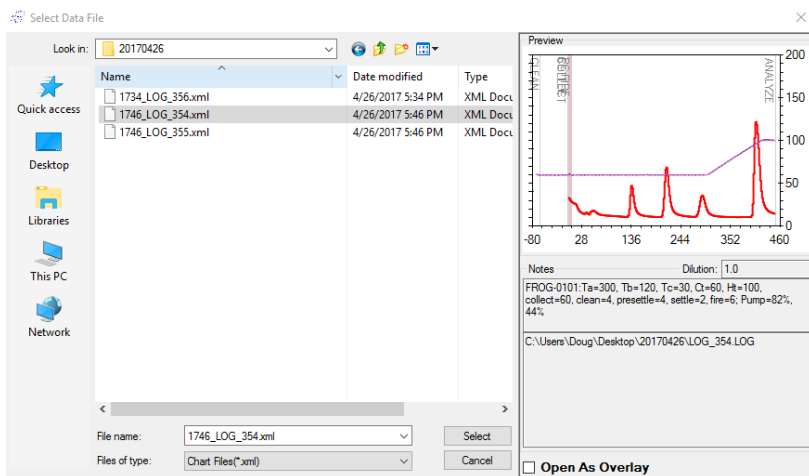

Figure 4.7-4: File Selection Screen

17. A preview chromatogram of the selected file appears to the right of the file list (Figure 4.7-4).
18. Click “Select” to open the file of interest. *Ellvin™ will automatically transfer to the Analyze tab and display the data.* Proceed to analyze the data with Ellvin™ Integrator 1 or 2. (See Section 5.2.3)



This page is intentionally
left blank.

SECTION 5: ELLVIN™ SOFTWARE

The chromatogram software, Ellvin™, is primarily used to perform detailed analyses of sample data. Ellvin™ uses calibration data to:

- Assign analytes to chromatogram peaks based on GC retention times.
- Report the analytes' concentrations based on peak heights and integrated peak areas.

Ellvin™ also manages the instrument settings and loads calibrations to the instrument.

Several general features of Ellvin™, as well as a few features specific to Analyze Window, are described in the following pages. The user should be familiar with all the features to use the system proficiently and look knowledgeable.

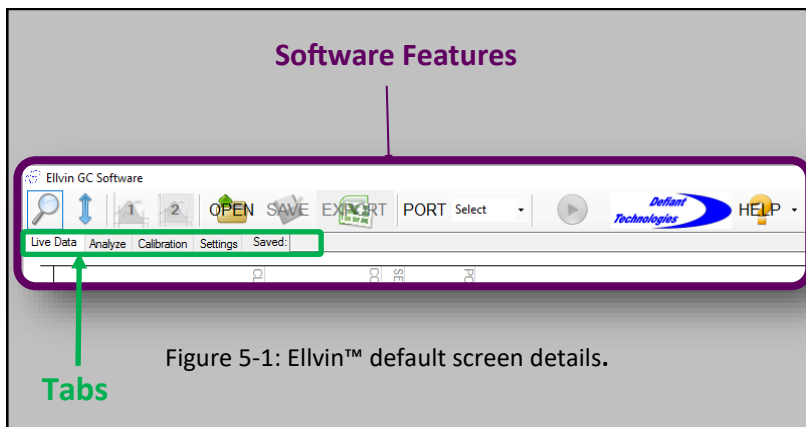

To start using Ellvin™, refer to:

4.2: Connecting to Computer/Ellvin™

Continued next page.



Section 5. Ellvin™ Software Continued

5.1. FEATURES OF ELLVIN™

WINDOWS

The Ellvin Software has four windows that are accessed with tabs when the software is open.



Window Tabs in Ellvin™

- **Live Data Window:** This is the default window for Ellvin™. In Live Data Window, Ellvin™ creates a chromatogram from sample analysis data. The data source may be:
 - a. From a sample run on the FROG while connected to Ellvin™ and simultaneously imported to Ellvin™.
 - b. From sample data previously recorded on the instruments SD card, then imported to Ellvin™.
- **Analyze Window:** As in Live Data Window, Ellvin™ creates a chromatogram from sample analysis data. In this window, Ellvin™ retrieves analysis data that was previously stored on a computer. In Analyze Window the user can examine chromatograms closely, integrate chromatogram peaks, and export data to Excel.
- **Calibration Window:** In this window, Ellvin™ uses analysis data from chemical standards to calibrate the FROG.
- **Settings Window:** In this window, Ellvin™ manages the settings for the FROG. The settings define temperature and duration parameters for various phases of the instrument's analysis cycle. Refer to:

4.3: Instrument Settings

PORT

Use this feature to select the correct data port connection from the FROG-5000™. The user selects a COM# to connect to the FROG.



Connection Port

Based on the selection of COM, the Connection Port will notify the user if the FROG is CONNECTED or DISCONNECTED, and if the parameters have been updated. (Bottom left corner of the software display screen).

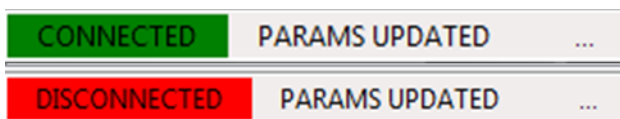

GC Column Temperature Indicator

This feature monitors and displays the GC temperature.

The icon is **GREEN** when instrument is ready for Loading.

It turns **GRAY** during sample analysis, and **RED** when the GC is cooling.

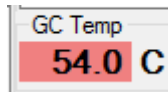
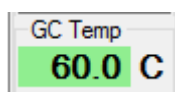

5.1. Features of Ellvin™ Continued

Start/Stop Button

Clicking on this button causes the FROG-5000™ to start an analysis cycle. Once the analysis has begun, the red stop sign appears. Clicking the stop button will stop the analysis and save the chromatogram to the point that the run was halted.



OPEN Button

Click on this button to open saved files. The files can be from data stored on a computer or on the instrument's internal micro-SD card.



EXPORT

Export only works when Ellvin™ is in Analyze Window. The user can export an opened file into Microsoft Excel program for further analysis.

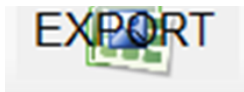

Chromatogram Display Screen

The software display screen shows sample analysis data.

- The X-axis is time in seconds.
- The Y-axis shows the instrument's PID response and GC temperature (°C).
- The peaks correspond to separated analytes.

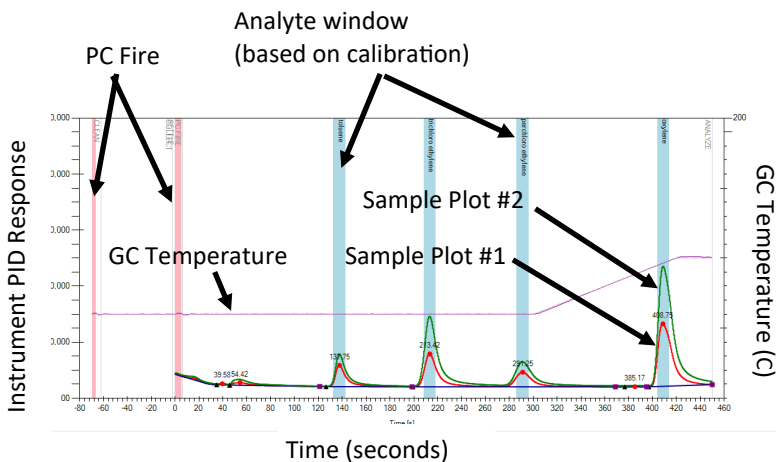

Plots of other run variables can be toggled on and off by checking boxes in the panel on the right portion of the screen. Information such as the analysis pump pressure and internal case temperature are stored for every run.

Chromatogram	
<input checked="" type="checkbox"/>	GC Temp C
<input checked="" type="checkbox"/>	Profile Temp C
<input checked="" type="checkbox"/>	Sensor (main)
<input type="checkbox"/>	Sensor (aux)
Environment	
<input type="checkbox"/>	Pump Pressure Torr
<input type="checkbox"/>	Case Temp C
Chart Data	
<input type="checkbox"/>	Hide Start of Run
<input checked="" type="checkbox"/>	PC Fire
<input type="checkbox"/>	Analytes (original)
<input checked="" type="checkbox"/>	Analytes (current)
<input checked="" type="checkbox"/>	Baseline
<input checked="" type="checkbox"/>	Peaks
<input checked="" type="checkbox"/>	Phases of Run
<input checked="" type="checkbox"/>	1531_LOG_352

5.1. Features of Ellvin™ Continued

Notes

This tool allows the user to records notes about samples while in Live Data or Analyze Window. The notes are saved when the sample analysis is completed. It is important to record the date and time that data files are created in order to locate and retrieve them for further analysis.

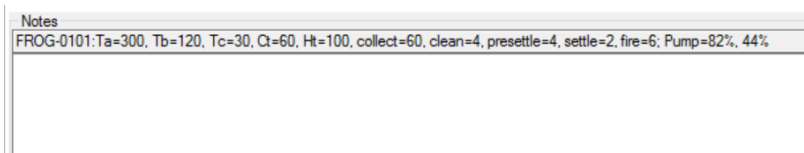

Magnifying Glass

Use this tool to zoom into a chromatogram while data is being collected in Live Data Window, or while in Analyze Window to help with integration.

Detailed instructions for using Magnifying Glass follow in Section 5.2.2.



MOVE

Use this tool to move the chromatogram up and down the Y-axis.



Integrator 1

This feature only operates while in Analyze Window. The user creates a baseline and integrates peaks, then calculates the peak height and area. The baseline integration limits are set by clicking the left mouse button.

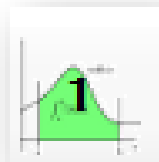

Integrator 2

This feature only operates while in Analyze Window. Ellvin™ creates a baseline by snapping vertically from the left mouse click position to the data line. Ellvin™ then calculates the peak height and area. Integrator 2 is recommended for the most consistent analysis results. Detailed instructions for using Integrator 2 follow in Section 5.2.3.

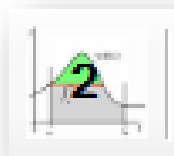

Data Grid

Use with Integrator 1 and 2. The Data Grid shows:

- Analyte (Toluene) *Based on calibration retention times.*
- Peak Reference Number (1)
- Retention Time (138.08s)
- Peak Height (732529)
- Peak Area (7960892)
- Calculated concentration (14.1037) *Based on calibration concentrations.*

Results						
Analyte	Peak	Time	Height	Area	Concentration	Final Conc.
toluene	1	138.08	732529	7960892	14.1037	14.1037



Section 5: Ellvin™ Software Continued

5.2. APPLYING ELLVIN™ FEATURES

5.2.1. OPEN BUTTON

To open stored files in Analyze Window:

- Click on the Analyze Tab.

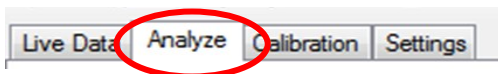

- Click the OPEN button.
- A file selection screen appears.
(Figures 5.2.1-1 and 5.2.1-2)



NOTE: Ellvin™ automatically labels folders and files as they are created.

- ⇒ Folders of data files are labeled by the DATE they were created.
- ⇒ Data files are labeled by the TIME they were created and the LOG number.

In the example shown in Figure 5.2.1-1, the data file was created at 10:01 AM on April 26, 2017.

- To locate the data file of interest, browse to the folder labeled with the *date* the sample was ran, or the *date* the data file was imported from the FROG to Ellvin™. Double click to open the folder.
- Click on a data file of interest. A preview of the data chromatogram appears to the right of the list.
- Click “Select” to open the file for analysis with Integrator 2.

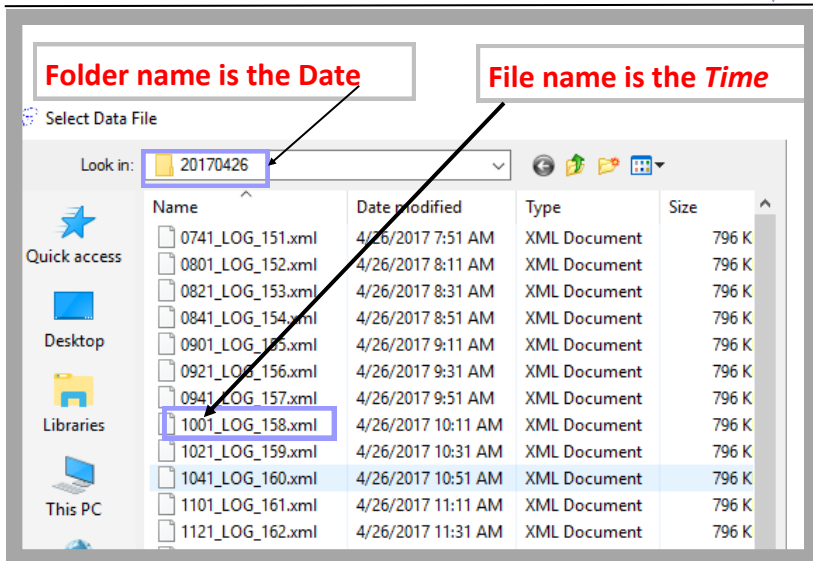

Figure 5.2.1-1 Data files

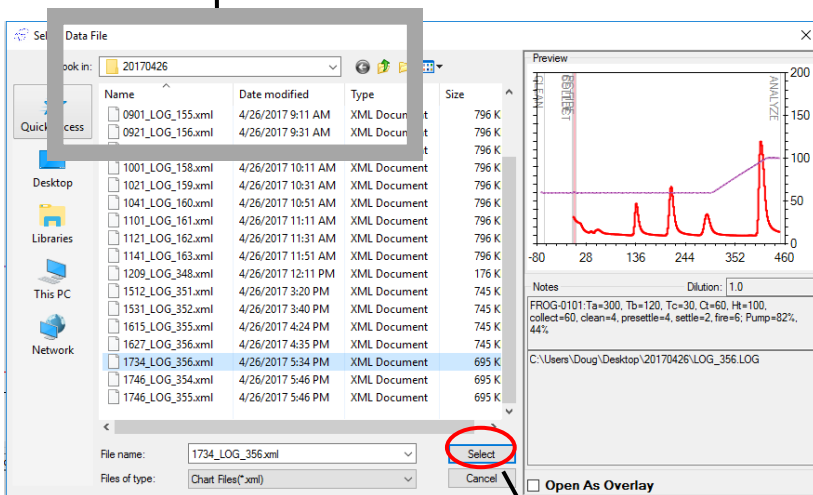
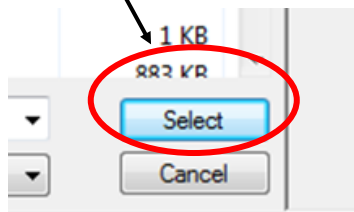

Figure 5.2.1-2: File Selection Screen



5.2. Applying Ellvin Features Continued

5.2.2. MAGNIFYING GLASS

The Magnifying Glass can be used in Live Data Window during data import, or while in Analyze Window.

Click on the magnifying glass icon to start.



To Magnify:

- Left click and hold
- Drag mouse over desired magnified area.
(Figure 5.2.2-1)
- Release the mouse button.
- The area being magnified is highlighted light blue.
- The display screen then readjusts to show the magnified area.
(Figure 5.2.2-2).

To De-Magnify:

- Click the circle on the scroll bars.
- OR double click the magnifying glass icon.

Figure 5.2.2-1: Desired Magnified Area

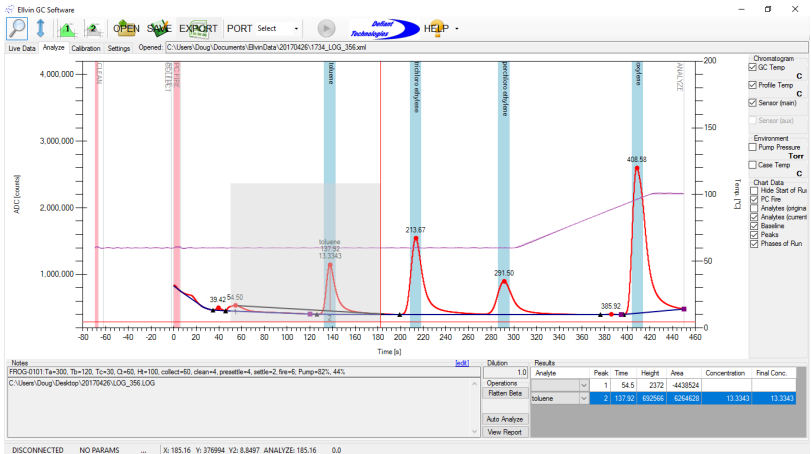
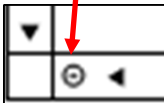
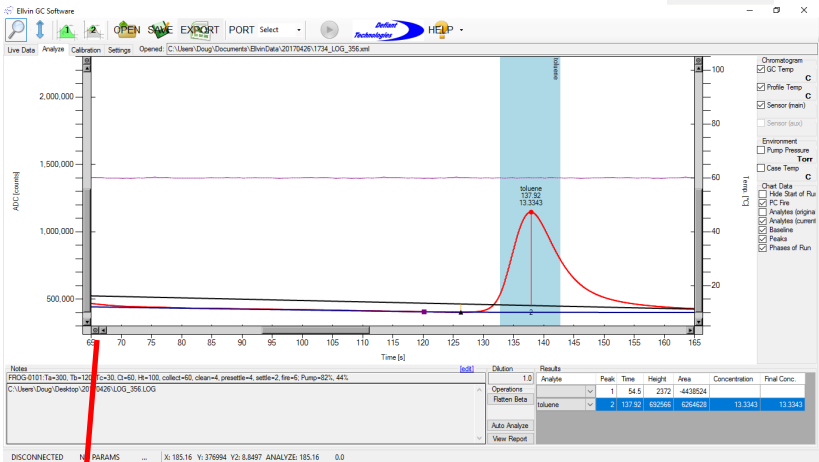

Figure 5.2.2-2: Magnified Area



5.2. Applying Ellvin™ Features Continued

5.2.3. INTEGRATOR 2

Integrator 2 can be used only in Analyze Window. This tool calculates the area under a peak and the peak height. The area or peak height helps determine the concentration of the analyte.

Click on the Integrator 2 button to start.



Technique to Integrate:

(Refer to Diagrams 5.2.3-1 and 5.2.3-2)

1. Begin at the lowest point, Valley 1.
2. Drag the mouse to draw an integration line, past the peak, to the second lowest point, Valley 2.
3. The integration line should NOT cross the data line. Avoiding this ensures the correct calculation for the peak area. (Figure 5.2.3-2).

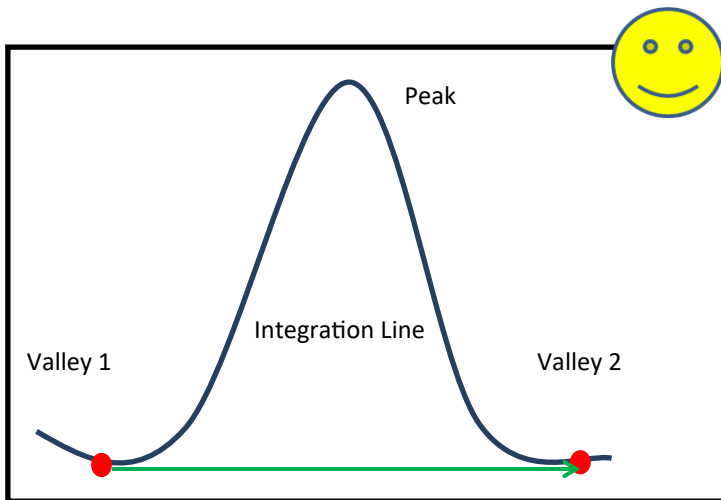

Diagram 5.2.3-1: Valleys and Peaks

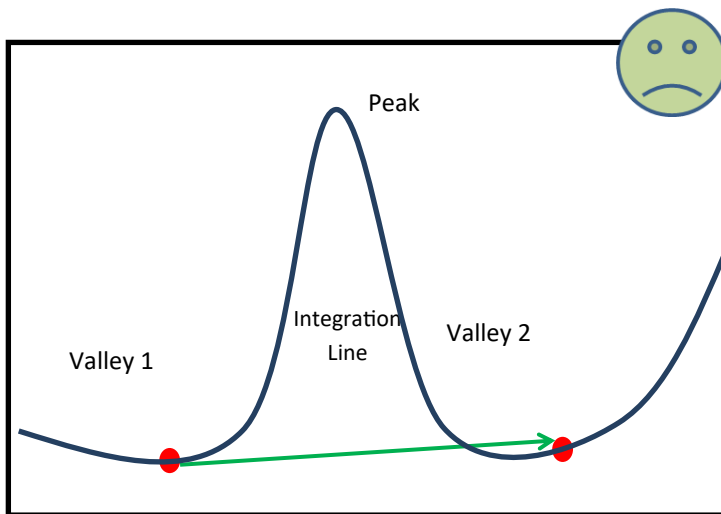

Diagram 5.2.3-2: Crossing Data Line

5.2.3. Integrator 2 Continued

Integrating a Single Peak

Using the correct technique illustrated on the previous page, select the desired peak for integration.

1. Select Integrator 2.



2. Left click the mouse and hold at Valley 1.
3. Drag to Valley 2 and release.
4. The Integrator 2 tool uses the software to select the baseline on which the integration line is drawn.
5. The gray shadowed area in Ellvin™ will show which area is being integrated. (Figure 5.2.3-3)
6. The integration is complete when a solid black line appears.
7. The Data Grid shows the data that corresponds to the related peak number near the base of the peak. The user can continue integrating peaks.

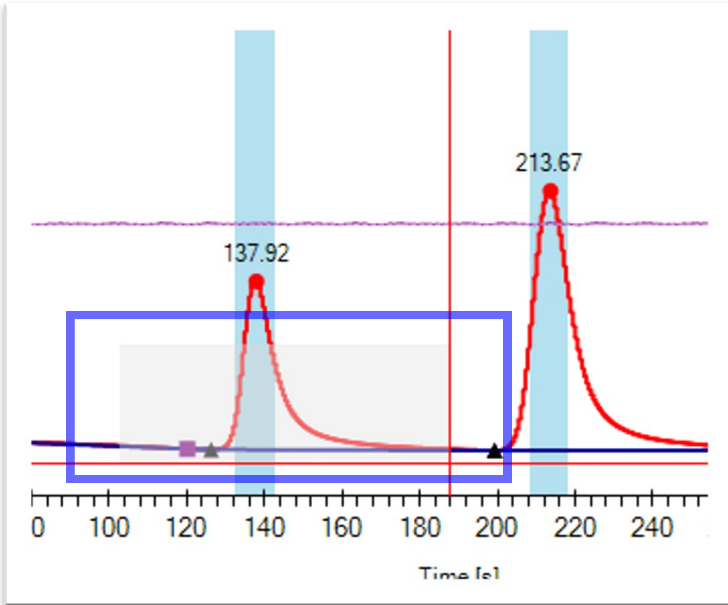

Figure 5.2.3-3: Desired Peak Integrated Area

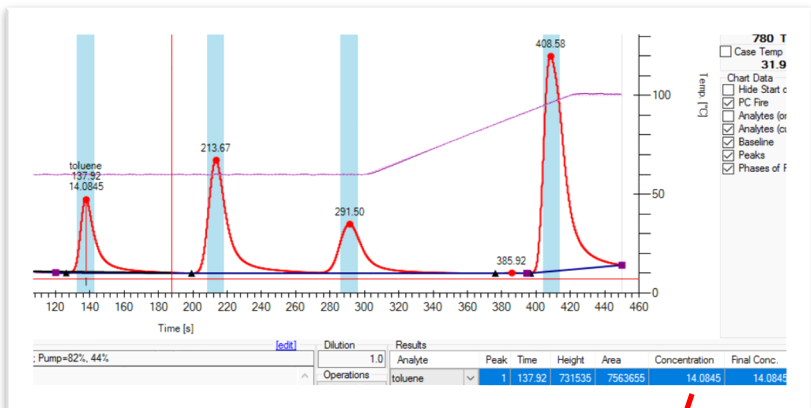

Figure 5.2.3-4: Integration Line

Results						
Analyte	Peak	Time	Height	Area	Concentration	Final Conc.
toluene	1	137.92	731535	7563655	14.0845	14.0845

Data Grid

5.2.3. Integrator 2 Continued

Integrating Multiple Peaks

To integrate multiple peaks, follow the same procedures for integrating a single peak using Integrator 2.

Click on the Integrator 2 button to start.



1. Right click and hold the mouse at Valley 1.
2. Drag to Valley 3 and release.
3. The integrator uses Ellvin to select the baseline on which the integration line is drawn.
4. The integration is complete when a solid black line appears. The result shows the integration line and the splits placed between joined peaks. (Figure 5.2.3-5)
5. To integrate the remaining peak (in Figure 5.2.3-5, Peak 3). Click and hold at Valley 3 and drag to Valley 4.
6. The Data Grid shows the data that corresponds to the related peak. The user can continue integrating peaks.

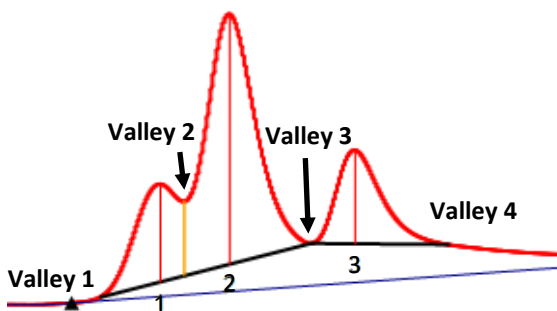

Figure 5.2.3-5: Integration of multiple peaks complete.

Results						
Analyte	Peak	Time	Height	Area	Concentration	x Dilution
Ethylbenzene	1	327	288504	2415377	6.30891	6.30891
PM-Xylene	2	338.67	738267	7386991	11.5795	11.5795
o-Xylene	3	359.83	276341	2417951	7.85937	7.85937

Data Grid

When integrating multiple peaks it is necessary to follow the baseline as closely as possible. It is recommended that each peak be carefully assessed before integration. It is usually best to integrate each peak separately unless the valley between the peaks does not reach the baseline as in the case of peaks 3 and 4 in the figures below (Figure 5.2.3-6 and Figure 5.2.3-7).

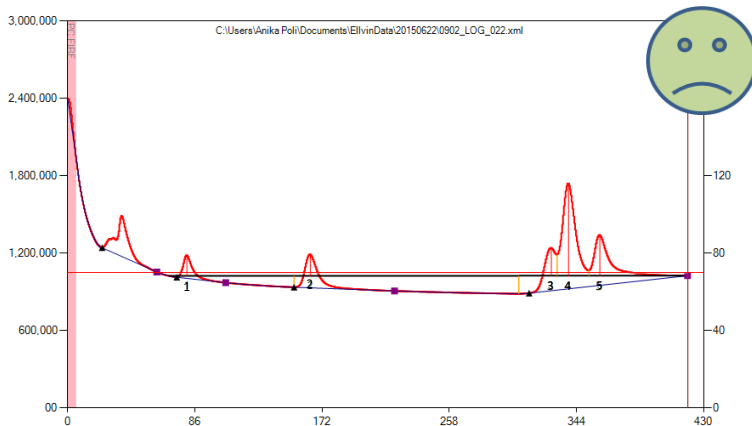

Figure 5.2.3-6: Improper integration of Multiple Peaks

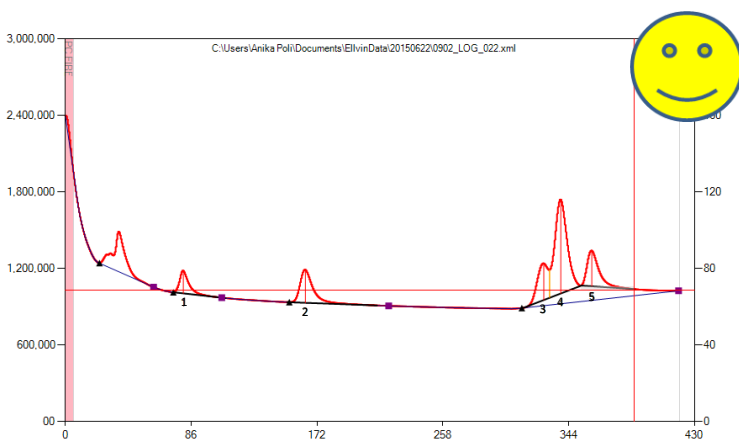

Figure 5.2.3-7: Proper integration of Multiple Peaks



This page is intentionally
left blank.

SECTION 6: CALIBRATION

This section provides detailed instructions for calibrating the instrument.

The system is calibrated by testing a series of analytes at varying, known concentrations. As with all GC work, these analytes are selected from an established list of chemicals that are of foremost interest in the environment under investigation.

- Before beginning a calibration, it is recommended that the user become familiar with Ellvin™. Refer to Section 5.
- The user should also be familiar with analytical techniques for GC calibration.
- The preparation and use of standards for calibrating the instrument differs for air, liquid, and soil samples. Section 6.1 introduces the procedure for preparing standards.
- Section 6.2 provides detailed instruction for using the features found in Calibration Window.
- Section 6.3 provides detailed instructions for calibrating the instrument.

Section 6: Calibration Continued

6.1. CALIBRATION STANDARDS

NOTE: The instruction in Sections 6.1.1 and 6.1.2 correspond to Step B-3 in Section 6.3.

6.1.1. STANDARDS FOR LIQUID OR SOIL SAMPLES

For screening purposes, a calibration can be created with a single known sample. However, it is best to run at least four calibration samples from low to high concentrations.

General concepts to calculate the dilutions

Traditionally, ppb concentrations of analytes in water are expressed in micrograms of analyte per liter of water (=1 Kg water). Calibration standards come pre-diluted in methanol. Methanol cannot be ionized (and therefore not detected) by the instrument's PID.

The standards are frequently referred to in terms of ppm, but if you carefully look at the packaging, somewhere, it should say x.x-mg analyte/mL-Methanol. For example, a common fuel mixture, BTEX, will be provided as 2.0-mg/mL-methanol and often this is referred to as a 2000-ppm standard because it is 2000 μg BTEX/mL methanol.

The important thing to follow is the mass of the analyte in the sample. If you draw 5- μL of the 2000 ppm BTEX solution into a syringe, the syringe contain 0.005-mL x 2000- $\mu\text{g}/\text{mL}$ (or 10 μg) of benzene, 10 μg of toluene, 10 μg of ethylbenzene, and so on. If you inject this 5- μL syringe BTEX standard into 5-mL of water, there will be 10- μg of benzene in the 5-g of water, In other words, the benzene contamination is 2- μg benzene/1-g water = 2000 ppb.

Handy things to know:

1 µg/mL = 1 mg/L = 1 ppm (mass) 1 µg /L = 1 ppb (mass)

BTEX = Benzene, Toluene, Ethylbenzene, p/m-Xylene, o-Xylene

Diluting 5mL Water with Standard

The density of water is 1 g/mL, so if a syringe contains 5 mL of water, it means that there are 5 g of water in the syringe.

If you have a 200ppm benzene standard, what is the resulting concentration from injecting 2µL (=0.002 mL) of the 200ppm benzene standard into the 5-mL water filled syringe?

$$\begin{aligned} \frac{200 \mu\text{g Benzene}}{\text{mL Methanol}} \times \frac{0.002 \text{ mL Methanol}}{5 \text{ g H}_2\text{O}} &= \\ = \frac{0.08 \mu\text{g Benzene}}{1 \text{ g H}_2\text{O}} &= \frac{80 \mu\text{g Benzene}}{1 \text{ kg H}_2\text{O}} = 80 \text{ ppb Benzene} \end{aligned}$$

There will be a concentration of 80 ppb benzene in the water.

Diluting from a Standard

Let C_A = original concentration of an analyte in a solvent, and F = desired dilution factor so $C_B = C_A / F$. Find V_A = volume of mix C_A that must be added to a solvent volume V_B to achieve concentration C_B , where m_A is the mass of analyte in V_A .

$$m_A = C_A V_A$$

$$C_B = \frac{C_A}{F} = \frac{m_A}{V_B + V_A(1 - C_A)} = \frac{C_A V_A}{V_A + V_B} \quad (\text{approx. for low } C_A)$$

Solving for V_A yields:

$$V_A = \frac{V_B}{F - 1}$$

Example: Using $C_A = 2000 \mu\text{g/mL}$ BTEX in MeOH standard to make a $C_B = 200 \mu\text{g/mL}$ BTEX in MeOH standard (that is $F = 10$), you must add 0.1 mL of C_A to 0.9 mL MeOH to make a 1 mL standard of 200 µg/mL BTEX in MeOH.

6.1.1. Standards for Liquid and Soil Samples Continued

Preparation Continued:

2. Fill a syringe with 5 mL deionized water.
3. Load a known volume, as calculated on the previous pages, of a liquid standard into the syringe.
4. Connect to Ellvin™ and follow the sample loading instructions in Section 4.5.

4.5: Loading a Sample

6.1.2. STANDARDS FOR AIR SAMPLES

Gas calibration standards are available from several sources, and we recommend searching the internet with the term “Calibration Gas Standards.” The standard typically comes in a pressurized cylinder with a mixture of analytes in nitrogen to achieve the proper dilution. A typical mix for calibration would be 100 ppbv BTEX in N₂. Concentrations are typically in parts per billion by volume.

A regulator on the bottle controls the flow and pressure at the exhaust. Because sample will be collected directly from the atmosphere, we suggest connecting the FROG’s sample tube to the bottle with a Tee. One port on the tube should vent to the atmosphere and flow of the sample gas should exceed the collection flowrate of the FROG (~60 mL/min).

The FROG permits the creation of a single point calibration, and this is adequate for many applications. Results will be good near the calibration gas concentration, but less reliable further from that concentration. Multiple point calibrations are preferred.

6.1.2. STANDARDS FOR AIR SAMPLES (CONTINUED)

Run at least four calibration standards from low to high concentrations. Defiant Technologies sells a portable gas diluter accessory to be used with the FROG for air calibrations.

Tools Needed:

- Portable Gas Diluter
- Calibration Gas
- Air Sampler



Gas Diluter attached to Calibration gas and FROG

Instrument Preparation:

- Connect Air Sampler to instrument and then connect air sampler to the gas diluter. Place load/analyze-valve in the load position (open). (See Section 4.4.3 Connecting the Air Sample Adapter).
- Connect the calibration gas to the gas diluter.

Continued next page.

6.1.2. Standards for Air Samples Continued.

Standard Preparation and Loading:

1. Use the spreadsheet provided with the Gas Diluter. This will allow for the calculation of sample concentration using the starting concentration of the calibration gas.
2. Adjust the flow rates on the gas diluter until stable at the desired rates.
3. Press the start button and run sample.

Refer to:

4.6: Running A Sample

4. Repeat for other sample concentrations.

For more detail on the air calibration procedure using the Gas Diluter please refer to the Gas Diluter User's Manual.

Another method to perform multiple point calibrations is to buy multiple compressed standards, or alternatively, to prepare multiple concentrations in Tedlar™ gas sample bags. We will not go into details on these procedures. We will point out, however, that it can be difficult to achieve accurate concentrations much below 20 ppbv. Low concentration samples tend to degrade in compressed cylinders, and sample bags often have contaminants that appear as large peaks in the chromatography. It is still possible to achieve reasonable results, and a Frog user is welcome to call Defiant Technologies for further discussions. Contact information can be found at www.defiant-tech.com.

Section 6: Calibration Continued

6.2. ELLVIN™ CALIBRATION WINDOW FEATURES

- To start using Calibration Window, open Ellvin™ and click on the Calibration Tab.



6.2.1. LIST OF ANALYTES

This feature allows the user to create a List of Analytes that may be used to calibrate the instrument. The analyte names in the List of Analytes will later be associated with analyte peaks from calibration standard runs. (See Figure 6.2.1)

The Retention Time, Peak Height, and Peak Area in Figure 6.2.1 are generated from previous analyses of standard solutions with known concentrations.

The screenshot shows the 'Calibration File' window in Ellvin GC Software. The 'Analytes' list on the left includes Benzene, Toluene, Ethylbenzene, p-/m-xylene, and o-Xylene. The 'Properties' window on the right displays the following data:

Peak	Time	Height	Area	Concentration	FileName
1	39.67	6844	18479	2	C:\Users\Anika Poli\...
2	38.67	35467	170763	8	C:\Users\Anika Poli\...
3	38.75	150279	753709	20	C:\Users\Anika Poli\...
4	39.42	307720	1686257	40	C:\Users\Anika Poli\...
5	39.83	634424	3519458	80	C:\Users\Anika Poli\...

Additional properties shown include: Alias: BENZ, Retention Time: 40.92 s, Time Window: 10.00 s, and Chemical: Benzene.

Figure 6.2.1: Typical entries used to build a calibration file.

Creating a new calibration

1. Click on the New File Icon
2. Click on the New Analyte Icon
3. At this point, a pop-up window appears requesting an analyte name and an alias that will appear on the FROG display after a run. In this example, the alias BENZ is given for benzene.
4. Click OK and this analyte will be added to a list of analytes.
5. Add as many analytes as needed for the calibration. If you want to delete one, just click on the name, and use the delete button on the computer.

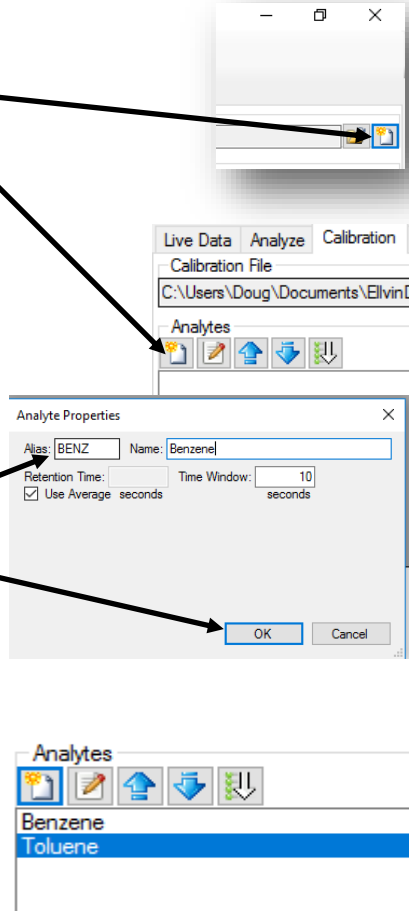

At this point, you are ready to run calibration standards to produce the calibration data. That data will be peak heights and integrated peak areas for multiple concentrations for each analyte. Because the samples are separated in the chromatogram, multiple analytes can be tested in a single sample run.

For each analyte, the peak area (or height) will be correlated with the concentration through a linear or quadratic equation.

6.2. Calibration Window Features Continued

6.2.2. CORRELATION CHART AND EQUATIONS

This feature in the Calibration Window displays the degree of correlation between analyte standards of varying concentrations and the instrument's response to them.

(See Figure 6.2.2)

The correlation is calculated as both a linear equation and a 2nd order quadratic equation.

The user may choose to view the equations and a chart for either Peak Area correlation or for Peak Height correlation.

This correlation is important because Ellvin uses these parameters to calculate concentrations for future samples.

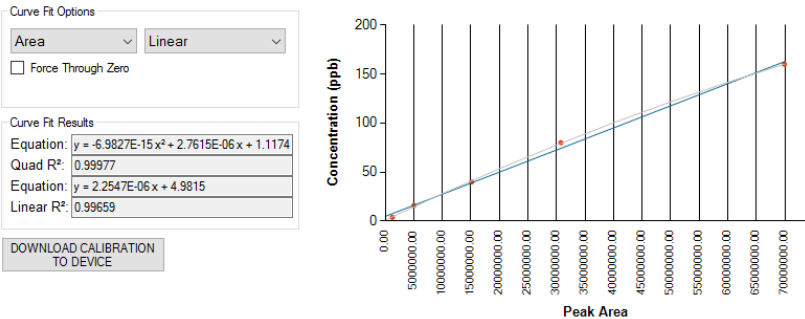

Figure 6.2.2: Correlation Equations and Chart

Section 6: Calibration Continued

6.3. CALIBRATION PROCEDURE

The Calibration Procedure consists of running a series of analysis cycles with standards of varying concentrations for a given analyte. Ellvin™ then uses the analysis data for the standard solutions to calibrate the instrument.

Before beginning a calibration, the user should be familiar with:

4.3: Instrument Settings

4.4: Instrument Preparation

4.5: Loading a Sample

4.6: Running A Sample

5.1-5.2: ELLVIN™ Software

It is recommended to run a minimum of four standards, from low to high concentration, to create data points for calibrating the instrument.

The concentration range for calibration standards depends on the analyte and its unique retention time.

Example standard concentrations for a calibration: 2 ppb, 10 ppb, 50 ppb, 100 ppb

Calibration Procedure Steps

A. Add the Calibration Analytes to the List of Analytes.

(See Section 6.2.1)

The steps in this section prepare the software to calibrate using selected analytes.

1. Open the Calibration Window.

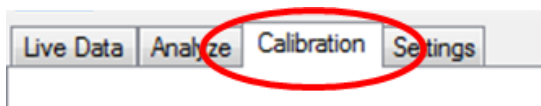

2. Begin by adding each of the analytes chosen for calibration, one at a time, to the Analyte List.

(See Section 6.2.1)

- No data will be displayed and the chart display area will be blank. Disregard any equations displayed.

Continued next page.

6.3. Calibration Procedure Continued

B. Run the Calibration Standards

In this section, the calibration samples are loaded and instrument response data is stored.

1. Open the Live Data Window

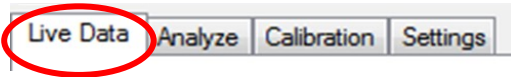

2. Create a clean baseline before running any calibration samples. Refer to:

4.4: Instrument Preparation

3. To begin the calibration, load and run a sample containing only deionized water. Refer to:

4.5: Loading a Sample

4.6: Running A Sample

3. Load and run a minimum of four calibration standards of the selected analytes. The samples should be of varying concentrations and should be run in order from low to high concentrations. See Section 6.1 for sample preparation.

4. For each of the calibration standards, record the concentrations in the Notes window. This will help identify the files during analysis and calibration. All of the system configuration parameters are automatically stored.

Notes

FROG-0101:Ta=300, Tb=120, Tc=30, Ct=60, Ht=100, collect=60, clean=4, presettle=4, settle=2, fire=6; Pump=82%, 44%

Write sample mix and concentration and other notes here

After the instrument has completed running the four (or more) calibration standards, go to the Analyze Window in Ellvin™ to analyze the instrument response data.

C. Analyze the Data

In this window Ellvin™ analyzes the stored instrument response data to create the information needed for calibration.

1. Open the Analyze Window

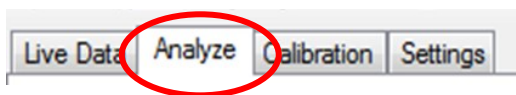

2. Click on the OPEN button to access a list of previously run sample files. (Figure 6.3-1)

(See Section 5.2.1 for details)



3. Select the calibration sample file desired for data analysis. The files are labeled by the *time* they were created and the LOG number.

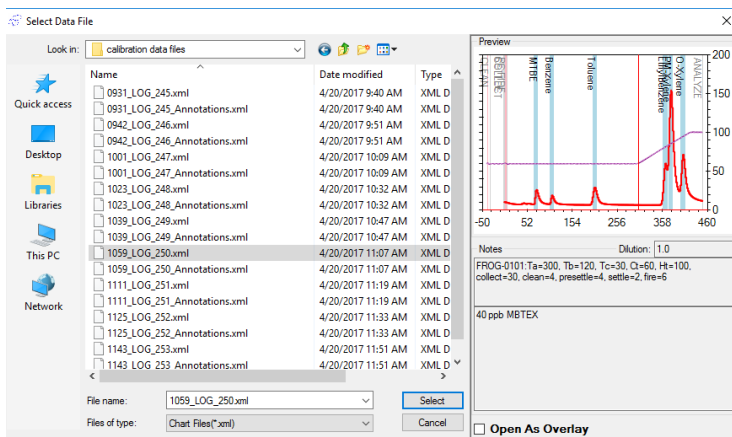

Figure 6.3-1: Open Sample Files

6.3. Calibration Procedure Continued

- In the Analyze Window, click on the Integrator 2 button to integrate the sample peaks in the chromatogram.
(Refer to Section 5.2.3 for detailed instructions on using the Integrator 2)

The results of the data analysis are displayed on the chromatogram and in the Data Grid. (See Figure 6.3-2).

The example shown in Figure 6.3-2 is for a sample of MBTEX. Each peak corresponds to an analyte in the MBTEX mix. Analytes may be run one at a time to determine or confirm retention times. (In this figure, Peak #1 is MTBE which was included in the mix). The third peak at 206 seconds is toluene. This could be confirmed by running toluene by itself.

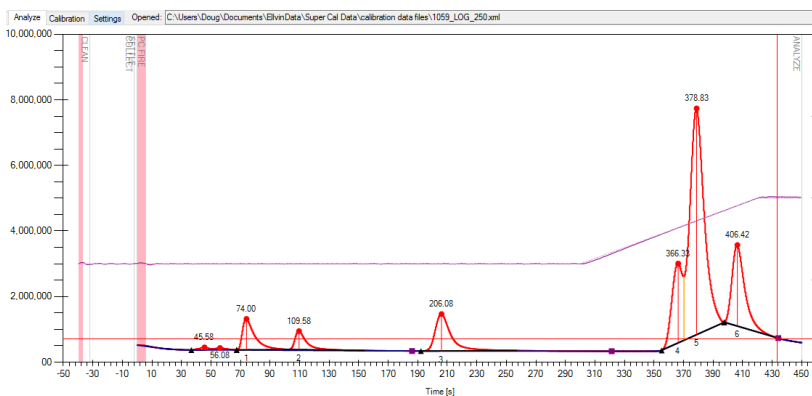

Double left click mouse here and your list of analytes will appear.

Results						
Analyte	Peak	Time	Height	Area	Concentration	Final Conc.
▼	1	74	943314	9103606		
▼	2	109.58	563181	4998146		
▼	3	206.08	1124118	13929884		
▼	4	366.33	2415692	19802018		

Figure 6.3-2: Analysis Chromatogram and Data Grid

D. Calibrate the Instrument

In this section, the data analyzed in Section C is transferred to the Calibration Window. Elvin™ uses the data to calibrate the instrument for each analyte.

1. To assign peak data to an analyte name, double left click the drop-down arrow under Analyte on the Data Grid. A List of Analytes previously recorded in the Section A of the Calibration Procedures appears.
2. Left click on the analyte to assign that name to the corresponding peak.
3. Left click to highlight a row then right click, and a pop-up appears. Left clicking the Identified Analyte will copy the peak information to the calibration table. A pop-up window will appear asking if the selected data is to be copied to the calibration file. Click 'yes'. Continue to match all the peaks with an analyte to the calibration file. Holding the shift key down will allow multiple analytes to be selected and copied to calibration simultaneously.

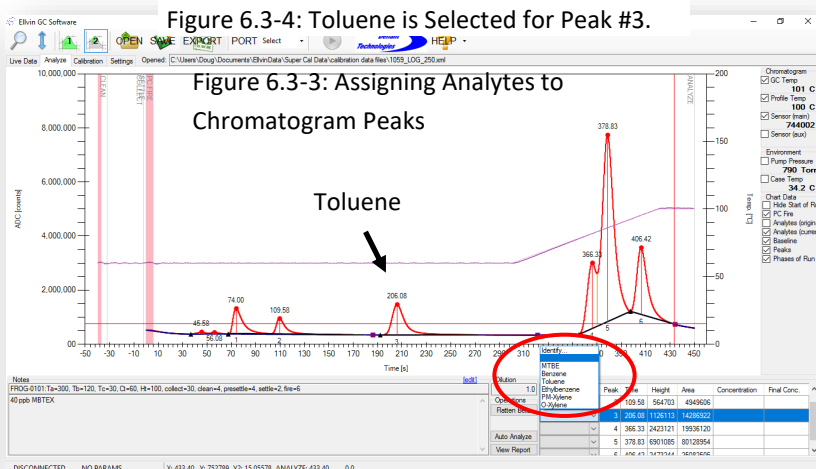
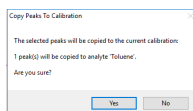
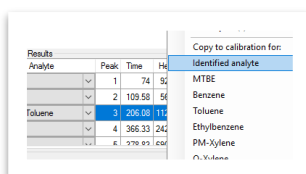

6.3. Calibration Procedure Continued

- To view the imported data, open the Calibration Window, click on List of Analytes, and select the desired analyte. The imported data for this analyte will be displayed

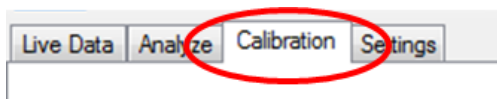

In the example in Figure 6.3-5, Toluene has been selected.

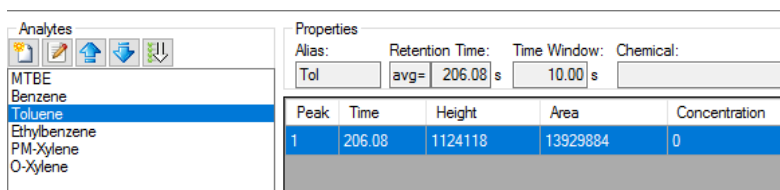
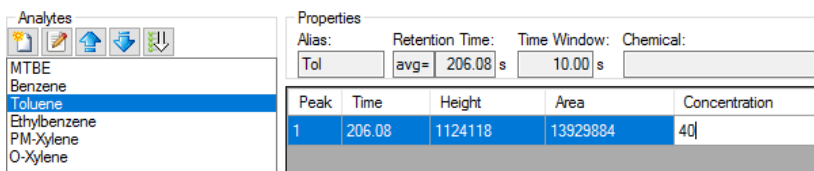

Figure 6.3-5: Select the Desired Analyte from the List of Analytes



- In the Calibration Window, enter in the corresponding concentration for the calibration standard in the column titled "Concentration". In this case, the toluene concentration was edited to be 40 because a 40 ppb standard was used in creating the chromatogram. Standard concentrations were recorded in the Notes window in Section B of the Calibration Procedures. (See B-4.)

Repeat Steps C-1. through D-5. of the Calibration Procedures to import and enter all the standard data to the Calibration Window.

The Correlation Chart and Equations (Section 6.2.2) will appear after the first point is imported into the Calibration Window. The single linear point fit will be automatically forced through zero.

Curve Fit Options

Area Linear

Force Through Zero

Curve Fit Results

Equation: $y = Ax^2 + Bx + C$

Quad R²: 0.0

Equation: $y = 2.8715E-06x + 0$

Linear R²: 1.00000

DOWNLOAD CALIBRATION TO DEVICE

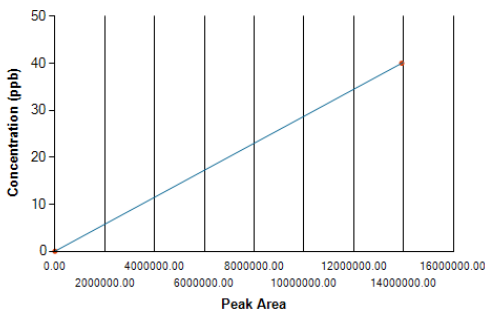

As data points are added, correlation equations are generated by the Ellvin™. A graph of the data points and the curve fit will be displayed in the calibration window. The user can now inspect the fit equation.

Downloading the Calibration to the Instrument

Connect the instrument to Ellvin™ with the USB cable. Refer to:

4.2: Connecting to Computer/Ellvin™

1. All analytes listed in the calibration should show a R² correlation close to 1.0. The closer the R² value is to 1.0, then the better the software can calculate the concentration of an unknown sample.

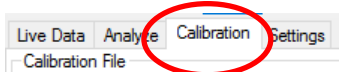

2. Open the Calibration Window.
Continued next page.

6.3. Calibration Procedure Continued

- Click on 'Download Calibration to Device'

DOWNLOAD CALIBRATION
TO DEVICE

- A popup with several different options will appear. By default the software will set to download the calibration file currently loaded in the calibration tab. Select the appropriate option and then click "set" to download the calibration to the FROG.

Set Instrument Calibration



Clear the currently loaded calibration on the instrument. Then:

No calibration is downloaded onto the instrument.

Download the calibration from this file:

Download what is currently open on the Calibration tab:

Progress:

Set

- This will allow the instrument to estimate the concentration of analytes uploaded into the calibration using the peak height linear function.

NOTE: The Ellvin™ software can compute concentrations using either peak height or area under the peak. However, when the instrument is running independently, its processing power is more limited, so peak height and a linear data fit are used in calculating concentrations.

SECTION 7: MAINTENANCE

7.1. ROUTINE CLEANING

It is important to clean the FROG-5000™ after analyzing samples in order to prevent cross-sample contamination.

The FROG-5000™ **does** need to be cleaned if:

- **More than one type of analyte** is being tested. The user must clean the instrument between sets of the different analytes.
- **A high concentration is introduced.** If the user observes large peaks in the chromatogram, the instrument should be cleaned prior to analyzing a sample.

The FROG-5000™ **does NOT** need to be cleaned immediately if:

- **Same analyte** is being tested. The user can run a set of samples of the same analyte from a LOW concentration to a HIGH concentration, consecutively. The user cleans the instrument at the end of the set.
- Rinsing the sparge bottle and syringe between uses is always recommended.
- **The baseline is clear.** If no peaks are observed in the chromatogram, cleaning is not necessary.

To clean the instrument, perform the following procedures:

4.4: Instrument Preparation

The instrument is clean when a clean baseline has been achieved. This means that only small waves appear in the chromatogram (see Figure 7.1-1 on next page)

Section 7.1: Maintenance Continued

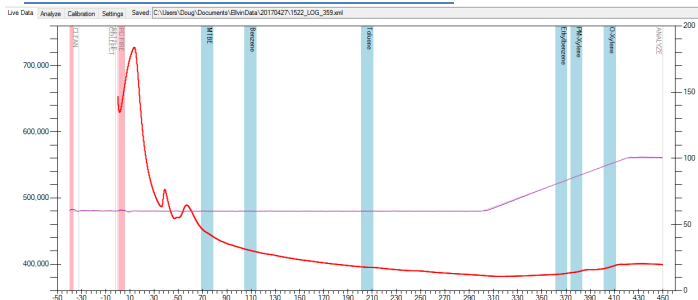

Figure 7.1-1: Chromatogram of a clean baseline. The small peaks around 40 and 60 seconds will not matter if chemicals of interest do not elute at these times. Even if a chemical in the sample elutes at say 60 seconds, the peak would be subtracted in the calibration if this small peak is a constant area between runs.

7.2 CLEANING THE SCRUBBER

It is recommended to clean the carrier gas scrubber every three months, or as needed to create a clean baseline.

Supplies needed to clean the scrubber include:

1. *Clean Activated Carbon
2. *Clean Molecular Sieves
3. 3/32" allen wrench

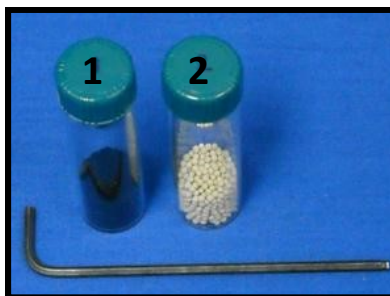

Figure 7.3-1: Supplies needed.

***NOTE:** Replacement activated carbon and molecular sieves may be purchased, premeasured and cleaned, through Defiant Technologies, Inc.

Activated Carbon, Part # DT-FG4K-AC-1

Molecular Sieves, Part # DT-FG4K-MS-1

1. Remove the four corner 4-40 screws with the 3/32" allen wrench.
2. Lightly pull the scrubber off the FROG; place any O-rings back in place if they come out.

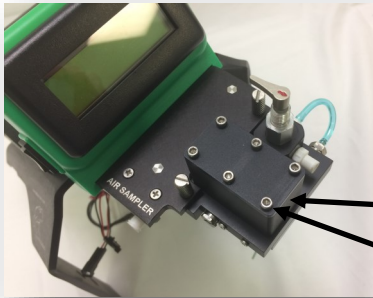
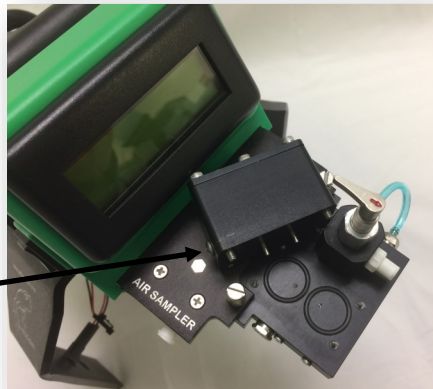

Figure 7.3-2: Carrier gas scrubber is removed by taking out the 4 corner screws with the 3/32" allen wrench.

Carrier Gas Scrubber

Corner screw

3. The Carrier Gas Scrubber only goes on in one orientation.
 - The small screw in the side of the block faces the display when the block is properly oriented.
 - There are two chambers in the block. The back chamber (closest to the display) contains molecular sieve. The front chamber holds activated carbon.



Small screw must face the display when scrubber is installed.

Figure 7.3-3: Carrier Gas Scrubber removed from the Sparge Block.

7.2 Cleaning the Scrubber Continued

4. Hold the scrubber lid-side up and remove the two, center position, 4-40 screws with the 3/32" allen wrench.

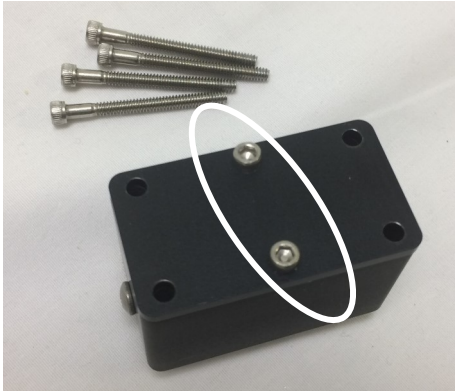

Figure 7.3-4: Two Center Screws hold the lid on the scrubber block.



Note: Glass wool packing is in each of these tubes. The wool prevents carbon from entering the sparge manifold. The wool should not be removed.

Figure 7.3-5 Open scrubber

5. Remove the scrubber lid; put any O-rings back in place if they come out.

6. Dispose of dirty activated carbon and molecular sieves.
7. Use a paper funnel to put new activated carbon into the front chamber.
8. Use a paper funnel to put new molecular sieves into back chamber.
9. Replace the lid.
10. Replace the two, center position, 4-40 screws and snug them tight with the 3/32" allen wrench.
11. Place the scrubber back onto FROG. Make sure small screw in the side faces the display and the bottom tubes slide into the proper holes in the sparge manifold.
12. Replace the four corner 4-40 screws and snugly tighten with the 3/32" allen wrench.
13. There should be NO gap between the sparge manifold and the scrubber block! (Figures 7.3-6 and 7.3-7)
14. To fix space in between, remove the block and make sure O-rings are in the proper position.

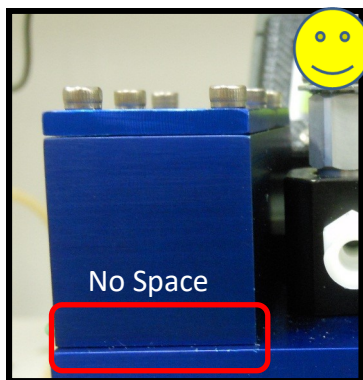

Figure 7.3-6:
Correct scrubber position.

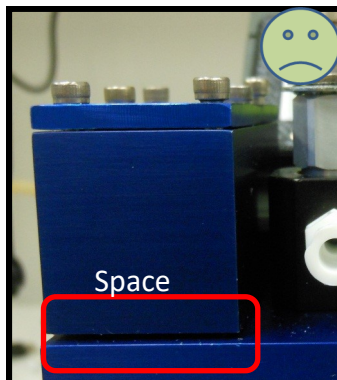

Figure 7.3-7:
Incorrect scrubber position.

This page is intentionally
left blank.

SECTION 8: TROUBLE SHOOTING

8.1. INVERTING THE FROG WITH WATER IN THE SPARGE BOTTLE

If the FROG has been inverted with water in the sparge bottle, it is likely that water will enter the sparge manifold.

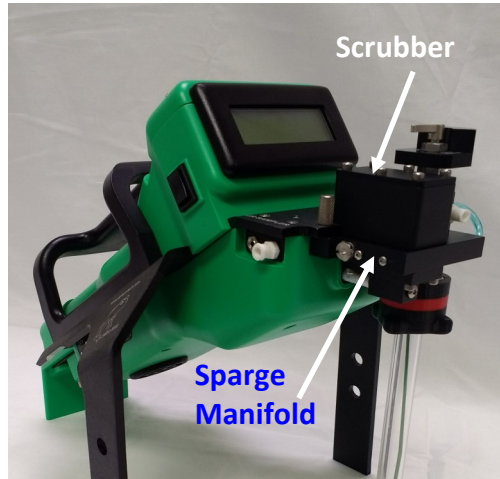

If the FROG was not running at the time, it is unlikely that the water went very far through the manifold. Below is a transparent view of the sparge block that may aid in performing steps on the following page.

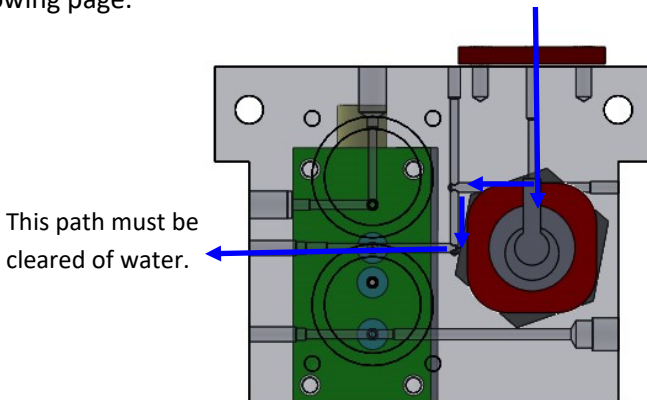



8.1. Inverting the FROG Continued

1. Remove the sparge bottle and turn the load/analyze valve handle to RUN AIR. Connect a clean, dry syringe to the exhaust port from the gas module and push air through the port. DO NOT use a compressed gas can.



Figure 8.1-2: Pushing water from the plumbing.

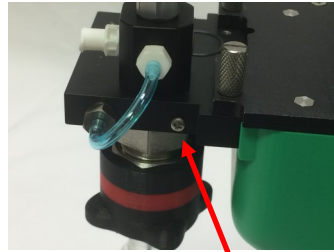

Sealing Screw #1

2. Remove sealing screw #1 and re-install an empty sparge bottle. Push air again through the exhaust port with the clean, dry syringe.
3. Replace sealing screw #1 and remove sealing screw #2 on the opposite side of the sparge manifold. Push air again through the exhaust port with the syringe.
3. Replace sealing screw #2 and remove the scrubber block. Look for water. Push air again through the exhaust port with the syringe.

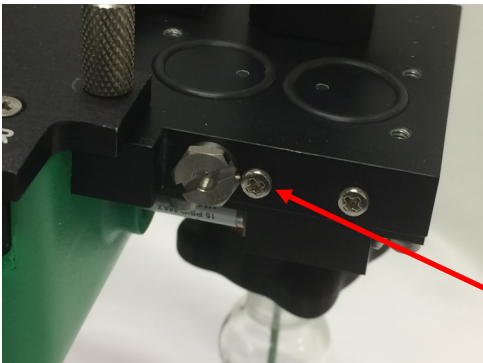

Figure 8.1-3: Pushing water out of the sparge manifold.

Sealing screw #2.

5. If there was water under the carrier gas scrubber block, the scrubber materials will need to be removed and replaced.

Re-install the carrier gas scrubber block and remove the syringe from the exhaust port. Remember that the small screw in the side of the scrubber block must face the display. (See Section 8.1.3, Cleaning the Scrubber for procedure details)

6. Press the start button on the FROG and allow the system to run 20 seconds through the collect then turn the FROG off . If you do not see water coming from the exhaust port, everything is probably fine.

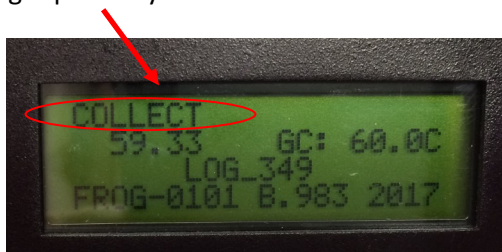

7. Load a blank sample (deionized water) and run a Collect Cycle (make sure the Load/Analyze Valve is turned to RUN WATER).

Look for bubbles in the sparge bottle.

- If bubbles appear, the liquid was successfully removed from the sparge manifold.
- If bubbles do not appear, then contact Defiant Technologies for consultation.



Figure 8.1-4: Look for Bubbles in the sparge bottle.

8.1. Inverting the FROG Continued

8. Perform some analyses with clean water and see if the chromatograms look normal.

Refer to:

4.6: Running A Sample

9. Contact Defiant technologies or your local representative for further assistance if the chromatograms continue to look erratic. Let us know what happened, we can fix it much quicker that way. Contact information is at www.defiant-tech.com.

Email: info@defiant-tech.com

Phone: 505-999-5880

Section 8: Troubleshooting Continued

8.2. DEGRADING CHROMATOGRAPHY : SCRUBBER IS NOT SECURED PROPERLY

If the Chromatography is degrading over time:

Check the scrubber block.

The scrubber block may NOT be sealed correctly.

There should be no space in between the scrubber block and the scrubber holder.

(Figures 8.2-1 and 8.2-2)

(Refer to Section 8.1.3, Cleaning the Scrubber)

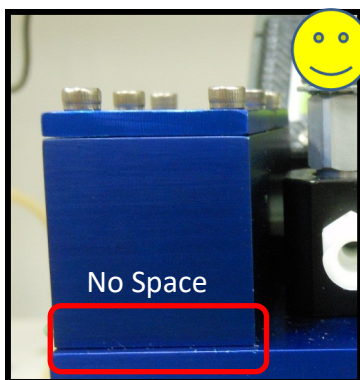

Figure 8.2-1:
Correct scrubber position.

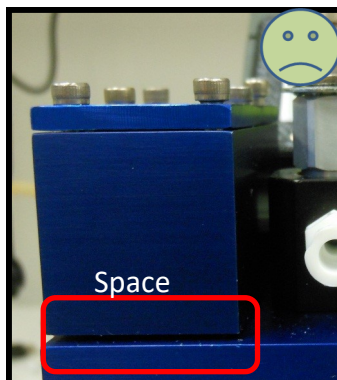

Figure 8.2-2:
Incorrect scrubber position.

Performance can also be affected by high concentrations of analytes, or high background concentrations in the surrounding environment (See next section).

Section 8: Troubleshooting Continued

8.3. CANNOT ACHIEVE A CLEAN BASELINE

If a clean baseline cannot be achieved after **repeatedly** following the procedures in Sections 4.4.1 and 4.4.2 (Rinsing the Instrument and Creating a Clean Baseline), contamination problems may stem from having loaded a sample with a high concentration of analyte, or from the presence of airborne contaminants.

NOTE: A small peak at the beginning of the chromatogram is normal for a clean baseline.

Complete the following procedures to eliminate contamination interfering with a clean baseline.

Perform procedure 4.4 while connected to Ellvin™ and using warm deionized water. Refer to:

4.4: Instrument Preparation

Repeat this procedure up to three times if necessary to achieve a clean baseline.

Airborne Contaminants

If it is still NOT possible to achieve a clean baseline when running water samples, there may be contaminants present in the ambient air. An airborne contaminant can enter the sparge bottle when it is lowered. This volume of air cannot be scrubbed and will be collected by the PC.

Airborne contaminants can also enter through the pump with the sparge and carrier gas though these are largely removed by the scrubbers.

Solutions:

1. Either circulate air in the testing environment, or move to a new location, then perform:

4.4: Instrument Preparation

If a clean baseline is still not achievable,

2. Clean the scrubber.
(See Section 7.3)

If a clean baseline is still not achievable,

3. Provide an activated charcoal trap at the pump inlet (V).



Section 8: Troubleshooting Continued

8.4. COOL FEATURES (CONTINUOUS OPERATION)

Continuous Sampling and Analysis Mode

If the FROG-5000™ is not connected to a computer, a continuous run cycle can be initiated depressing the upper part of the black toggle switch when the power switch is simultaneously turned on. The next time the toggle is depressed, the unit will begin continuous cycling. No chromatography results will be displayed on the screen. End the cycle by switching the power off. All chromatographs can be recovered from the internal micro-SD card.



When the FROG is connected to Ellvin™, it can be set to cycle continuously by simply holding the shift key down when the start button is pressed. If this action is initiated, a pop-up window appears where cycle numbers and time delays can be set. Remember to account for the cooldown time in setting interval times.

If an interval is not set, the cycle will restart when the GC cools to its low temperature setting

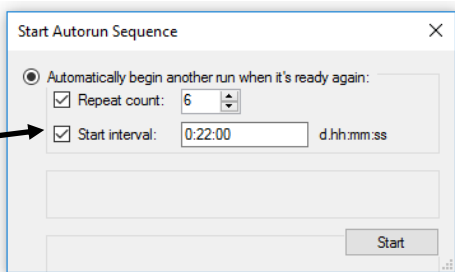

Continuous cycling is particularly useful in monitoring air or running water blanks for cleaning the instrument.

Section 8: Troubleshooting Continued

8.5. REALLY USEFUL FEATURES

Frog Doctor

Frog-Doctor provides the ability to turn valves and pumps on and off without performing sample runs. The Frog Doctor button appears in both the live data and the Settings windows.

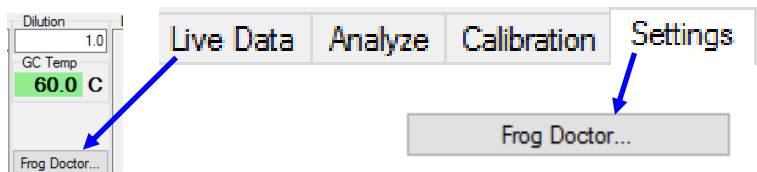

The FROG must be communicating through ELLVIN for Frog Doctor to work. If the FROG is connected and the Frog Doctor button is clicked, a pop-up menu is displayed with several options as displayed in Figure 8.5.1.

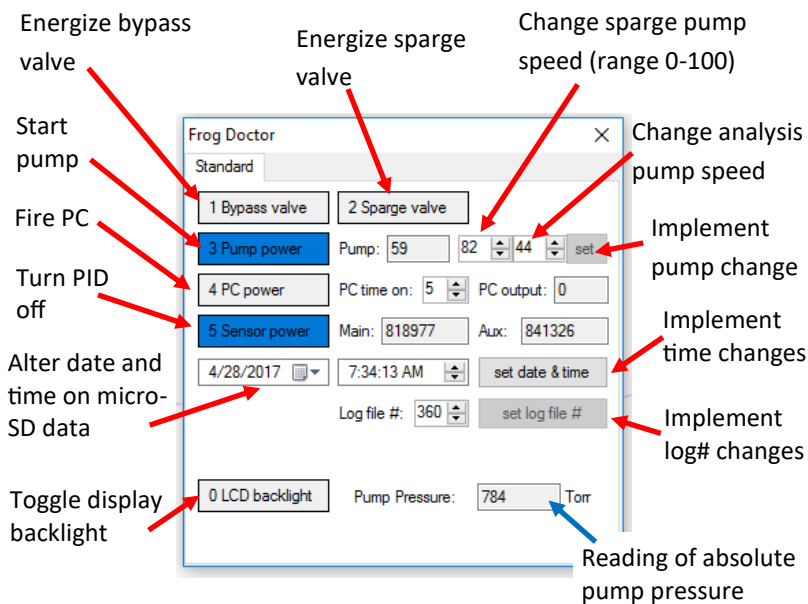

Figure 8.5.1. Features of Frog Doctor

SECTION 9: CARE OF THE LI-PO BATTERY

The FROG-5000 uses 10.8 volt lithium polymer batteries that are manufactured by Inspired Energy. Check their website for additional information on the battery, www.inspired-energy.com. In particular, check the website at www.inspired-energy.com/shipping.html for up to date information on shipping the battery. The exact part number for the battery is NF2040HD34.

9.1.1. Handling

- Avoid shorting the battery and do not immerse in water.
- Do not disassemble or deform the battery
- Do not expose to, or dispose of the battery in fire.
- Avoid excessive physical shock or vibration.
- Keep out of the reach of children.
- Never use a battery that appears to have suffered abuse

9.1.2. Storage: Store in a cool, dry and well-ventilated area.

9.1.3. Disposal: Dispose of in accordance with local regulations.

9.2. General Specifications: Nominal Voltage: 10.8V, Rated Capacity: Initial capacity is 6460mAh

9.3.1 Shipping: check www.inspired-energy.com/shipping.html for up to date shipping information. As of this time this manual was written, the guidance is:

- Battery may be shipped in the equipment by ground or cargo aircraft with no special packaging labels
- Battery cannot be shipped on passenger aircraft as checked baggage. It must be removed from the Frog, packed so it cannot crush or short, and hand carried by the passenger on the aircraft.
- If the battery is shipped outside of a unit it should have less than a 30% charge before transport. Run unit until only one bar shows on charge indicator, then remove the battery and pack for shipping.
- These guidelines may not apply for all countries and the user should check for local requirements for shipping lithium polymer batteries.



Remove both thumbscrews then slide heel straight back to remove



Battery slips out back

SECTION 10: POSITIONING OF THE SPARGE NUT

There is a stop on the sparge bottle nut cover that prevents the nut from being completely removed or overtightened. This prevents the accidental loss of the Teflon™ ferrule parts that seal the sparge bottle to the system. The ferrule parts will compress over time and it will be necessary to reposition the nut stop to allow the ferrule to seal better against the sparge bottle or air sample adapter. To reposition the nut stop, simply slide the plastic sparge nut cover off of the hex nut and rotate it one or two positions counter-clockwise. Press the cover back on the hex nut and check that the nut will tighten better on the sparge bottle. The Teflon™ ferrule is compliant so it is not necessary to tighten hard against the glass sparge bottle. The nut should provide a snug fit to prevent gas from leaking from the system when the unit is running. If the chromatography peaks appear to have shifted to the right (later in time), it is possible that gas is leaking from the system at the sparge bottle nut.

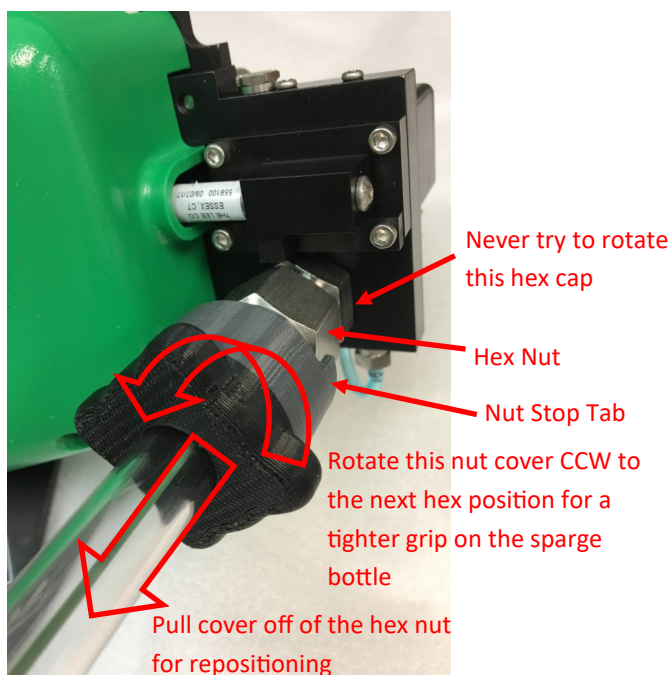





Repositioning the sparge nut stop.







This page is intentionally
left blank.

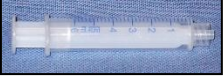

APPENDIX I: AVAILABLE ACCESSORIES/SPARE PARTS

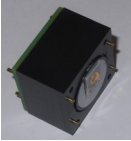
Item	Defiant Part #	Description
FROG-5000 Warranty and Service Contract	DT-FG-SERV-1	One year service contract / maintenance program.
Activated Carbon 	DT-FG-AC-1	Replacement Activated Carbon for FROG air scrubber. Pre-measured and pre-cleaned.
Molecular Sieves 	DT-FG-MS-1	Replacement Molecular Sieves for FROG air scrubber. Pre-measured and pre-cleaned.
Sparge Bottle 	DT-FG-SBGN-1	Sparge Bottle with globe neck.
Sparge Bottle Nut 	DT-FG-SBN-1	Nut to connect Sparge Bottle to instrument.
5 mL Glass Syringe 	DT-SYGG-1	5mL glass syringe with Luer Lock tip.



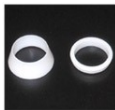
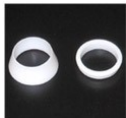

APPENDIX I: AVAILABLE ACCESSORIES/SPARE PARTS

Item	Defiant Part #	Description
5mL Plastic Syringe 	DT-FG-SYGP-1	5mL plastic syringe with Luer Lock tip.
60mL Rinsing Syringe 	DT-FG-SYGN-1	60mL syringe with Luer Lock tip for rinsing Sparge Needle.
Luer Lock Inlet 	DT-FG-LL-1	Attachment for syringe.
PID Assembly 	DT-FG-PID-1 DT-FG-PID-2 DT-FG-PID-3	PID Assembly for normal sensitivity (1) low sensitivity (2) high sensitivity (3)
Tool Kit 	DT-FG-TK-1	Assorted tools for maintenance of FROG
Sparge Needle Cover 	DT-NEEDCOV-1	Sparge Tube Guard for covering Sparge tube in shipping container



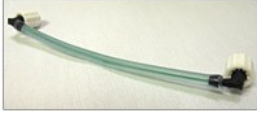

APPENDIX I: AVAILABLE ACCESSORIES/SPARE PARTS

Item	Defiant Part #	Description
Ferrules for Sparge Bottle Nut 	DT-FG-SBNF-1	Replacement ferrules for the Sparge Bottle Nut, 1/2" ferrule set.
Ferrules for Air Sample Bag Adapter for FROG Air Sampler 	DT-FG-SBNF-2	Replacement ferrules for the Air Sample bag adapter for the FROG's air sampler, 3/16" ferrule set, Teflon.
Sparge Line 	DT-FGSL-1	Sparge Line with Connectors.
Valve Assembly 	DT-FG-VLV-1	Replacement valve assembly for FROG-5000.
Air Sampler Wand 	DT-FG-AS-WAND	Replacement air sampler wand.
1/16-3/16 Adapter 	DT-AS-316-ADAPTER	Replacement 1/16-3/16 adapter for connecting the air sampler transfer line to a Tedlar bag.

APPENDIX I: AVAILABLE ACCESSORIES/SPARE PARTS

Item	Defiant Part #	Description
Air Sample Transfer Line 	DT-AS-TRAS-LINE	Replacement transfer line for connecting air sampler.
Air Sampler Coupler Line 	DT-AS-COUP	Replacement couple line for connecting the air sampler box to the Frog.
Battery 	DT-BT- NF2040HD34-1	Rechargeable NiMH Battery 10.8V, 6460 mAh.
Serial Data Cable 	DT-DC-1	Ellvin (software) communication cable (All-in-one Data Cable)
Power Supply 	DT-FG5K-PS12V-1	Power Supply 12V 6.67A
Pump 	DT-PU-1	Replacement air pump.

APPENDIX I: AVAILABLE ACCESSORIES/SPARE PARTS

Item	Defiant Part #	Description
<p style="text-align: center;">Activated Carbon Filter Tube</p> 	DT-FG-CFT-1	Replacement air scrubber for cleaning VOCs from sampled air
<p style="text-align: center;">Activated Carbon Filter Tube Adapter</p> 	DT-FG-CFTAB-1	Brass adapter for connecting carbon trap to FROG air sample tube
<p style="text-align: center;">Air Sampler Syringe Filter and Adapter</p> 	DT-AS-FIL-1	Air Sampler Particulate Filter and Adapter
<p style="text-align: center;">Air Sampler Syringe Filter</p> 	DT-AS-FIL-2	Air Sampler Particulate Filter



This page is intentionally
left blank.

APPENDIX II: DETECTABLE CHEMICALS

Common Chemicals Detectable by FROG 4000	CAS Number	IE (eV)
1,1-Dichloroethene	75-35-4	10.0
1,2,4-Trichlorobenzene	120-82-1	9.0
1,2-Dibromoethane	106-93-4	10.4
1,2-Dichlorobenzene	95-50-1	9.1
1,3-Dichlorobenzene	541-73-1	9.1
1,4-Dichlorobenzene	106-46-7	9.0
1,4-Dioxane	123-91-1	9.2
1-Propanol	71-23-8	10.2
2-Butanone (MEK)	78-93-3	9.5
2-Chloroethanol	107-07-3	10.5
2-Hexanone	591-78-6	9.4
2-Pentanone	107-87-9	9.4
2-Picoline	109-06-8	9.4
2-Propanol	67-63-0	10.2
4-Methyl-2-pentanone	108-10-1	9.3
Acetone	67-64-1	9.7
Acrolein	107-02-8	10.1
Allyl alcohol	107-18-6	9.6
Allyl chloride	107-05-1	10.1
Benzene	71-43-2	9.2
Benzyl chloride	100-44-7	9.1
Bromoacetone	598-31-2	9.7
Bromodichloromethane	75-27-4	10.6
Bromoform	75-25-2	10.5
Bromomethane	74-83-9	10.5
Carbon disulfide	75-15-0	10.1
Chlorobenzene	108-90-7	9.1
Chlorodibromomethane	124-48-1	10.6
Chloroethane	75-00-3	10.0
Chloroprene	126-99-8	8.8

APPENDIX II: DETECTABLE CHEMICALS CONTINUED

Common Chemicals Detectable by FROG 4000	CAS Number	IE (eV)
Crotonaldehyde	4170-30-3	9.7
Dibromomethane	74-95-3	10.5
Diethyl ether	60-29-7	9.5
Diisopropyl ether (DIPE)	108-20-3	9.2
Epichlorohydrin	106-89-8	10.6
Ethanol	64-17-5	10.6
Ethyl acetate	141-78-6	10.0
Ethyl tert butyl ether	637-92-3	9.4
Ethylbenzene	100-41-4	8.8
Ethylene oxide	75-21-8	10.6
Iodomethane	74-88-4	9.5
Isobutyl alcohol	78-83-1	10.1
Isopropylbenzene	98-82-8	8.8
Methacrylonitrile	126-98-7	10.3
Methyl methacrylate	80-62-6	9.7
Methyl tert-butyl ether	1634-04-4	9.2
m-Xylene	108-38-3	8.6
Naphthalene	91-20-3	8.1
n-Butanol	71-36-3	10.0
Nitrobenzene	98-95-3	9.9
n-Propylamine	107-10-8	8.8
o-Toluidine	95-53-4	7.4
o-Xylene	95-47-6	8.6
Propargyl alcohol	107-19-7	10.5
p-Xylene	106-42-3	8.5
Pyridine	110-86-1	9.3
Styrene	100-42-5	8.4
t-Butyl alcohol	75-65-0	10.3
Tetrachloroethene	127-18-4	9.3
Toluene	108-88-3	8.8

APPENDIX II: DETECTABLE CHEMICALS CONTINUED

Common Chemicals Detectable by FROG 4000	CAS Number	IE (eV)
trans-1,2-Dichloroethene	156-60-5	9.7
Trichloroethene	79-01-6	9.5
Vinyl acetate	108-05-4	9.2
Vinyl chloride	75-01-4	10.0
β-Propiolactone	57-57-8	9.7

NOTE: This list is by no means exhaustive. The FROG-5000™ uses a 10.6eV lamp, so many analytes with ionization energies below 10.6eV may be detectable with the instrument.



Notes



Notes



Notes

